

**Independent
guide to the
BBC MICRO!**

THE MICRO USER

Volume 2
Number 7
September 1984
£1.25

WIN The very latest
language ROM



-Page 79

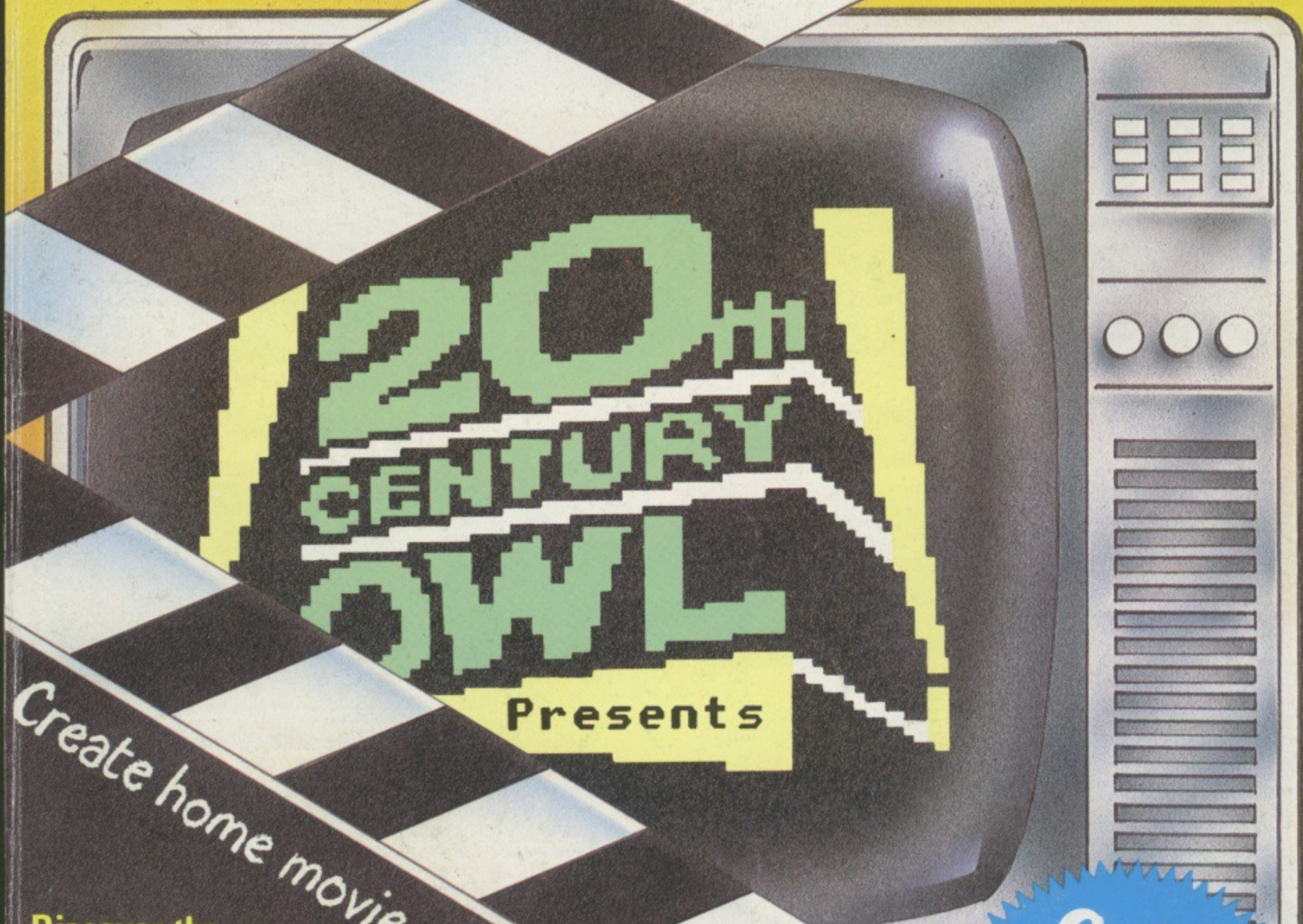

Presents

Create home movie titles with your micro!

**Discover the
hidden power of the
6502 second processor**

**LOG-ON: 16 page section
on using your BBC Micro to
talk to other micros, Prestel...
and even Big Brother Mainframe**

GAMES

**Do battle with
Hugo the Villain!
Control spheres
in Rollerball!**

SPECIAL OFFER!
Order both directly from us and deduct £1 from each.

TWO SENSATIONAL NEW RELEASES FROM SUPERIOR SOFTWARE

BBC MICRO

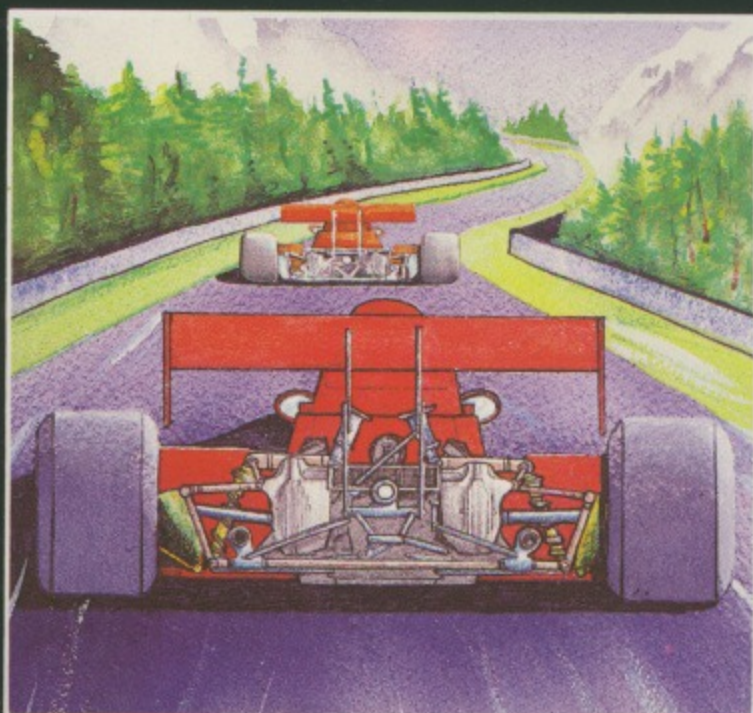

OVERDRIVE (32K)

£7.95

A highly-addictive multi-stage 3D race game. You steer your car left and right, accelerate and decelerate as the opposing cars weave about the road. There are five different stages including night, snow, desert, and riverside scenes. To qualify for the next stage, you must finish in the top twelve. Incredible graphics give the impression that you really are taking part in the race. Highly recommended, and destined to become another top-seller for Superior Software.

●●●NEW RELEASE●●●

OUR PROGRAMS ARE NOW AVAILABLE FROM OVER 1000 OUTLETS THROUGHOUT THE UK AND OVERSEAS. SEE YOUR LOCAL DEALER!

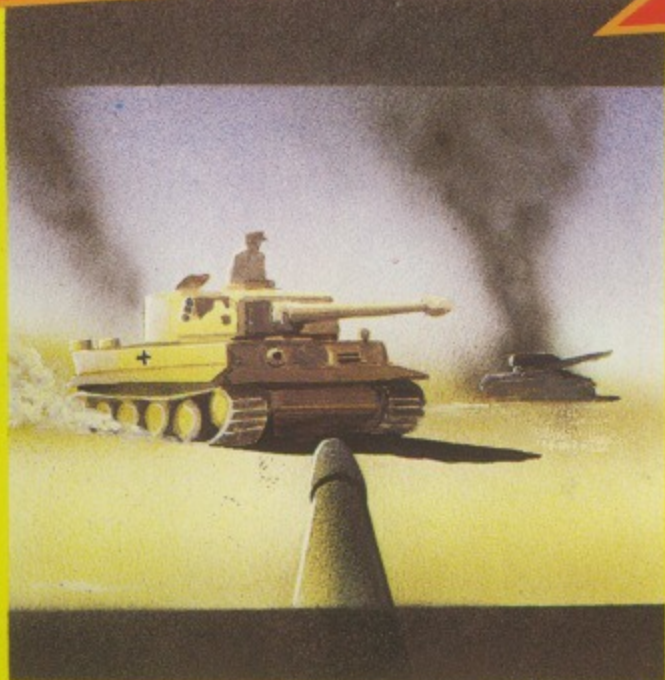

BATTLE TANK (32K)

£7.95

An excellent game, made possible on the BBC computer only by the unique use of a dual-screen display and specially written plotting routines. You are a tank gunner looking out onto a mountain plateau. You see the distant mountains and the pyramid obstacles – and also the enemy tank. Your task is to shoot it before it shoots you. A scanner is displayed in the bottom right-hand corner of the screen. This displays the position of the enemy tank relative to you. You can then turn to get the tank in view. The next stage is to position the tank in the rectangular viewfinder by fine adjustments of your controls. (KEYBOARD or JOYSTICKS)

●●●NEW RELEASE●●●

WE PAY UP TO 20% ROYALTIES FOR HIGH QUALITY BBC MICRO AND ELECTRON PROGRAMS



SUPERIOR SOFTWARE LTD.

Dept. BMU5, Regent House,
Skinner Lane, Leeds 7
Tel: 0532 459453

OUR GUARANTEE

- (1) All our software is available before we advertise.
- (2) All our software is despatched within 48 hours by first-class post.
- (3) In the unlikely event that any of our software fails to load, return your cassette to us and we will immediately send a replacement.

Computerama

the source

ROM SOFTWARE	INC VAT
Wordwise	39.95
View	59.00
Printmaster	32.95
Caretaker	32.95
Disc Doctor	32.95
Termi (terminal emulator)	32.95
Graphics Extension	32.95
DFS. The Upgrade	27.95
Acorn Speech System Upgrade	55.00
HCCS Forth	39.95
HCCS Logo Forth	67.85
HCCS Pascal	57.00
HCCS Excal	74.75
ROM Expansion Board (ATPL) The Best!	43.70

BOOKS	NO VAT
BBC Micro Disc Companion	7.95
Creative Graphics	7.50
Graphs & Charts	7.50
Lisp Manual	7.50
Forth Manual	7.50
BCPL Manual	15.00
Discovering BBC Micro Machine Code	6.95
BBC Micro Disk Manual Disk Systems For The BBC Micro	1.95

MICRO POWER	INC VAT
Killer Gorilla	7.95
Cybertron Mission	7.95
Cosmic Combat	7.95
Chess B	7.95
Danger UXB	7.95
Escape Moonbase Alpha	7.95
Felix in Factory	7.95
Felix & Fruit Monsters	7.95
Nemesis	7.95
Bumble Bee	7.95
Wizards Challenge	7.95
Jet Power Jack	7.95
Positron	7.95
Demon Decorator	6.85
Alien Swirl	7.95
Alien Destroyers	7.95
Space Jailer	7.95
Ghouls	7.95
Moon Raider	7.95
The Mine	7.95
Hell Driver	7.95
Labyrinths of LaCoshe	7.95
Zarm	7.95
Blockbuster	7.95
Rubble Trouble	7.95
Frency	7.95
Stock Car	7.95

SUPERIOR SOFTWARE	INC VAT
Hunchback	7.95
Overdrive	7.95
Battletank	7.95
Cosmic Kidnap	7.95
Star Battle	7.95
Moon Mission	7.95
Percy Penguin	7.95
Boris In The Underworld	7.95
Rocky	7.95
Spitfire Command	7.95
Crazy Painter	7.95
Road Racer	7.95

OPUS	INC VAT
Dogfight	8.95

BUG-BYTE	INC VAT
Twin Kingdom Valley	9.95

DYNABYTE	INC VAT
Pool	7.95
Horse race	7.95
Lamming Syndrome	7.95
Corporate Climber	7.95

BBC/ACORNSOFT	INC VAT
Algebraic Manipulation	9.95
Business Games	9.95
Castle of Riddles	9.95
Creative Graphics	9.95
Countdown to Doom	9.95
Forth	16.85
Graphs & Charts	9.95
Hopper	16.85
Lisp	16.85
BCPL (Rom + Disc)	99.95
Missile Base	9.95
Meteors	9.95
Kingdom Of Hamil	9.95
Monsters	9.95
Planetoid	9.95
Rocket Raid	9.95
Snooker	9.95
Sphinx Adventure	9.95
Starship Command	9.95
Tree of Knowledge	9.95
Snapper	9.95
Shirley Conran's Magic Garden	9.95
Personal Money Management	9.95
Draughts and Reversi	9.95
Aviator C/D	14.95/17.25
J C B Digger	9.95
Free Fall	9.95
Carousel	9.95

ACORNSOFT EDUCATIONAL SOFTWARE NOW AVAILABLE	
White Knight II	11.50
Vutype	16.10
Tax Calc	17.25
Beyond Basic	11.50
Toolbox	21.00
Canyon	10.00
Record Keeper	15.00
Doctor Who	10.00
ACORNSOFT MIRLE NOW IN STOCK	P.O.A.

IMAGINE	INC VAT
Pedro	5.50
Cosmic Cruiser	5.50

INVASION SOFTWARE	INC VAT
Eagles Wing	7.95
Spooks and Spiders	7.95
3-D Bomb Alley	7.95
Gunsmoke	7.95
Vortex	7.95
Attack on Alpha Centauri	7.95

VISIONS	INC VAT
Snooker	7.95
Digger	7.95
Daredevil Dennis	7.95
Nifty Lifty	7.95
Demolater	7.95
Pengi	7.95

PSION	INC VAT
Safon Sally	6.95
VuCalc	14.95
VuFile	14.95

MELBOURNE HOUSE	INC VAT
The Hobbit	14.95

COMPUTERAMA SOLID STATE JOYSTICK INTERFACE

* with RAPID-FIRE feature
Now a totally new concept in joystick control for your BBC Micro. Simply plug into the analogue port, and connect ANY Atari type joystick for instant joystick control. FREE keyboard-ONLY game allows joystick control of conversion programme allows joystick control of keyboard-only games. No memory-conflicts with this one - due to our unique Relocatable Code feature. ORDER TODAY. Only a few available. Demand is bound to be high.

ONLY £14.95 + 50p Carriage

TORCH Z80 DISC PACK WITH OVER £1,100 OF SOFTWARE FREE

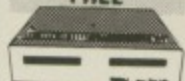

ORDER TODAY - Get the Z80 version of BBC Basic FREE (Was £125) runs BBC Micro programmes up to twice as fast, gives 32K for graphics AND 48K for Basic programme.

NOW ONLY £199 INC. VAT Free Licence UK only

Software includes:
● PERFECT WRITER ● PERFECT SPELLER ● PERFECT CALC ● PERFECT FILES ● TORCH NET
The TORCH Z80 DISC PACK is the most powerful BBC Micro disc upgrade available - it provides 800K of storage plus a Z80 Second Processor running Torch's own CP/M compatible operating system. Clip this ad to your order to receive free 40/80T converter programme.

● NEW TORCH ZEPHYR PACK - Add Torch Power to any 80 track drive. Complete 2nd Processor AND Free Perfect software worth £1000 ONLY

£343 inc VAT



JUKI 6100 DAISYWHEEL PRINTER SAVE OVER £130 FREE 10 Ribbons FREE Printer Cable Paper These items Alone could cost over £80 Elsewhere. COMPLETE PACKAGE Worth £535 COMPUTERAMA PRICE ONLY £399

RING FOR LATEST PRICES, MANY REDUCTIONS EXPECTED

QUICKSHOT II BBC MICRO JOYSTICK

Now with rapid fire Option and Solid State Interface. Optional Relocatable code feature means that it WORKS with more games than any other similar interface. This SELF-CENTERING JOYSTICK, works even with keyboard-only programmes. A sensation at the Micro User Show. More fun - reaches the games other joysticks cannot. Limited supplies of this item.

£19.95 + £1.55 p&p

WE ACCEPT INSTITUTIONAL EDUCATIONAL ORDERS

ATPL SIDEWISE ROM EXPANSION BOARD

- Full sideways Rom
- Expansion to 16 Roms
- 16K Battery backed CMOS Ram option
- No soldering required to fit sideways
- Plug-in-and-go construction - Mounts neatly inside the BBC Micro
- Full buffering of address and data buses - prevents data bus loading problems associated with unbuffered boards
- Pin 1 of on-board sockets are connected properly - No spurious crashes due to this known fault on BBC Micro. Existing sockets on BBC Micro are usable. All Eprom sockets are accessible without removing sideways.



ONLY £43.70 + £1.00 carriage

24 HOUR DESPATCH ON STOCK ITEMS

MAIL ORDER No Stamp Required
Post your order today to
COMPUTERAMA
DEPT MUB FREEPOST
STAFFORD ST16 2BR
OR TELEPHONE OUR MAIL ORDER HOT LINE With your ACCESS or VISA number, we will endeavour to despatch immediately. (0785) 41899.

Call in today - Home Computer Centre for the BBC Micro enthusiast
Send large SAE for further details of any product.
CARRIAGE
Micro's, Monitors, Disc Drives, Printers £8.00. Books £1.00 each
Cassette Decks £2.00. Leads and software 50p item (£1.50 max)

50 P MONEY SAVER! with every order, five pounds worth of moneysaving vouchers

Computerama

STAFFORD
59 Foregate Street
Tel: (0785) 41899

STOKE-ON-TRENT
11 Market Square Arcade,
Hanley Tel: (0782) 268620

SHREWSBURY
13 Castle Gates
Tel: (0743) 60528

HARDWARE CORNER

BBC	INC VAT
ACORN ELECTRON	199.00
BBC Micro Model B	399.00
BBC Micro Model B + Double density DOS	P.O.A.
BBC Micro Disc Upgrade	95.00
BBC Micro A-B Full Upgrade	225.00
BBC Micro Teletext Receiver	1 B.A.
BBC Micro Z80 2nd Processor	1 B.A.
BBC Micro 6502 2nd Processor	104.95
Double Density DOS Upgrade	39.95
Pace DFS	39.95

DISC DRIVES	INC VAT
LVL Dual 100K	340.00
Pace Single 100K	169.95
Pace Single 40/80T D/Sided	282.90
Pace Dual 100K	338.00
Pace Dual 40/80T D/Sided	573.95
Torch Dual 400K Z80 Disc Pack	799.00
Pace 200K 40T D/Sided	243.00
HOBBIT FLOPPY DRIVES	99.95

MONITORS	INC VAT
Microvitec 14" Colour	229.00
Sanyo 14" Colour	269.00
Fidelity 14" Colour Monitor	199.00
Grundig 14" Colour TV/Monitor	309.00
Sanyo 12" Green	89.00

PRINTERS	INC VAT
Epson RX80	269.00
Epson RX80FT	299.00
Epson FX80	389.00
Epson FX100	569.00
Shinwa CP80	229.00
Riteman	286.00
Juki 6100 Daisywheel	399.00

MISCELLANEOUS	INC VAT
Sanyo DR101 Data Recorder	39.95
Sanyo DR202 Data Recorder	44.95
Cassette leads - all types	2.80
Computerama Joystick interface	14.95
Quickshot Joystick (FOR BBC MICRO)	19.95
Printer Cable (Parallel) 1.2 m	9.95
BBC Micro Deluxe Cover	5.95
Light Pen	28.75
Data Cassettes 5 x C20/C15	1.95
The Plug Power Filter	14.95

ORDER A COMPLETE SYSTEM - GET ALL LEADS FREE

MICROBYTE	INC VAT
3D Space Ranger	7.95
Pinball	7.95

CLARES	INC VAT
B-Base	25.00
Replica II (Disc Only)	12.00
Graph Disc	12.95
The Key (Disc Only)	12.95
Shadow/Inspector	1.95
State 40/80T for Discs	7.95

DR SOFT	INC VAT
747 Flight Simulator	8.95
Gorph	7.95

AMCOM	INC VAT
Fortress (C/D)	7.95/11.95
Space Highway	7.95

GEMINI	INC VAT
Business Combination Packs 1, 2, 3, 4	P.O.A.
Data Base	19.95

SOFTWARE FOR ALL	INC VAT
Stock Control (C/D)	19.95/29.95
Invoicing/Statements (C/D)	19.95/29.95
Sales/Purchases (C/D)	19.95/29.95

ADVENTURE INTERNATIONAL	INC VAT
The Hulk	9.95
Adventureland	9.95
Voodoo Castle	9.95
Secret Mission	9.95
Pirate Adventure	9.95

SOFTSPOT	INC VAT
Transistors Revenge	6.95
Heist	6.95

H. SOFT (WATFORD)	INC VAT
Penguin	7.95

ALLIGATA	INC VAT
Spitfire	7.95
Neanderthal Man	7.95
Blogger	7.95

HEWSON	INC VAT
Heathrow Air Traffic Control	7.95

CRL	INC VAT
Test Match	7.95

A&F	INC VAT
Chuckie Egg	7.90
Cylon Attack	7.90
180 1 Darts	7.90

AARDVARK	INC VAT
Zelaga	6.90
Frak!	6.90

ADDICTIVE	INC VAT
Football Manager	6.90

MIRRORSOFT	INC VAT
First Steps With The Mr. Men	9.95

MICRO USER	INC VAT
Micro Olympics	6.90

MICRODEAL	INC VAT
Air Traffic Control	9.95
Space Shuttle (C/D)	7.95/9.95

MRM SOFTWARE	INC VAT
Q-Man	5.70
Q-Man's Brother	5.70
Diamond Mine	5.70
Guy In The Hat	5.70
3D Munchy	5.70
Castle Assault	5.70
Darts	5.70

SOFTWARE PROJECTS	INC VAT
Legion	6.95

MOSAIC	INC VAT
My Secret File	9.95

OCEAN	INC VAT
Mr. Wimpy	6.90

JOE THE LION	INC VAT
Challenger	7.95

VIRGIN	INC VAT
Microbe	7.95

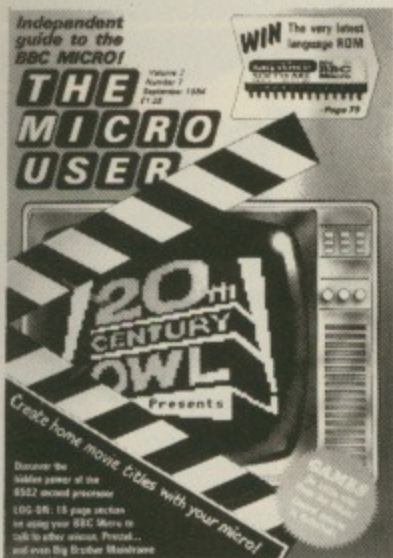

Vol. 2 No. 7 Sept 1984

Managing Editor
Derek Meakin

Features Editor
Mike Bibby

Associate Editor
Alan McLachlan

News Editor
Mike Cowley

Technical Editor
Mike Cook

Production Editor
Peter Glover

Layout Design
Heather Sheldrick

Advertisement Manager
John Riding

Advertising Sales
Mike Hayes

Marketing Manager
Susan Williams

Tel: 061-456 8383 (Editorial)
061-456 8500 (Advertising)
061-480 0171 (Subscriptions)

Telex: 667664 SHARETG
Prestel Mailbox: 614568383

Published by:
Database Publications Ltd,
Europa House, 68 Chester Road,
Hazel Grove, Stockport SK7 5NY.

Subscription rates for
12 issues, post free:

£15 - UK
£15 - Eire (IR £18)
£20 - Rest of world
(surface)
£65 - Rest of world
(airmail)

ABC Member of Audit
Bureau of Circulations

The Micro User welcomes program listings and articles for publication. Material should be typed or computer-printed, and preferably double-spaced. Program listings should be accompanied by cassette tape or disc. Please enclose a stamped, self-addressed envelope, otherwise the return of material cannot be guaranteed. Contributions accepted for publication will be on an all-rights basis.

© 1984 Database Publications Ltd. No material may be reproduced in whole or in part without written permission. While every care is taken, the publishers cannot be held legally responsible for any errors in articles, listings or advertisements.

The Micro User is an independent publication and neither the BBC nor Acorn Computers Ltd are responsible for any of the articles in this issue or for any of the opinions expressed.

News trade distribution:
Europress Sales and Distribution Limited,
11 Brighton Road, Crawley, West Sussex
RH10 6AF. Circulation 0293 27053.

CONTENTS

NEWS

23

Keep in touch with the latest happenings in the bustling world of the BBC Micro.

BEGINNERS

45

Save that precious memory and increase speed with fast and efficient integer variables.

TELETEXT TALES

50

We continue our easy-to-follow introduction to programming in teletext mode.

TELETEXT DUMP

56

Now you can dump Mode 7 text and graphics screens with this useful Epson utility.

SECOND PROCESSOR

63

We describe the hidden power of the 6502 second processor's extended instruction set.

CLASSROOM CORNER

71

An entertaining program using simple sums to test children on the four rules of number.

PROBLEM PAGE

75

Mike Cook explains the things you've always wanted to know but been afraid to ask.

COMPETITION

79

You could win one of the latest language ROMs for the BBC Micro in this month's contest.

ADVENTURES

81

Our forthright columnist takes her usual critical look at the world of adventures.



Binary Beacons

Communications is all the rage, but it's been going on longer than you think...

Page 106

Logging On

Have you logged onto Microweb yet? Our helpful article shows how simple it is to do.

Page 112

Microweb

This fascinating selection of messages shows why Microweb is a runaway success.

Page 114

Microterminal

Log on to Microweb with this superb terminal program. It's all done with interrupts.

Page 116

Big Brother

A cat can look at a king, and a modest micro can talk to a mainframe - we show you how.

Page 118

87 SOFTWARE SCENE

The latest software releases assessed by our team of frank and thorough reviewers.

98 VILLAINS

Can you preserve your Lithium crystals from the attacks of Hugo and his assassins?

102 VIDEO

Add that professional touch to your home video titles with our effective routines.

125 HARDWARE SCENE

We assess an interfacing package, an Eprom blower and compare two machine code monitors.

133 ROLLERBALL

A gentle yet compulsive simulation of a child's toy. Can you control the rolling spheres?

137 BODY BUILDING

Build a simple digital frequency meter and let your BBC Micro write your music for you.

164 SHOWTIME

We're moving back to Manchester for our fifth great show. And the walk-in forum returns!

177 MICROMAIL

The pages you write yourself. Just a small selection from the flood of letters pouring in.

193 ORDER FORM

From back issues to covers, cassettes to cases... everything you need is here.

SPECIAL OFFER!
Order both directly from us and deduct £1 from each.

TWO SENSATIONAL NEW RELEASES FROM SUPERIOR SOFTWARE

**BBC
MICRO**

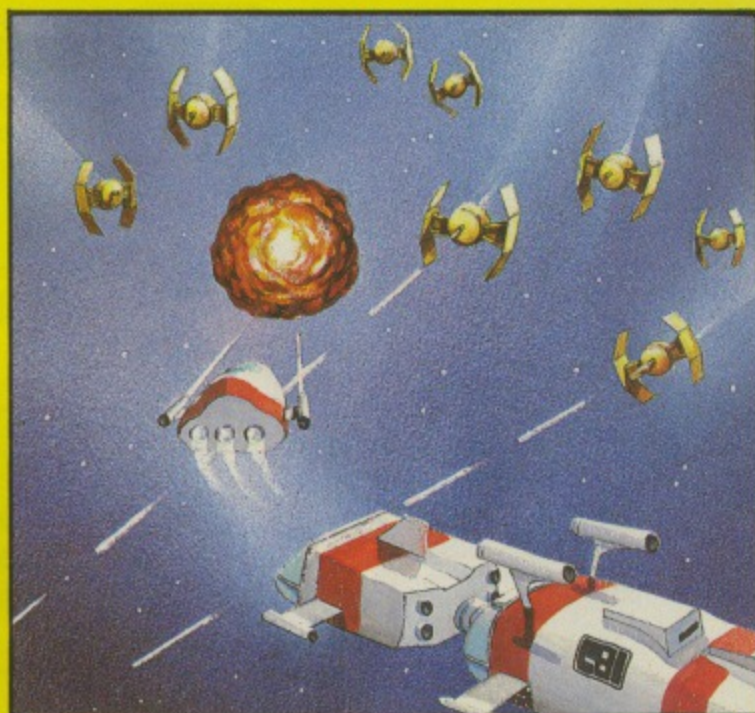

STAR STRIKER (32K)

£7.95

A multi-stage arcade-style game in which you take control of a 3-stage rocket equipped with 4 side lasers and a central laser cannon. Not only must you defend the rocket against the 6 types of circling alien, and avoid the asteroids and fireballs, but you must also attempt to dock the separate stages of the rocket together. Stunning graphics, sound effects, introductory tunes, hi-score and rankings. Another excellent program from Superior Software.
(KEYBOARD or JOYSTICKS)

OUR PROGRAMS ARE NOW AVAILABLE FROM OVER 1000 OUTLETS THROUGHOUT THE UK AND OVERSEAS. SEE YOUR LOCAL DEALER!

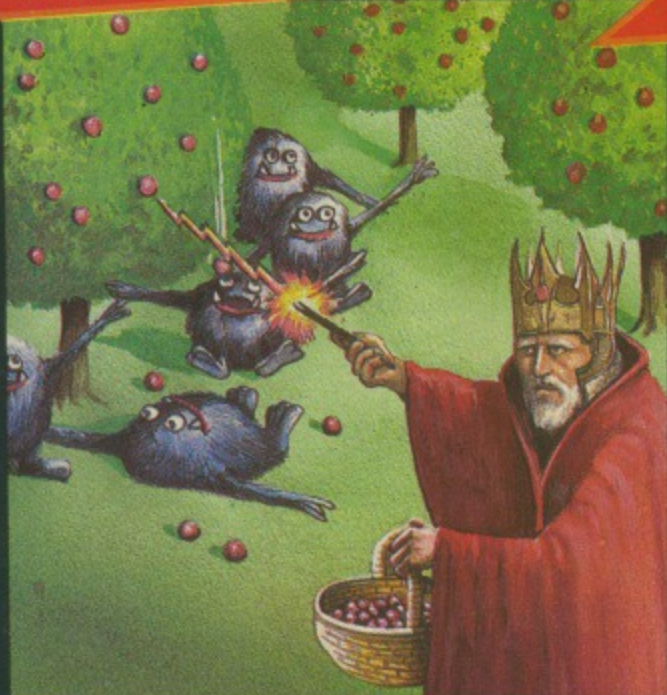

MR. WIZ (32K)

£7.95

From the author of Percy Penguin, Mr. Wiz is a fast-action multi-scene game. Guide Mr. Wiz around the garden to eat the cherries whilst avoiding the evil gremlins. The gremlins can be killed by dropping apples on them or by throwing the crystal ball. Extra points can be gained by eating the magic mushroom, but beware... this is the home of the gremlins and makes them permanently furious! Sound effects and tunes, hi-score, rankings. Superb arcade-style action.
(KEYBOARDS or JOYSTICKS).

WE PAY UP TO 20% ROYALTIES FOR HIGH QUALITY BBC MICRO AND ELECTRON PROGRAMS



SUPERIOR SOFTWARE LTD.

Dept. BM, Regent House,
Skinner Lane, Leeds 7
Tel: 0532 459453

OUR GUARANTEE

- (1) All our software is available before we advertise.
- (2) All our software is despatched within 48 hours by first-class post.
- (3) In the unlikely event that any of our software fails to load, return your cassette to us and we will immediately send a replacement.

Now there's a selection of hardware to match our selection of software.

At HMV we've just installed the latest ranges of hardware and peripherals alongside the massive selections of software in our Computer department. So whatever you need, whether it's a disk drive or a Hobbit, or simply some expert advice, you'll know exactly where to find us.

BBC Model B computer. Starter Pack including £80.00 of free software

BBC Model B computer. Starter Pack including £80.00 of free software	399.00	Frak (Aardvark)	8.90
BBC Model BD computer (including disk interface)	495.00	Gateway to Koros	9.95
DFS kit (including fitting)	99.00	Crazy Tracer	9.95
Torch Z80/cpm disk pack (including free software)	830.00	S-Pascal	16.80
Acorn 6502 second processor	199.00	Twin Kingdom Valley (Cassette)	9.50
Acorn Z80 second processor	299.00	Large range of Disk based software.	
Z80 Acorn CPM Software:		Complete range of Computer Concepts ROMS.	
Wordstar	395.00	Complete range of BBC Soft titles.	
Supercalc 2	195.00	Complete range of Program Power, Acorn, Lothlorian and Adventure International.	
Any CPM-80 software to order		Large range of Educational Software.	
Sir sideways ROM board (MkII)	45.00	Acorn Electron	199.00
Solidisk 32K sideways RAM	59.95	Acorn Plus One	59.95
Solidisk 128K extension for 32K board	99.95	Home Accounts, Mailist	each 19.95
Basic II upgrade	29.95	Forth	16.85
Microvitec 14" standard res colour monitor (TTL)	229.00	Creative Graphics, Tree of Knowledge	each 9.95
Microvitec 14" medium res colour monitor (TTL)	345.00	Chess (Acornsoft), Draughts and Reversi	each 9.95
Microvitec 14" standard res colour monitor (TTL/Comp/Audio)	255.00	Snooker (Visions)	8.95
Microvitec 14" medium res colour monitor (TTL/Comp/Audio)	390.00	Contract Bridge	7.95
Zenith 12" green monochrome monitor	95.00	Scott Adams Adventures 1-4	9.95
Zenith 12" amber monochrome monitor	95.00	Great Britain Limited	6.95
Acorn API00 printer	199.00	Alien Dropout, Bandits at Three O'Clock, Blogger	each 7.95
Memotech DMX80 printer (Dot Matrix F/T)	295.00	Chuckie Egg, Kamikazi	each 7.90
Epson FX/80 printer	410.00	Croaker, Escape from Moonbase Alpha, Eagles	each 7.95
Sanple Daisy Step 2000 (Qume compatible Daisy Wheel)	350.00	Felix in the Factory, Felix and the Fruit Monsters	each 7.95
Voltmace analogue joystick/handset	14.95	Lunar Rescue, Mined Out, Missile Control	each 7.95
Voltmace programmable joystick adaptor	13.95	Meteors, Snapper, Positron	each 9.95
Protek BBC/Atari joystick interface	11.95	Swoop, Daredevil Dennis	each 7.95
Datagem (Gemini database) (ROM)	129.00	Large range of Program Power and Acorn software.	
Ade (ROM)	60.00	Also: Memotech, Commodore, Sinclair, Hardware and Software, and a large range of books on various subjects.	
Spy 2 (ROM)	30.00		
Pascal (HCCS) (ROM)	67.00		
DFS Upgrade (Alligata) (ROM)	29.95		
Caretaker (ROM)	33.95		
Gemini business software (Disk or Cassette)	from 19.95		
Acorn business software (Disk)	each 24.95		
Aviator (Cassette)	14.95		
Aviator (Disk)	18.95		
JCB Digger (Cassette)	9.95		
JCB Digger (Disk)	11.90		
White Knight MkII (Cassette)	11.50		
Ghouls (Cassette), Jet Power Jack (Cassette)	each 7.95		
Scott Adams Adventures 1-4 (Cassette)	each 7.95		
Overdrive (Cassette), Battle Tank (Cassette)	each 7.95		
Kingdom of Hamil (Cassette)	9.95		
The Hobbit (Cassette)	14.95		

Ring 01-629 1240 to check for availability. All prices include VAT. Prices may change without notification.



The Computer Dept., 1st Floor, 363 Oxford Street. (Next to Bond St. Tube)

TORCH UNICORN

Designed with a total expansion capability

The Torch upgrade will give you a sophisticated business/professional system. However it doesn't stop there — it gives you the potential to expand — an expansion that no other current system can offer. Today, (not promises of 'one day!'), we are able to offer Hard Disc capability, networking of up to 254 machines, right up to the extra processing power of a 68000 32bit processor with 256K RAM, and optional UNIX operating system. **The potential is here!** The TORCHNET system, (software is included with all systems!), is a cost-effective method of linking office computing equipment in a simple and expandable fashion. TORCH means communication, whether it is inter-room communication, automatic 'home-to-office' communication, or electronic mail allowing a Torch user to initiate telex transfers, send tele-messages, use Electronic Mail (e.g. Telecom Gold), and talk to large mainframes. — **The potential is here!** Hardware is of no use without a suitable range of software, and the Torch can choose from a massive range of business, financial, application and language software. (Did you know that the Torch system has five times more software available for it than the IBM PC!) Why not contact us for your requirements?

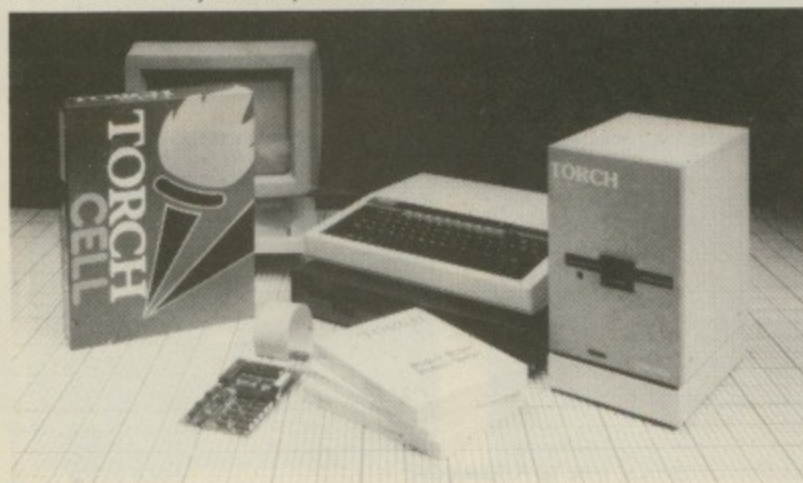

TORCH Z80 DISC PACK

The proven upgrade for the BBC Micro. Comprising 2 x 400K disc drive, Z80 processor with 64K of memory, and a CP/M compatible operating system. The system is supplied complete with the PERFECT software range including PERFECT WRITER, PERFECT SPELLER, PERFECT CALC, and PERFECT FILE. Full TORCHNET software is also supplied allowing sophisticated networking between other units and Z80 Basic. Disc Pack £699 (a).

GRADUATE

IBM PC Compatible Upgrade for BBC B
Ask for delivery date

The TORCH Z80 SECOND PROCESSOR CARD — for those who already have suitable disc drives. The card is supplied with all the free perfect software and Z80 basic, as detailed above, presenting a very attractive package. £299.

TELETEXT

Converts your BBC into a fully fledged Teletext Terminal. In addition to normal reception of Teletext pages, it is able to 'download' software as well as saving standard pages on any of the four TV channels. £196.

ULTRACALC

With advanced features, such as: *Handling of labels and numbers as values, allowing the search of a list by a meaningful name, instead of just a number. *Efficient memory usage allowing large spreadsheets to be constructed. *Variable width columns. Facilities include Sum, Replicate & most mathematical functions. It helps you to create and manipulate *Budgets *Cash-Flow forecasts *Price Lists *Balance Sheets *Time Sheets *Order Entry *Small Databases *Scientific Calculations etc. £69.00.

ACORN COMPUTER SYSTEMS

BBC Model B	£320.00a
BBC Model B + Econet	£389.00a
BBC Model B + DFS	£400.00a
BBC Model B + DFS + Econet	£450.00a
6502 2nd Processor	£175.00b
Acorn Z80 2nd Processor	£264.00a
BBC Teletext Receiver	£195.00a
BBC Dust Cover	£4.00d
Pair of Joysticks	£11.70c
Acorn Bit Stick	£3.28b

TORCH Z80 SYSTEM

TORCH Z80 Disc pack	£699.00a
TORCH Z80 2nd Processor Card	£299.00a
TORCH ZHD240 20Mb	£1995a

UPGRADE KITS

A to B Upgrade Kit	£75.00d
DFS Kit	£95.00 Installation £15.00
Econet Kit	£55.00 Installation £25.00
Speech Kit	£47.00 Installation £10.00

ECONET ACCESSORIES

Printer Server Rom	£41.00b
File Server level 1	£86.00b
File Server Level 2	£216.00b
Clock + 2 Terminators	£95.00b
Econet User Guide	£10.00d
10 Station Lead Set	£27.00d

BBC FIRMWARE

1.2 Operating System	£7.50d
Basic II Rom	£22.00d
View Word Processor Rom	£52.00c
Wordwise WIP Rom	£34.00c
BCPL ROM + Disc	£87.00b
Disc Doctor Utility Rom	£28.00d
Termi Emulator Rom	£28.00d
ULTRACALC Rom (BBC Publications)	£69.00c
GREMLIN debug rom	£28.00d
Computer Concepts Graphics Rom	£28.00d
EXMON	£20.00d
TOOL KIT	£20.00d
Printmaster Rom (FX80)	£28.00d
Communicator Rom	£59.00c
COMMSTAR	£29.00b

BBC ANCILLARY HARDWARE

EPROM Programmer	£89.00b
Smartmouth Speech Synthesiser	£37.00b
RH Light Pen	£39.50b
"Time-Warp" Real-Time	
Clock/Calendar	£29.00b
ACORN IEEE Interface ANKOI	£262.00c
Buzzbox Modem	£69.00b
Acorn Prestel Adaptor	£99.00b

PRINTERS & PLOTTERS

EPSON FX-80	£325.00a
EPSON FX-80 FT	£240.00a
EPSON FX-100	£480.00a
EPSON DX-100	£375.00a
Printer Share + Cable Set	£88.00c
JUKI 6 100 Daisy wheel	£350.00a
BROTHER HR15	£350.00a

Accessories:

Parallel or Serial Printer Lead	£8.00d
Serial Printer Lead	£8.00d
Epson Serial Interface 2K 8148	£50.00c
FX80 Dust Cover	£4.00d
Epson Paper Roll Holder	£17.00c
FX-80 Tractor Attachment	£37.00c
PAPER Fanfold 2000 sheets	£13.50b
Ribbon MX80/FX80/FX80	£6.50b
Ribbon MX/RX/FX100	£12.50c
Gemini Delta 10	£300.00a
Graphpad Graphics/Workstation	£120.00c
Graphics Plotter/Tablet	£490.00a
Basic Plotter	£270.00a
PSU12	£45.00 PSU24
PSU24	£79.00
Power Adaptor Cable	£4.50
Software on disc	£3.50
Driller Router	£79.00 Opto Sensor
Opto Sensor	£72.00

COLOUR/GREEN MONITORS (leads incld)

Microvitec 1431 14" RGB Std Res	£195.00a
Microvitec 1431 14" RGB/PAL + Sound	£225.00a
Microvitec 1451 14" RGB Med Res	£295.00a
Microvitec 1441 14" RGB Hi Res	£420.00a
Microvitec 2031 14" RGB Std Res	£287.00a
KAGA Vision II Hi Res	£260.00a
KAGA Vision III 12" RGB Super Hi Res	£358.00a
KAGA 12" Green Hi Res	£106.00a
SANYO DMB112CX 12" Green Hi Res	£99.00a
KAGA RGB Lead	£6.50d
BNC Green Screen Monitor Lead	£3.00d
Heavy duty monitor plinth for BBC	£13.50b
Two tier metal plinth	£19.50b
Microvitec plinth	£8.50b
Swivel base for Kaya Green	£19.50b

BBC COMPATIBLES 5.25" DISC DRIVES:

(All include cables, manual + format disc)	
100K (40 Track) Teac	£120.00a
100K (40 Track) with psu Tec	£135.00a
200K (40/80 Track) Teac	£155.00a
200K (80 Track) with psu Tec	£175.00a
400K (40/80 Track) Teac	£190.00a
400K (80TDS) with psu Mitsubishi	£200.00a
2 x 100K (40 Track) with psu Teac	£300.00a
2 x 200K (40/80 Track) with psu Teac	£390.00a
2 x 400 (80 Track DS) with psu 40/80	£420.00a
3" Hitachi 100K Drive	£150.00c

ALL PRICES EXCLUDE VAT. Please add carriage 50p unless

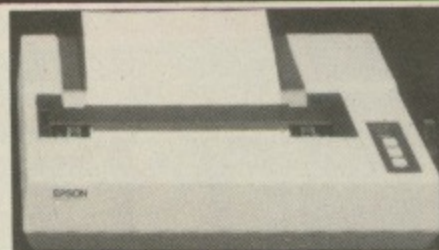

PRINTERS

We have a range of printers that will meet most requirements. **EPSON**—the high quality dot-matrix printers that set the standard in the industry— versatile printers that provide the optimum in performance & reliability. The RX80/FT provides all standard printing & graphic functions, (single sheets & perforated paper), with the de-luxe FX80 giving in addition proportional printing, italics, programmable characters etc. The FX100 also allows the use of 15" wide paper. Epson DX100—a new daisy wheel has the hallmark of Epson's quality performance and reliability. The **JUKI** and **BROTHER** daisywheels provide a quality normally found in printers costing far more. Printer cables, interfaces, ribbons, paper etc. are all normally available from stock.

GRAPHICS PLOTTER/WORKSTATION

Equally at home in the artists studio, hobbyists workshop, science laboratory, classroom, and production floor, this system has something to offer everyone. The 3-colour graphics plotter provides both precision and versatility. The carriage can be moved with an accuracy of 0.025 cm. over an A4 area — the plotter being able to accept paper and far thicker materials at sizes of up to A3. The basic colour plotter carries three colour pens each of which is software selectable. Various add-ons greatly increase the versatility of the unit, while still retaining the unit's accuracy. The servo controlled drill/router, and a scribe enables drilling, cutting and scribing in various materials. A unique Opto Sensor (using a Hewlett Packard Device) turns the plotter into a high resolution scanning digitiser to read and store whole diagrams, for example, for use in map work. This unique versatile Workstation is supplied complete at £490. Basic Plotter £270.

Our in depth stocks allow us to offer immediate deliveries on most items and our aim is to provide the best available products at competitive prices. In addition to the items listed above we carry extensive stocks of: connectors, connector assemblies, components including TTLs, CMOS, RAMS, EPROMs and CPUs. Spares for the BBC computers are normally available from stock. Orders from government departments, public bodies, hospitals, schools, colleges, universities and recognised PLCs welcome. We specialise in world wide exports. No VAT on exports. Our specially negotiated freight charges to many countries ensure the customer considerable savings on charges.

Everything you need for your BBC Computer

Plus friendly service and professional advice

£325.00a
£240.00a
£480.00a
£375.00a
£88.00c
£350.00a
£350.00a
£8.00d
£8.00d
£50.00c
£4.00d
£17.00c
£37.00c
£13.50b
£6.50c
£12.50c
£300.00a
£120.00c
£490.00a
£270.00a
£79.00
£4.50
£3.50
£72.00
£195.00a
£225.00a
£295.00a
£420.00a
£287.00a
£280.00a
£358.00a
£186.00a
£99.00a
£6.50d
£3.00d
£13.50b
£19.50b
£8.50b
£19.50b
£120.00a
£135.00a
£155.00a
£175.00a
£190.00a
£100.00a
£300.00a
£390.00a
£420.00a
£150.00c

Accessories:
Single Disc Cable £6.00d
Double Disc Cable £8.50d

3M DISCS with Lifetime Warranty
40T SS/DD Pkt of 10 £16.00c
40 DS/DD Pkt of 10 £22.00c
80T SS/DD Pkt of 10 £26.00c
80T DS/DD Pkt of 10 £30.00c
3" Double Sided Disc Each £4.50c
FLOPPICLENE Drive Head Cleaning Kit £14.50c
Disc Library Case £1.90d
Disc File Case 30/40 £8.00c
Disc Lockable Case 30/40 £15.00c
Disc Lockable Case 60/70 £27.00b

EPROMS:
2764-3 £6.50
27128-3 £21.00

SOFTWARE:
ACORN/MERLE BUSINESS SOFTWARE
Invoicing, Stock Control, Accounts Payable,
Accounts Receivable, Order Processing
Mailing System Each £22.65d
GEMINI Business-Full Range
ACORN/MSOFT-Full Range
ACORN LANGUAGES including BCL, LISP
S.Pascal Disc £17.30d
BCPL Calculations Disc £17.30d
FORTH with Manuals
BBCSOFT-Full Range
PROGRAM POWER-Full Range
BEEBUGSOFT-Full Range
Wordwise Spellcheck Disc £16.50d
Design £16.50d
Superplot £16.50d
Masterfile (Database) £16.50d
Teletext Pack (Mode 7 Graphics) £16.50d
Replica II £10.50d

CASSETTE RECORDERS:
SANYO DR 101 Data Recorder £30.00b
Datex Slim Line £20.00c
BBC Tape Recorder £28.50b
Cassette Lead £3.00d
Computer Grade C-12 cassette £0.45d
Computer Grade Cassette 10 off £4.00c
Phillips Mini-data cassette £3.00d

BOOKS (NO VAT) p&p £1.50/book
Let Your BBC Teach U to Program £3.50
BBC Micro Revealed £3.00
100 Programs for the BBC £6.95

30 Hour Basic £5.95
35 Educational Progs £6.95
6502 Applications £9.75
6502 Assembly Lang Programming £12.95
6502 M/Code for Beginners £5.95
6809 Assembly Lang Programming £13.95
Advanced Prog Tech for BBC £7.95
Advanced 6502 £10.25
Advanced User Guide £12.50
Assembly Lang Pro on the BBC £7.95
Assembly Lang for the BBC £7.95
Assembly Lang Prog for Electron £4.00
Assembly Lang Programming Birnbaum £8.95
Basic Prog on the BBC Cryer £5.95
BBC Basic £5.95
BBC Basic for Beginners £6.95
BBC Micro for Beginners £6.95
BBC Micro Disk Companion £6.95
BBC Micro Expert Guide £6.95
BBC Micro Graphics & Sound £6.95
BBC Micro in Education £6.50
BCPL User Manual £15.00
Beyond Basic £7.25
Creating Adventure Progs £6.95
Creative Graphics £7.50
DIY Robotics & Sensors £6.95
Discovering BBC M/Code £6.95
Forth £7.50
Friendly Computer Book £6.95
Graphics on the BBC Micro £6.95
Graphs & Charts £7.50
Interfacing the 6502 £10.95
Intro BBC Micro £5.95
LISP £7.50
Making Music on the BBC Computer £5.95
Micro Basic Sound Graphics £7.95
MOS Memory Data Book £3.95
Prog the BBC Micro £6.50
Programming the 6502 £9.95
Programming the 6809 £11.35
Programming the 8086/8088 £10.95
Programming the BBC £6.50
Programming the Z80 £9.95
Start Prog with Electron £5.00
Structured Programming £6.50
The Electron Book £7.95
TORCH Z80 Disc Pack User Guide £10.00
TTL Data Book Vol-1 £9.00
TTL Data Book Vol-2 £8.50
BBC User Guide £15.00
Using BBC Basic £10.00
Using Floppy Disks £6.95
Using the 6502 Assembly Lang £14.50
Z80 Applications Book £10.95

DISC DRIVES

A full range of disc drives fitted with quality Japanese slimline mechanisms, (such as TEAC, MITSUBISHI etc.) are supplied ready to connect to your BBC, and come complete with necessary cables, formatting disc, manual etc. TEAC & MITSUBISHI mechanisms can operate in single and double density modes. The switchable disc drives give the user flexibility, by allowing access to both 40 & 80 Track discs. We have a full range of diskettes, variety of disc storage cases, disc-drive cables. The Floppiclene head cleaning kit is the

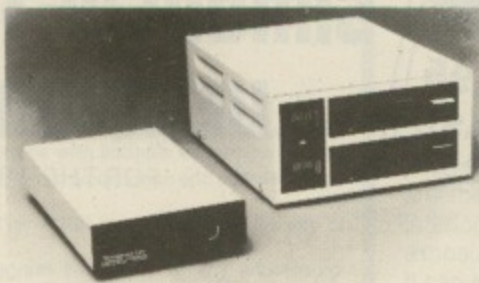

Switchable
400K and 800K
Drives now in stock

ideal way to ensure optimum performance of your drives. The use of disposable cleaning discs eliminate the risk of recontamination and abrasion, and ensure continuous data capture and transmission.

SCOTCH 3M FLOPPY DISCS

We now stock the high performance yet economical 3M range. Due to advanced production techniques, a higher standard has now been reached, enabling Scotch to guarantee error free performance for life.

NEW ACORN PRODUCTS:

We can now supply the following recently released ACORN products from stock.

Z80 Second Processor £264(a)

6502 Second Processor £175(b)

Bit Stick £328(b)

Prestel Adaptor £99(b)

ACORN IEEE INTERFACE

A full implementation of the IEEE-488 standard, providing computer control of compatible scientific & technical equipment, at a lower price than other systems. Typical applications are in experimental work in academic and industrial laboratories. The interface can support a network of up to 14 other compatible devices, and would typically link several items of test equipment allowing them to run with the optimum of efficiency. The IEEE Filing System ROM is supplied. £282.

VIDEO DIGITISER

Supplied complete with integral power supply, and ROM based software, it interfaces with the computer via the 1Mhz bus. A signal supplied from any standard video camera/recorder will provide a high quality picture, with eight different grey scale levels. The friendly yet sophisticated menu-driven software comes complete with an Epson printer dump. £218(a)

MONITORS:

MICROVITEC— a range of British Made DTI/ACORN Approved Std/Med/Hi-resolution RGB colour monitors that have a consistent, reliable performance. Also available in RGB/PAL/SOUND versions. The KAGA range provides a similar performance in 12" screen format. Our Japanese manufactured Hi-Res green screen SANYO is an ideal solution for high clarity 80 column text display. The KAGA green screen, with its 'chemically etched' anti-glare screen for the discerning user. All monitors are supplied with suitable leads at no extra charge.

GRAFPAD

A low cost graphic-tablet offering the performance and durability required for the business, industrial and educational user. It is small, accurate & reliable. Working area: 240 x 192mm + Menu area. CAD program £120(g).

Continued on page 11

TECHNOMATIC LTD.

All prices exclude carriage & VAT. Please add carriage as indicated and add 15% VAT to the total order value. For fast delivery telephone your order quoting VISA or Access card or official order number
Minimum telephone order (£5).

Carriage 50p

unless indicated as follows: (a) £8 (b)£2.50 (c)£1.50 (d)£1.00

PRINTMASTER ROM FOR THE FX80

This sophisticated printer handling ROM will support the Epson MX, RX and FX range of printers, and includes many useful features. You no longer need several printer ROMS as 'this one does it all!'. **PRINTMASTER** will dump in all modes. Three types of screen dumps are available, the most flexible being ***GDUMP** which operates in any graphics mode, displaying the colours as shades. Any part of the screen can be printed at any position on the paper in any one of the four orientations. The dump can be magnified by any factor x2, x3, x4 etc. A special feature allows true Mode 7 screen dumps with TELETEXT text and graphics, colours (as shades), double height etc. ***TDUMP** allows any text mode to be dumped and ***FDUMP** will print contents of a file on disc while the computer can be doing other things. The ***DEFINE** function allows the user to define his own characters and the facility to save them. Commands can be called from Basic programs and language ROMS. All for only £28 (c).

VIEW PRINTER DRIVER FOR EPSON FX80

This printer driver will enable the user to fully exploit the potential of the highly versatile Epson FX80 printer making text presentation both impressive and attractive.

A choice of 12 HT code options covering the full range of FX80's fonts is made available to the user. One of the options allows the user to call up the user defined characters stored in the printer buffer. However, the most powerful feature of the driver is its ability to offer the use of multiple HT codes in the same piece of text.

The booklet supplied with the driver includes illustrative examples and shows how to prepare and store formats for frequently used documents.
Supplied on disc £7.00(c)

MAIL ORDER TO: 17 Burnley Road, London NW10 1ED
(Tel: 01-208 1177 (4 lines))

SHOPS AT: NW London: 15 Burnley Road, London NW10 1ED
(Dollis Hill 2 mins walk, ample car parking space)

West London: 305 Edgware Road, London W2, Tel: 01-723 0233
(Near Edgware Road)

DO YOUR INVADERS FLY?

OR DON'T THEY EVEN GET OFF THE GROUND?

Bring your designs
to life with

SIMONSOFT SPRITES VERSION TWO

FOR THE BBC 32K

SAVE £4
NOW ONLY £8.95
WHILE STOCKS LAST

Transfer your ideas for multi-coloured characters directly to the computer and screen with the easy to use grid-based generator program. As you design the sprites they are automatically stored in our sprite routine which lies hidden under your program. The machine code sprite routine will move the shapes at incredible speeds of fourteen (14) times that of ordinary basic – and the routine is controlled with simple commands from your own Basic program!

Simonsoft sprites are used in programs on the market now. We claim no royalties on programs using our sprite routines.



OG THE CAVEMAN at £7.95 BBC 32K (£9.95 disc version).

Og is in a calamity. His territory has been taken over by dinosaurs that lay eggs at a really hectic rate. Og must crush the brood before they hatch by jumping on to each and every egg. Og's problems are compounded by a pack of slaving dinosaurs hungry for his blood – and on higher levels by grand old Ma dinosaur herself. Og can use his magic staff to set a trap, but time is precious as Og knows all too well. Big bonuses can be scored for jumping on fruit, and an even bigger bonus for snatching a kiss from his waiting cavewife.

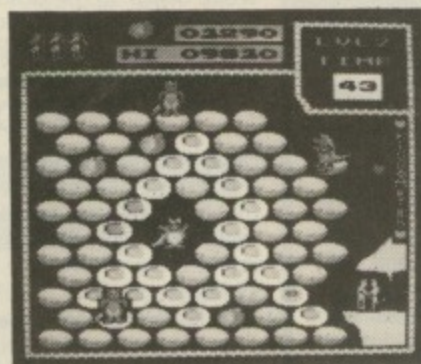

SCREEN PHOTOGRAPH

SUPERFRUIT at £5.95 for the BBC 32K (£7.95 disc version).

Features full colour hi-res graphics, great sound effects, spinning reels, 5 x 4 display of fruit, "bounce" as each reel settles, nudge box, nudge gambles, two-way nudges, swap reels, hold reels, collect win, gamble any win, "loser's gamble" if first gamble is lost, Supergamble for the jackpot and a coin pile that shrinks and grows with your winnings. Separate instruction program. This implementation is in a class of its own.

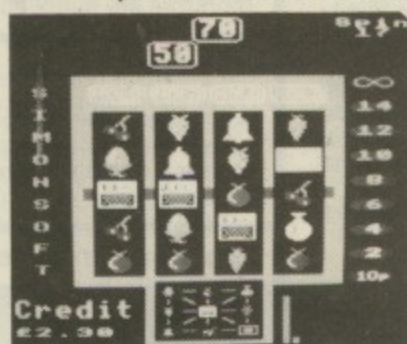

SCREEN PHOTOGRAPH

**A MUST for anyone who wants to see their
BBC's graphics stretched to the very limit.**

FEATURES:

- An ASTOUNDING FOURTEEN (14) FOLD INCREASE over the speed of ordinary Basic
- GENERATOR PROGRAMS with which you design MULTI-COLOURED SPRITE CHARACTERS
- SUPERSPRITES of up to 24 x 24 pixels
- 48 SPRITES made up of 12 separate designs each with 3 clones
- INSTANT ANIMATION with two images per sprite that switch automatically
- ENLARGEMENT FACILITY OF x2, x3, x4, x5 sprite size
- BUILT IN COLLISION DETECTOR
- FLIGHT PATHS that sprites can follow automatically
- SPRITE LIBRARY of ready to use character designs
- 30 PROGRAMS – choose the routine with the features best suited to your own program. Hidden under your Basic program the routine need take as little as 1.5K memory.
- SAVE/LOAD your program and sprites AS A WHOLE
- COMPREHENSIVE COLOUR MANUAL
- INTRODUCTION PROGRAM and DEMONSTRATION GAMES

Available at: £8.95 cassette, £8.95 cassette for transferral, £11.95 40/80 track disc to disc.

RETURN POST DELIVERY

Please rush one _____

_____ at £ _____

for the _____ computer.

Name _____

Address _____

Cut out this coupon and send it to:
**SIMONSOFT, 25 Tatham Road,
Abingdon, Oxon OX14 1QB
Telephone 0235 24140**

PROGRAMMERS: We pay lump sums and/or royalties of up to 30% for EXCELLENT PROGRAMS.

EPROMER II

Our current version of the highly popular Eprom programmer is now being enhanced to provide more and better facilities for easy programming by the user. The software will maintain its superiority over all currently available similar programmers. The range of eproms handled has been widened, to include

the eproms with lower programming voltage and eproms which can be programmed using the fast algorithm. Control of all operations has been moved to the keyboard. The screen display has been improved to give more information. The screen editing facilities have also been modified to simplify the data entry.

Preliminary Information

- The new Eprom Programmer will now program 2516, 2532, 2564, 2716, 2732, 2764, 27128 and 27256 + 5v eproms, and all but the 27256 in a single pass.
- The programmer will be supplied with integral power supply, and interfaces with the BBC via the 1MHz bus. It is fully buffered and complies with Acorn protocols. There is no power drain from the computer.
- No knobs or switches to fiddle with — total control from the keyboard
- Fully software driven with easy to understand instructions displayed on the screen.
- Eprom type selectable from the keyboard
- Selectable programming voltage 25/21/12.5V
- Defaults to normal programming with high speed algorithmic programming selectable, for a device with suitable capability.
- Continuous screen display of eprom type, option and address range selected.
- Full screen editor with HEX or ASCII input. Constant display of logical eprom address.
- Can read, blank check, program and verify at any address/addresses on the eprom.
- Full Tape/Disc filing facility.
- Several basic programs can be entered on a single eprom and called up with individual name.

EPROM ERASERS

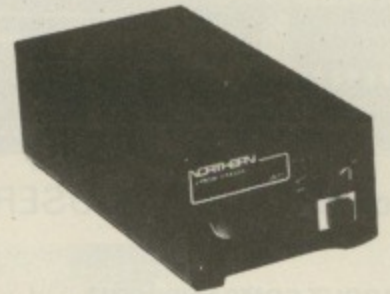

UV1T Eraser with built-in timer and mains indicator. Built-in safety interlock to avoid accidental exposure to the harmful UV rays. It can handle up to 5 eproms at a time with an average erasing time of about 20 mins. £59 + £2p&p.
UV1 as above but without the timer. £47 + £2p&p.

Now Available

GEMINI'S DATAGEM

The Definitive Random Access, 24K ROM based Database Management System

This is the first truly flexible database for the BBC micro which will have an application to offer in almost any field one can imagine.

*The file size is almost unlimited (Maxm. 10 Mbytes)

- *System will support up to 4 drives
- *Maxm. No. of records/file: 5000
- *Maxm. record size 6K
- *Maxm. No. of fields 62.

*9 level hierarchical search system with facilities to store results of searches. Searches can be any one of the following: Search, Include, Exclude, Combine, Common or Difference.
£112.00 + £2 carriage



'TIME-WARP' REAL-TIME-CLOCK/CALENDAR

A low cost unit that opens up the total range of Real-Time applications. With its full battery backup, possibilities include an Electronic Diary, continuous display of 'on-screen' time and date information automatic document dating, precise timing & control in scientific applications, recreational use in games etc — its uses are endless and are simply limited by one's imagination. Simply plugs into the user port — no specialist installation required — No ROMS. Supplied with extensive applications software. Please phone for details.
£29.00 + £2.50 carriage.

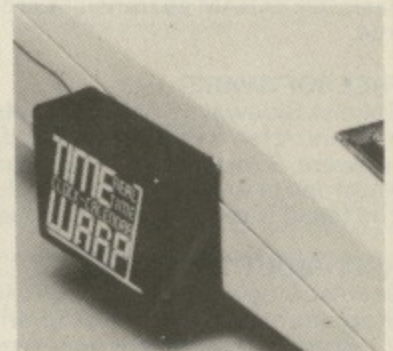

SMARTMOUTH

The original 'infinite speech'. Still the best.

A ready built totally self contained speech synthesiser unit, attractively packaged with built-in speaker, AUX output socket etc. — no installation

problems! It allows the creation of any English word, with both ease and simplicity, while, at the same time being economical in memory usage. You can easily add speech to most existing programs. Due to its remarkable infinite vocabulary, its uses spread throughout the whole spectrum of computer applications — these include industrial, commercial, educational, scientific, recreational etc. No specialist installation — simply plug into the user port — and SMARTMOUTH is supplied with demo and development programs on cassette, and full software instructions. £37 + £2.50 carriage.

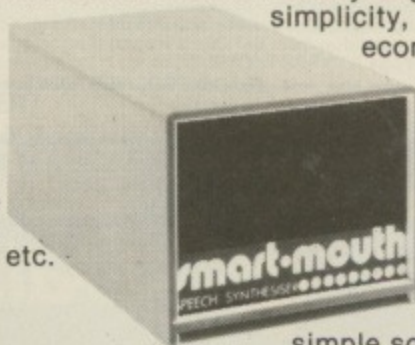

BUZZBOX

This is a full specification, direct connect modem, with both Originate and Answer modes, allowing access to the many databases, bulletin boards, as well as inter-computer communications. The modem conforms to the international CCITT V21 300/300 Baud standard. (NOTE: Not suitable for PRESTEL). Having full BT Approval, it connects directly to the telephone line, for optimum performance. Being battery powered, it is totally portable (optional power supply available). £69. BBC Lead £3.50. External PSU £8.00.

BEEBUGSOFT

A professional range of Firmware/Software to suit both the advanced programmer and the user. From the well known 'EXMON' and 'TOOLKIT' to the WORDWISE SPELLCHECK.

MORE FROM
TECHNOMATIC
ON PAGES...
8 & 9

MAIL ORDERS TO: 17 Burnley Road, London NW10 1ED
(Tel: 01-208 1177 (4 lines) Telex 922800)

SHOPS AT: NW London: 15 Burnley Road, London NW10 1ED
(Dollis Hill — 2 mins walk, ample car parking space)

West London: 305 Edgware Road, London W2. Tel: 01-723 0233
(Near Edgware Road)

TECHNOMATIC LTD.

All prices exclude carriage & VAT. Please add carriage as indicated and add 15% VAT to the total order value. For fast delivery telephone your order quoting VISA or Access card or official order number (Minimum telephone order £5).

SOLIDISK SIDEWAYS RAM: 8,000 UNITS SOLD

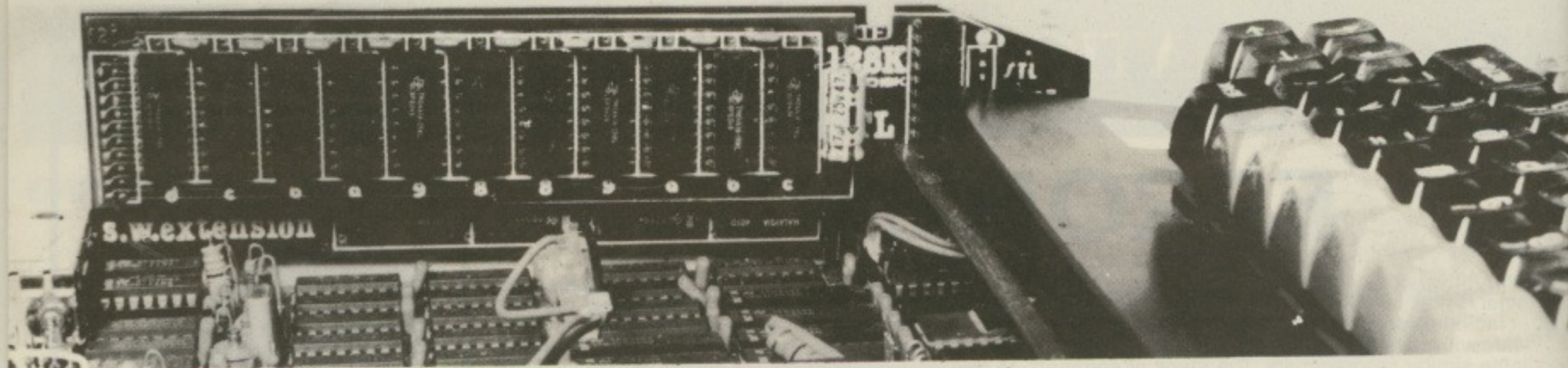

"Exciting" (ACORN USER JAN 84), "Power to your Beeb" (PCN 61, MAY 84)

HOW ABOUT COMPATIBILITY?

The Sideways RAM is completely compatible with all issues of BBC computers, disks, all sideways ROMs, second processor, Torch disk pack, Teletext, Econet etc. but NOT with ROM extension boards, since it can replace them.

Its power consumption is so low that you can use it in conjunction with twin disks.

HOW DOES IT WORK?

Occupying the same place as sideways ROMs (such as BASIC, DFS, CPN etc), it is treated like other Sideways ROMs and therefore can replace them.

The Machine Operating System uses Sideways RAMs as naturally as Basic, without procedures or programming rules.

Sideways RAM can run any language, any filing system including Hi-Basic and second processor DFS.

SIDEWAYS RAM POWER IS IN THE SOFTWARE:

Different from Sideways ROMs, Sideways RAM can be written into. This property gives birth to a NEW GENERATION of software for the BBC computer: SERVICE RAMs and VIRTUAL MEMORY PROCESSOR.

Each SERVICE RAM has its own commands and code as its counterpart Sideways ROM but has its own private workspace and storage area thus leaving you with the lowest possible PAGE value (PAGE=&E00). On the other hand, the Virtual Memory Processor can run huge MACRO BASIC programs (Megabytes are not the limit), keep them on disk and uses the basic 32k of RAM as transient program area. All software for the Sideways RAM system is free.

FREE SOFTWARE?

Solidisk Sideways RAMs is bundled with lots and lots of software, FREE and we mean FREE, now and later. It is quite simple: for every Sideways RAM sold, £1 is spent on MORE software. Sideways RAM users are invited to spot new applications and contributions are rewarded at the usual rate of £1 for every 4 bytes of machine code. The result is printed on the opposite page.

HOW ABOUT THE FUTURE?

Solidisk Sideways RAM is also widely used in schools for ECONET stations, by professional programmers for writing programs, research laboratories for RAM disk data base, at home for wordprocessing and now even games.

New areas are being developed: Telesoft and Teletext logging, Speech Processor assembler and Relational Data base to cite a few.

As the price of 16k EPROMs are as high as £20 at the present time, more Sideways ROM software publishers will be willing to sell their software on disk. Solidisk will mail FREE OF ANY COST their advertisement to ALL Sideways RAM users providing the price of the Disk version reflects savings in the cost of the ROMs. Solidisk believes that the majority of BBC users will have their Sideways RAM fitted before the end of next year.

Also unlike other makes (SIR, APTL, WE Sideways ROM/RAM extension boards and the Aries B20), Solidisk Sideways RAM is expandable from 16k right to 128k and now to 208K. As a result of VLSI technology and volume of sales, Solidisk products also have a lower shop price than any other products.

OTHER PRODUCTS FROM SOLIDISK:

UVIPAC EPROM ERASER:

Uvipac is powered by the mains, simple to operate and can erase 3 Eproms of any type in just 15 minutes. Uvipac is ideal for home use.

DETACHABLE KEYBOARD CASE:

Remove the keyboard from the BBC computer and instal it in the new case. Replace the old 3" keyboard tail by the new 24" cable and you can work really in comfort even for very long hours. The keyboard case is more a productivity tool than just ergonomics.

CPU CASE:

Replace the top of the BBC computer case by this metal CPU case. Sit your monitor on top (it is tough enough to take even your weight!). The CPU case has 2 compartments for half height 5.25" disk drives with fixing screws, air vents and provision for a bolt-on fan. At first sight, there is no trailing wire. Looking inside, there is enough room to accomodate Teletext Adapter, Second Processor, Solidisk and a fan!

DOUBLE DENSITY DISK INTERFACE:

2 versions of this double density interface will be available: as direct replacement for the Acorn Disk Interface (Version A) and as a Second Disk Interface (Version B) adding to your existing interface. They all use the same Western Digital controller chip (WD1770). Price £39.95 inclusive

DISK DRIVES:

3 models are being offered:

STL55A: 40 tracks single sided, SLT55F: 2 x 80 tracks, double sided and the best of mini floppy technology STL320: 2 x 160 tracks, double sided.

All disk drives are supplied with cables, formatter disk, head cleaning kit and 2 year warranty.

"Break the Ram Barrier" (A&B)

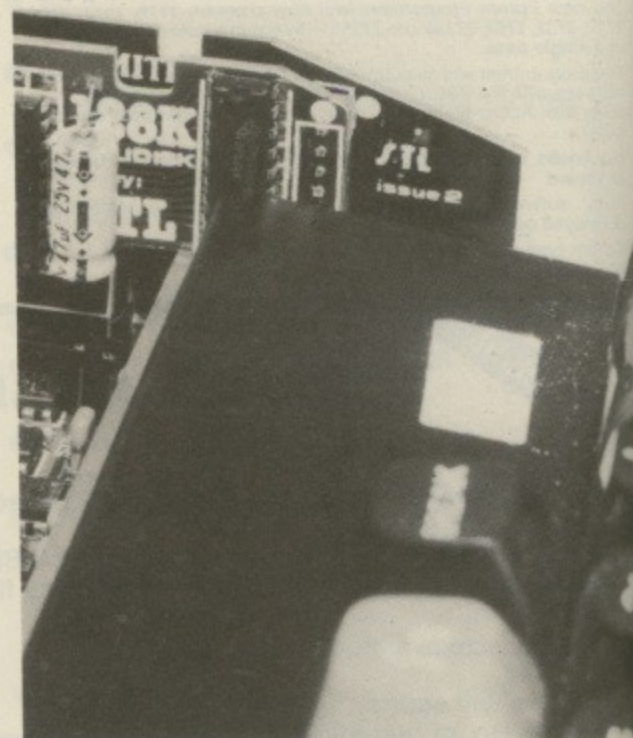

UVIPAC EPROM ERASER

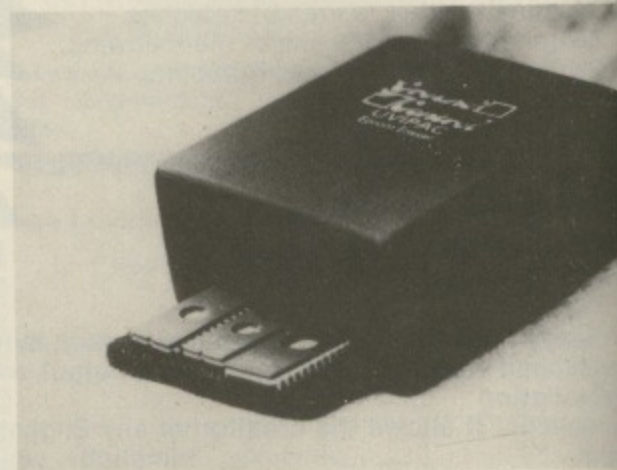

TEAC DISC DRIVES FD55 Series



WHI

Solidisk (SWR32) and the now an SWR32 exchange

FREE S WORDS WORD character

SILEXIC SILEXIC a minute words

PRINTE PRINTE to 15K long do

STLEO STLOC format

STL15 STL15 side.

STL-R STL-R applica onto E socket disks,

INDEX INDEX such a gives i number

MACR MACR which files (a which

VIRTU VIRTU back s RAM a taking from t assem

MENU MENU Firma

MORE While with a sidev. Each warrar Serv *It shou softwa the mos sided). For the SILEXIC German Every u

HOW You c Acces Educ

Name Addr

Credi

Callo

If ord once

SOL 17 SW SOU ESS

HIGH SIDEWAYS RAM DO YOU NEED?

Disk Sideways RAM is available in 16k (SWR16), equivalent to 1 sideways ROM, 32k (SWR32), equivalent to 2 sideways ROMs, 128k (Solidisk), equivalent to 8 sideways ROMs and the 208k Solidisk equivalent to 12 Sideways ROMs. You can buy a small Sideways RAM and upgrade it later. From the SWR16 to the SWR32 is by straight exchange, from the SWR32 to the Solidisk is by adding the 96k Solidisk Extension, from 128k to 208k is by changing the RAM card.

THE SOLIDISK SOFTWARE:

WORD64:

WORD 64 is a Service RAM, it uses Solidisk as storage for WORDWISE, up to 64K free characters for any text.

SILEXICON:

SILEXICON is a Spelling Checker for Solidisk. SILEX scans texts at more than a 1,000 words per minute and compares each word against the dictionary, Silexicon marks the mis-spelled words for either addition to the dictionary or eventual correction.

PRINTER BUFFER:

PRINTER BUFFER is a Service RAM, it increases 500 times the normal 32 bytes printer queue to 15K bytes, completely transparent to the user. PRINTER BUFFER is as useful for printing a long document as for a short program listing.

FILEEEO:

FILEEEO is a Service RAM, it is Disk Filing System that leaves PAGE at &EEO, has built-in disk formatter/verifier and automatic track stepping for 40/80 track disk drives.

FILE150:

FILE150 is a Service RAM to enhance Acorn's .90 DFS to offer up to 150 directory entries per directory.

FILE-RFS:

FILE-RFS (RAM/ROM filing system) is a Service RAM and an innovation in portable applications. STL RFS saves any program in a Sideways ROM format, it can then be copied into EPROM to give instant recall of your programs. Plug this EPROM into any sideways socket, type *RFS and it runs itself. Compatible with the ELECTRON and BBC, tape and disk, SWR16, SWR32 and Solidisk.

INDEX:

INDEX is a Service RAM, it stores all the entry points of one or several sequential data files such as mailing list, stock list, accounts etc, merges, sorts them in alphabetical order and gives instant access to any record. INDEX can handle 1,100 records of any size, any type, any number of fields.

MACRO-BASIC:

MACRO-BASIC is a program generator. You use a wordprocessor to create a command file which is then scanned by MACRO. MACRO uses other programs, subroutine libraries, text files (actually any or all files on your disks) as source to generate a bug free BASIC program which can be very large (Megabytes are not the limit).

VIRTUAL MEMORY PROCESSOR:

VIRTUAL MEMORY PROCESSOR (VMP) uses extensively overlay technique and Solidisk as back store for very large programs that cannot be run otherwise. VMP uses the 32k basic RAM as transient area: it operates on a Main Program as generated by MACRO-BASIC, taking different segments from the Solidisk Store, POOL, HOLD, FREE or CLEAR segments from the transient area. For example: VMP will accept 20 segments of 10k of Basic assembler and assembles it into 16k of machine code.

MENU:

MENU puts all computer's resources at your fingertips. MENU displays your Sideways Firmware, Disk Directories, Sideways RAM system, Solidisk System etc.

MORE FREE SIDEWAYS RAM SOFTWARE TO COME:

While others are making promises for software to be written, Solidisk Systems RAM comes with a complete, novel and powerful software package including compatibility with existing sideways software.

Each Sideways RAM is accompanied by the Sideways RAM User Manual, full 1 year warranty, 1 utility disc* and free mailing on all new publications from the Software Support Service.

*It should be understood that we cannot put as much free software on a 40 track single sided as on a 80 tracks. The present software package require 160 tracks of storage and can be accommodated on ONE 2 X 80 track double sided diskette, only the most useful programs are supplied on other formats (ie 40 track single sided, 2 X 40 track double sided, 80 track single sided). Should you require the whole collection of free software, please place an order for extra disks.

For the technical minded: the Source Code and Technical Manual (3 floppies and a 300+ page book) price = £10, the SILEXICON EXTENSION PACKAGE (3 floppies and a 40 page manual, 30,000 word dictionary: English and French now, German and Spanish planned) price = £9.00. '4S' also publishes regular updated SWR utility discs at £3.00. Every user can do contract work for the SUPPORT SERVICE and make a lot of money for him/herself!

HOW TO ORDER?

You can order any item using the coupon. Post and packing is only charged once. Access and Barclay card holders can place their order by phone. Educational authorities, Acorn dealers and OEMs can obtain quantity discounts.

Name: _____
Address: _____

Credit Card Account: _____

Callers are requested to ring first for appointment.

Total: £ _____
If ordering more than one item, deduct £1 per item as post and packing cost is only charged once.

SOLIDISK TECHNOLOGY LIMITED
17 SWEYNE AVE
SOUTHEND-ON-SEA
ESSEX SS2 6JQ

SOLIDISK'S NEW TELEPHONE NUMBER:
SOUTHEND-ON-SEA (0702) 354674
(10 lines with automatic exchange)

HOW EASY TO INSTALL:

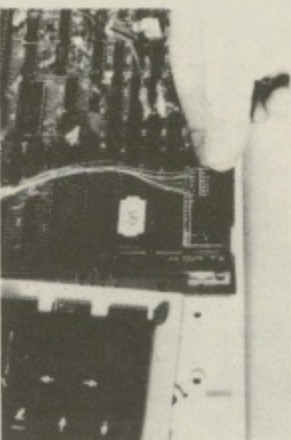

Push in the base unit

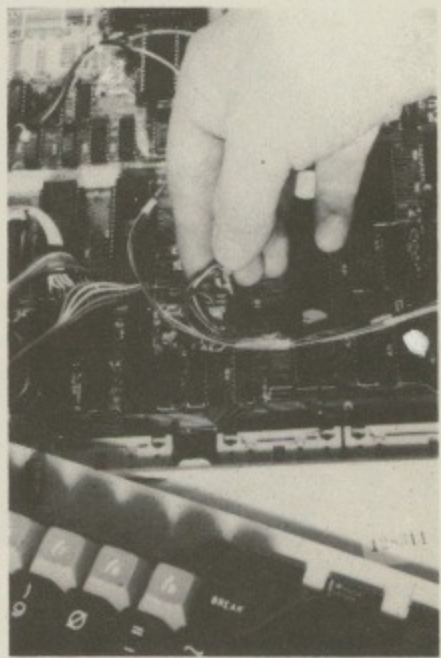

Connect the control wires

PRICE LIST (including VAT and post & packing)

SIDEWAYS RAM:	
SWR 16K	£43.65
SWR 32K	£59.95
128K SOLIDISK	£150.95
208K SOLIDISK	£243.00
The following are upgrade prices for existing Sideways Ram owners:	
16 - 32 (please return complete item)	£18.00
16 - SOLIDISK (please return complete item)	£109.00
32 - SOLIDISK (no return necessary)	£93.00
128K - 208K SOLIDISK	£93.00
DISK DRIVES:	
STL55A (40 track, single sided, cased with cables, diskette, manual and 2 years warranty)	£142.95
STL55F (2 X 80 track, double sided, as above)	£232.95
STL320 (2 X 160 tracks, double sided, as above)	£499.00
FLOPPY DISKS (DATALIFE Verbatim):	
MD525 (SS/DD 40 or 80 track) box of 10	£16.00
MD550 (DS/DD 40 or 80 track) box of 10	£22.00
MD557 (DS/DD 98 TPI) box of 10	£27.00
CPU CASE	£13.00
DETACHABLE KEYBOARD CASE	£27.99
EPROM PROGRAMMER (used with Sideways Ram)	£16.00
UVIPAC EPROM ERASER (free standing unit)	£20.95
2764 PACK OF 5	£36.00
SOURCE CODE + TECHNICAL MANUAL	£10.00
SILEXICON EXTENSION PACKAGE	£9.00

WE STOCK A LARGE RANGE OF PRINTERS AND MONITORS. CALL OUR SALES OFFICE FOR IMMEDIATE QUOTATION.

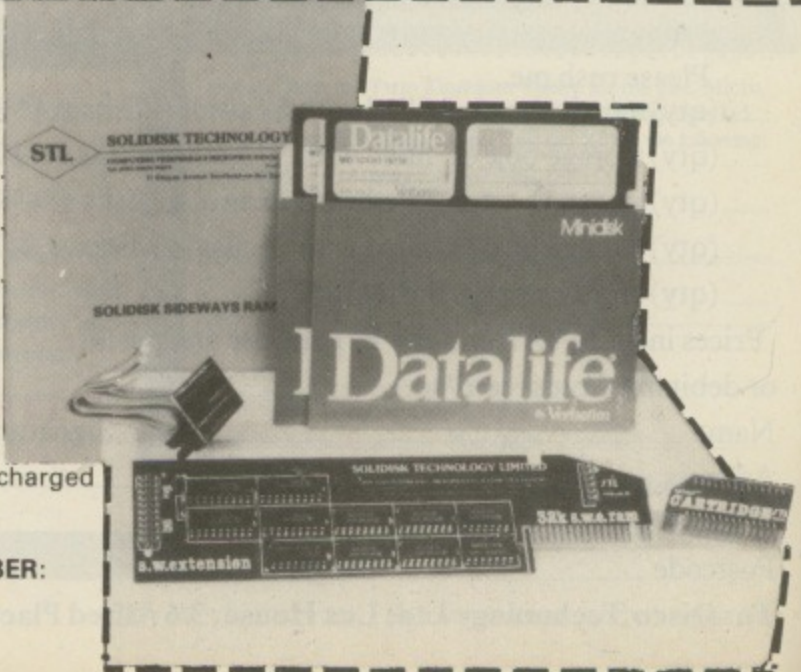

Half a box is better than one?

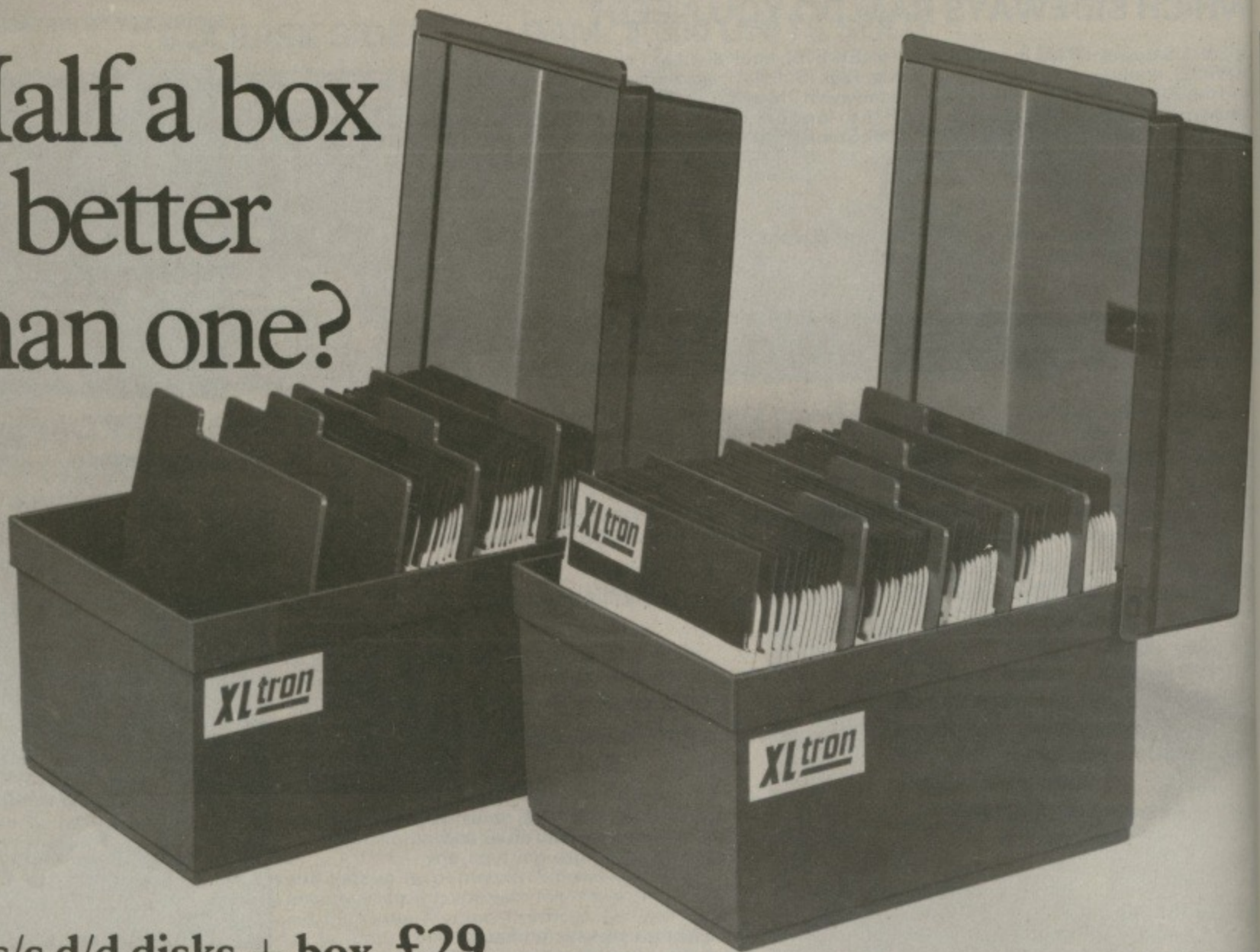

25 s/s d/d disks + box £29
plus VAT and P + P
25 d/s d/d disks + box £39
plus VAT and P + P

50 s/s d/d disks + box £50
plus VAT and P + P
50 d/s d/d disks + box £75
plus VAT and P + P

We ran the advertisement opposite to move some stock left from a cancelled order. And move them it certainly did. We're still selling around 30 boxes a day, that's over 30,000 disks a month. So we bought some more, and are going to continue selling at the same price.

We also got a lot of people on the phone asking if we could supply slightly fewer disks, and as you see, we're now offering boxes in 25's as well.

Every order of 25 or 50 comes packed in the same rigid plastic storage box with four dividers, we've kept the same high specification and all disks carry our two for one guarantee.

To order, just clip the coupon below. Personal callers welcome.

We accept orders from all government bodies, schools, universities, libraries, armed forces etc. We despatch on receipt of an official purchase order. If you can't raise a cheque without an invoice please post or telephone your order and we'll send you a proforma by return.

Disco Technology Limited, Lex House, 3/6 Alfred Place,
London WC1, England. Telephone 01-631 0255,

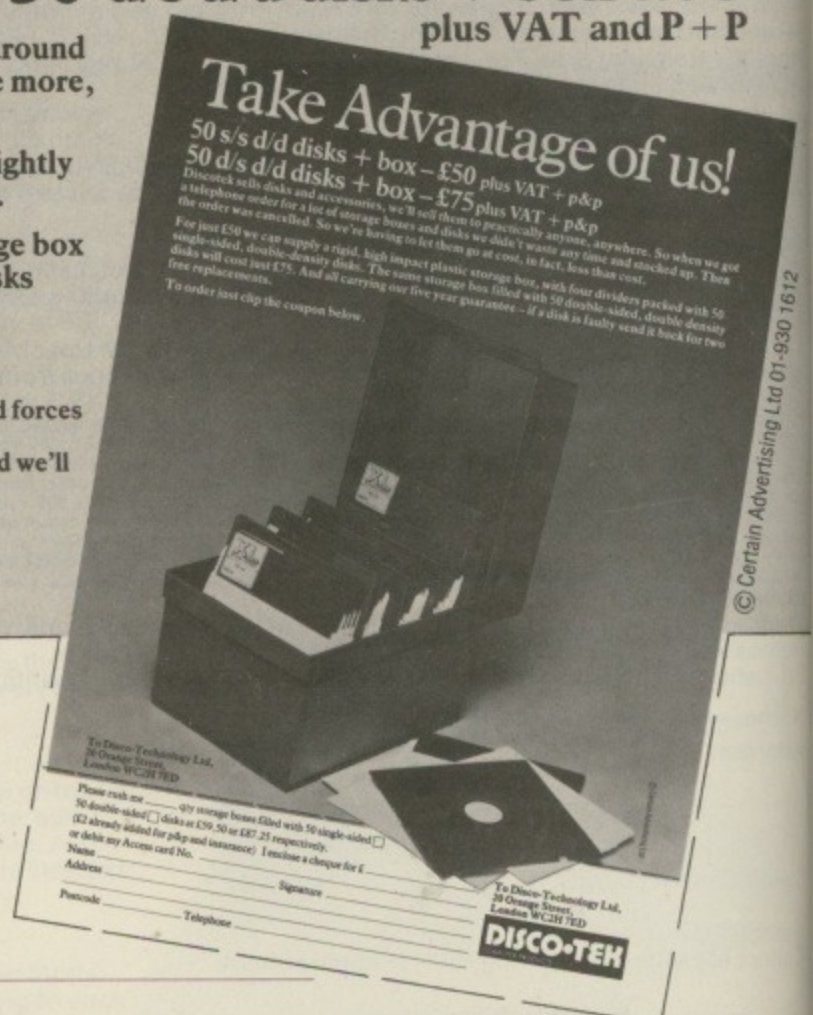

- Please rush me
- ___ (qty) storage box(es) filled with 50 s/sided disks at £59.50 each.
 - ___ (qty) storage box(es) filled with 50 d/sided disks at £87.25 each.
 - ___ (qty) storage box(es) filled with 25 s/sided disks at £33.65 each.
 - ___ (qty) storage box(es) filled with 25 d/sided disks at £47.15 each.
 - ___ (qty) empty storage box(es) at £11.

Prices include VAT and P + P. I enclose cheque for _____
or debit my Access card no. _____

Name _____ Signature _____

Address _____

Postcode _____ Telephone _____

To: Disco Technology Ltd, Lex House, 3/6 Alfred Place, London WC1.



MU/9

© Certain Advertising Ltd 01-930 1612

ATTENTION ALL BBC MICRO USERS!

Special Offer
exclusive to
Micro User
readers!

3 fantastic games for the price of one!

When you order your copy of our best selling adventure game "TWIN KINGDOM VALLEY" we will send you a choice of two other games for your BBC, FREE. A breakthrough in adventure programs, Twin Kingdom Valley will take you on an incredible journey through over 175 full colour, graphic locations to test your ingenuity to the limit.



£9.50
+ 75p p&p

Choose any 2 for Free!

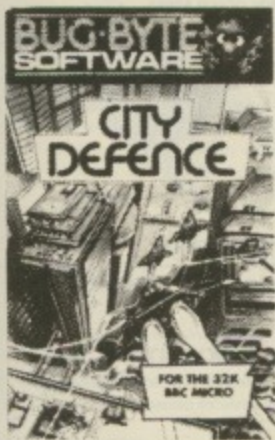

City Defence

Save your cities from wave after wave of missile attacks.

RRP £7.50



Galaxy Wars

Feel the adrenalin flow as a simple mission turns sour.

RRP £7.50



Old Father Time

Pit your wits against this traditional style text adventure ... mind blowing!

RRP £9.50



Sea Lord

Things get rough when your mini-sub strays into the domain of a crazed dictator.

RRP £7.50



Oblivion

One of the all time classic alien shoot-em-up games.

RRP £7.50

Please rush me Twin Kingdom Valley for the BBC Micro. I enclose Cheque/P.O. for £10.25 payable to Bug-Byte Ltd. I claim my 2 FREE BBC games. Tick any 2 from the following:

City Defence Galaxy Wars Sea Lord
Oblivion Old Father Time

Name

Address

Post Code

Mail to: Bug-Byte, TKV Special Offer, Mulberry House, Canning Place, Liverpool. Allow 14 days for delivery. M.U.9

Offers available while stocks last.

DISKING NEWS

We ship the worlds' best diskettes FASTER than anybody. We ALWAYS enclose a VAT invoice and current price list. It's not "Yes sir we're expecting delivery in 4-6 weeks" or "Please allow 28 days for delivery" - What rubbish we put up with in the U.K.?! Just ring another company in this magazine - we did. We purchased a modem advertised on another page - two months later we've still no modem OR explanation, AND we can't leave a message they've no answering machine! EVERYTHING you see in this ad. is ON THE SHELF NOW. We despatch within FOUR working hours or we'll ship FREE!! Write or call (24 hrs) for our general price list. Coming soon:- The new Microdisk SEE 10 library box PLUS Disking Business Diskettes - They'll blow your mind.

FREE with EVERY ten-pack of diskettes from DISKING SEE 10 LIBRARY BOX

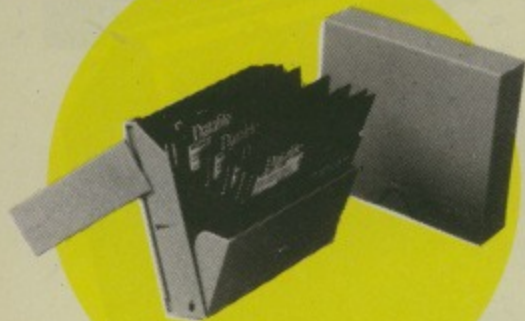

The award winning device for storing and displaying ten diskettes. Available individually at £2.50 exc. VAT see under 'Diskette Storage'.

PLUS DISKING COLOUR CODERS



A multicoloured pack of ten fibre tipped pens for colour coding your diskette labels available individually at 49p per pack of ten exc. VAT.

DISKING SUPER PROMOTION FREE CLOCK VALUE £8.95



With every TWO Ten-Packs* of ANY 3 1/2", 5 1/4" or 8" disks by Verbatim, Memorex, Dyan or Maxell purchased at these prices, we will pack a Super Disking Calendar Clock worth £8.95 absolutely FREE.

Order four Ten-Packs, and you will receive two Calendar Clocks and so on.

*Excluding diskettes purchased from bargain corner. All FREE offers are subject to availability.

MEMOREX



MEMORY EXCELLENCE

Memorex diskettes are everyone's favourite, and work well in ALL computer systems.

5 1/4 INCH DISKETTES

Certified for single OR double density and with hub ring reinforcement.

PRICES EXC VAT	10-40	50-90	100+
3481 S/S 48 tpi	21.90	20.90	19.90
3491 D/S 48 tpi	27.90	26.90	25.90
3504 S/S 96 tpi	27.90	26.90	25.90
3501 D/S 96 tpi	35.90	34.90	33.90

48 tpi suitable for 35 or 40 track operation
96 tpi suitable for 77 or 80 track operation
10 and 16 Hard Sector available at same prices

MEMOREX 3 1/2" MICRODISKS - HERE AT LAST!

PRICES EXC VAT	10-40	50-90	100+
6100 S/Sided	42.90	41.90	40.90

0.5M Byte rating auto shutter
3 1/2" library boxes coming soon

FREE



To celebrate three successful years with Memorex we are giving away a Memorex C-90 cassette tape with every ten-pack of Memorex floppies. This offer does not affect any of our other promotions, and is in addition to them.

DISKING

DISKING Means Business

NEW DISKING SWING LID BOX for 60 minidisks, comes with keys, dividers, tags and even built in carrying handles. At our price the best value around - Recommended Price £22.50.



D.S.L.B. - £17.90
buy 3 and get fourth one free. Post & Packing at 4 unit rate.

DISKETTE STORAGE



ABA lockable diskette storage comes in two sizes each for the mini disks and 8" disks. They hold either 40 or 80 diskettes.

M35 - 40 mini disk capacity £14.90
M85 - 80 mini disk capacity £18.90
F40 - 40 8" diskette capacity £18.90

SEE 10 LIBRARY BOX Free with every pack of ten diskettes this superb storage device keeps dust out, yet enables instant selection.



Part No.	Description	Price
SEE 10	Library Box	2.50
LB8	Library Box (not SEE 10 design)	3.00

DISKETTE ACCESSORIES

'PERFECT DATA' CLEANING KIT

The one that really works well in ALL drives - get it now before the gremlins strike.



Part No	Description	Price
CK5	For 5 1/4" disk drives	14.90

5 1/4" DISKING SUPERMAILERS

Very rigid copyright design, takes up to 4 disks.

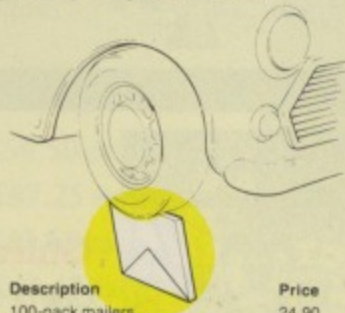

Part No	Description	Price
DSM	100-pack mailers	24.90

DISKING DISKWRITERS

Packed in 25's and sold in 50's, these superb blue or black pens are 100% safe for use on diskette labels. Please state ink colour when ordering.

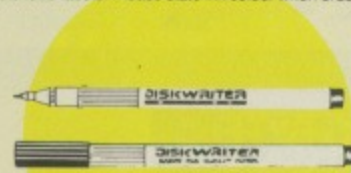

Part No	Description	Price
DW	50-pack Diskwriters	9.90

U.K. SHIPPING RATES INC. INS. BUT EXC VAT

5 1/4" or 3 1/2" DISKETTES
1-2 packs each pack at 95p
3-5 packs each pack at 75p
6-9 packs each pack at 60p
10+ packs POST FREE

5 1/4" CLEANING KITS
same as 5 1/4" diskettes

5 1/4" SEE 10 LIBRARY BOXES
1-4 off at 40p each
5-9 off at 30p each
10+ off at 20p each

8" DISKETTES
1-2 packs each pack at 1.60
3-5 packs each pack at 1.20
6-9 packs each pack at 90p
10+ packs POST FREE

8" CLEANING KITS
same as 8" diskettes

8" LIBRARY BOXES
1-4 off at 60p each
5-9 off at 45p each
10+ off at 30p each

DISKING SUPERMAILERS
100-pack 3.00

LOCKABLE STORAGE (all versions)
1 off 2.00 each
2-7 off 1.30 each
8+ off POST FREE

DISKING COLOUR CODERS
25p each - 5+ POST FREE

DISKING DISKWRITERS
50-pack 1.00

Dysan



DYSAN - FOR THE DISCERNING

With new lower prices, Dysan's impeccable reputation is now a genuine bargain.

5 1/4 INCH DISKETTES

Certified for Single OR Double Density. 48 tpi with Hub Ring reinforcement.

PRICES EXC VAT	10-40	50-90	100+
04/1D S/S 48 tpi	23.90	22.90	21.90
04/2D D/S 48 tpi	34.90	33.90	32.90
04/1D S/S 96 tpi	34.90	33.90	32.90
04/2D D/S 96 tpi	42.90	41.90	40.90

8 tpi suitable for 35 or 40 track operation
6 tpi suitable for 77 or 80 track operation
0 and 16 Hard Sector available at same prices.

8 INCH DISKETTES

PRICES EXC VAT	10-40	50-90	100+
740/1D S/S D/Dens	32.90	31.90	30.90
740/2D D/S D/Dens	40.90	39.90	38.90

2 Hard Sector available at same prices

maxell



MAXELL - THE GOLD STANDARD

Maxell's very high quality control ensures all standards are met and surpassed.

5 1/4 INCH DISKETTES

Certified for Single OR Double Density. All with Hub Ring reinforcement

PRICES EXC VAT	10-40	50-90	100+
MD1-D S/S 48 tpi	24.90	23.90	22.90
MD2-D D/S 48 tpi	32.90	31.90	30.90
MD1-DD S/S 96 tpi	32.90	31.90	30.90
MD2-DD D/S 96 tpi	42.90	41.90	40.90
MD2-HD D/S 1.6MByte	59.00	56.00	53.00

48 tpi suitable for 35 or 40 track operation
96 tpi suitable for 77 or 80 track operation

8 INCH DISKETTES

PRICES EXC VAT	10-40	50-90	100+
FD1-12B S/S S/Dens	29.90	28.90	27.90
FD1-1XD S/S D/Dens	34.90	33.90	32.90
FD2-XDD D/S D/Dens	39.90	38.90	37.90

Verbatim



DATALIFE - FIVE YEAR WARRANTY

The world market leaders, with perfect data retention time after time - for a lifetime.

5 1/4 INCH DISKETTES

Certified for single OR double density and with hub ring reinforcement.

PRICES EXC VAT	10-40	50-90	100+
MD525 S/S 48 tpi	22.90	21.90	20.90
MD550 D/S 48 tpi	29.90	28.90	27.90
MD577 S/S 96 tpi	28.90	27.90	26.90
MD557 D/S 96 tpi	36.90	35.90	34.90

48 tpi suitable for 35 or 40 track operation
96 tpi suitable for 77 or 80 track operation
10 & 16 Hard Sector available at same prices

8 INCH DISKETTES

PRICES EXC VAT	10-40	50-90	100+
FD34-9000 S/S S/Dens	31.90	30.90	29.90
FD34-8000 S/S D/Dens	31.90	30.90	29.90
DD34-4001 D/S D/Dens	36.90	35.90	34.90

32 Hard Sector available at same price

20-M BYTE HARD DISKS FOR YOUR MICRO

Part No:	5-MB DS505	10-MB DS510	15-MB DS515	20-MB DS520
Prices exc VAT				
APPLE II	1190.00	1290.00	1390.00	1490.00
IBM-PC	1290.00	1390.00	1490.00	1590.00
SIRIUS/VICT.	1190.00	1290.00	1390.00	1490.00
EPSON QX10	1190.00	1290.00	1390.00	1490.00
DEC LSI 11	1390.00	1490.00	1590.00	1690.00
Z80 System	1190.00	1290.00	1390.00	1490.00
S100 System	1290.00	1390.00	1490.00	1590.00

Slaves may be added at these lower prices

990.00	1090.00	1190.00	1290.00
--------	---------	---------	---------

Complete with intelligent controller, host adaptor, power supply unit, fan, cabling, software and User Manual. Free delivery in the UK.

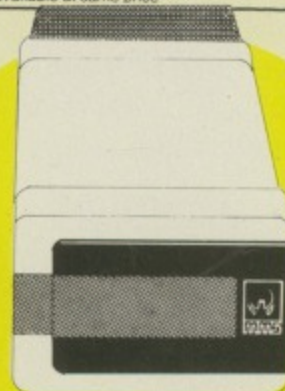

DISKING INTERNATIONAL
FREEPOST
LIPHOOK
HAMPSHIRE
GU30 7BR
UNITED KINGDOM

How to Contact
By Telephone
By Telex
By Prestel
By FAX

DISKING
(0428) 722563
858623 Telbur G
Page 2477310
(0252) 721521

OFFICIAL GOVERNMENT ORDERS WELCOME

We supply all Government bodies including Schools, Universities, Colleges, Hospitals, the Utilities, Research Establishments, Armed Forces, the Ministries and Local Authorities world-wide. We will despatch within 4 (YES 4) working hours from receipt of your official order number received either by post or by telephone, and all orders are handled in the strictest confidence and to the letter. All other customers cheques with order please payable to DISKING. If you are a large establishment, and cannot raise cheques without an invoice please post or telephone us your order, and we will send a pro-forma invoice by return, for your accounts department to pay against.

CREDIT CARD ORDERS

All orders left on the answering machine qualify for a FREE Disking Logobug to stick on your computer.

You may call 365 days a year, 24 hours a day and you may speak for as long as you like, when you leave the following details:-

1. Day-time telephone number
2. Cardholder Name & Address
3. Delivery/Invoice Address if different
4. Your credit card number
5. Part nos. and quantity of your order
6. Normal or First Class post

We welcome Access (Mastercharge), Barclaycard (VISA) and Diners Club International, and there is NO credit card surcharge. Alternatively you may write your C/card No. on your order.

You may leave the rest to US!!

URGENT ORDERS

If you're posting your order, omit the word FREEPOST from our address, and use our normal post code GU30 7EJ and do not forget to stamp it First Class. If you are telephoning your order please make it clear that you wish to pay for your goods to be sent to you by First Class Post.

FIRST CLASS RATES

EXC VAT	5 1/4"	8"
First Ten-Pack	2.00	2.50
2nd and subsequent Ten-Pack	1.50	2.00

TRADE CORNER FREE AEROPLANE

Don't keep sitting there in front of your VDU, get outside and fly our aeroplane. Just call and ask for your flier, and we'll send you our latest trade pack with prices, special offers and sample unlabelled diskette and mailer. We'll also enclose a DPC application form telling you how to buy at our 10,000 prices yet order only in 50's.

BARGAIN CORNER

5 1/4" SUPERLUXE DISK LIBRARIES

Diskette binders at £4.90 each (normally £9.90) p&p 50p each, 10+ post free.

5 1/4" DISKETTES

Supplied in a FREE SEE 10 library box

PRICES EXC VAT	10-40	50-90	100+
S/S 48 tpi Diskettes	13.90	12.90	11.90
D/S 48 tpi Diskettes	20.90	19.90	18.90

Don't be fooled - these diskettes are brand new and come with our normal full money-back guarantee. They are mostly non hub ring labelled or unlabelled BASF, Dysan, Rhone Poulenc, Memorex etc. where the boxes have had the cellophane removed. We are even supplying them in a FREE SEE 10 library box!! At these prices you can't lose - Hurry!

To: DISKING FREEPOST, Liphook, Hants, GU30 7BR, U.K

Qty	Description	Price exc VAT

Total Goods Value exc VAT

Total Delivery and insurance

Sub Total exc VAT

VAT

Value of cheque payable to Disking

NAME:

ADDRESS:

TEL NO:

Or please charge my credit card No

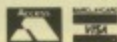

Access, VISA & Diners Cards Welcome



The Graduate.

The first IBM PC
compatible upgrade
for the BBC model B micro.

From
your

Disc
with the
the latest
range of
MS™-DC
customis
allowing
range of
software
compile
available
houses.

The
of upgra
G800, b
user me
(optiona
increase
IBM cor
The G4
double s
drive an
introduc



From only £764.00 the new Torch Graduate will upgrade your BBC Model B to a powerful 16 bit business computer

TECHNICAL SPECIFICATION

- 8088 16-bit processor running at 5 Mhz
- 128K or 256K RAM
- MS™-DOS operating system customised to IBM compatibility
- Model G400 – Single, double sided, high density disc drive (320K formatted)
- Model G800 – Twin, double sided, high density disc drives (640K formatted)
- Integral stabilised power supply
- 2 IBM PC compatible hardware expansion buses
- Software compatibility allows Lotus 1-2-3 and all popular IBM PC business programs to run without modification, subject to the constraints of the BBC keyboard and display
- Disc interface is not required
Keyboard text and graphics supplied by BBC Model B

• THE GRADUATE •

Disc and hardware compatible with the IBM PC, the Graduate is the latest addition to the Torch range of BBC upgrades. It's MS™-DOS operating system is customised to IBM compatibility allowing exploration of the massive range of IBM compatible business software, programming aids, compilers and languages universally available from most major software houses.

Introduction to MS™-DOS

The Graduate offers two levels of upgrade, the G400 and the G800, both with 128K on board user memory as standard (optionally 256K). This can be increased to 1.2 Mbytes with an IBM compatible expansion board. The G400, contains a single, double sided 320K formatted disc drive and provides the low cost introduction to MS™-DOS for the

user who wants real 16 bit power from his Model B.

More data storage

A step up from the G400 is the G800 which offers twin, double sided 320K disc drives for extra data storage. Both the G400 and the G800 provide the possibility of further expansion for networking, modems, etc., via the IBM compatible hardware slots provided

by the Graduate models. Each model comes complete with a well written user/technical manual and connecting leads.

Just plug it in

Unlike other add-ons there is no need to open the BBC to make the connection. The compact and tidy Graduate models simply plug in to the 1MHz bus on the Model B. Within minutes you can be up and running with an IBM PC compatible system that really means business.

The range

Add 256K RAM, 640K disc storage and IBM PC compatibility to the BBC Micro for less than £1,000.

Graduate G400 (128K) £764 inc. VAT
 Graduate G400 (256K) £815 inc. VAT
 Graduate G800 (128K) £949 inc. VAT
 Graduate G800 (256K) £999 inc. VAT

For further information complete the coupon today.

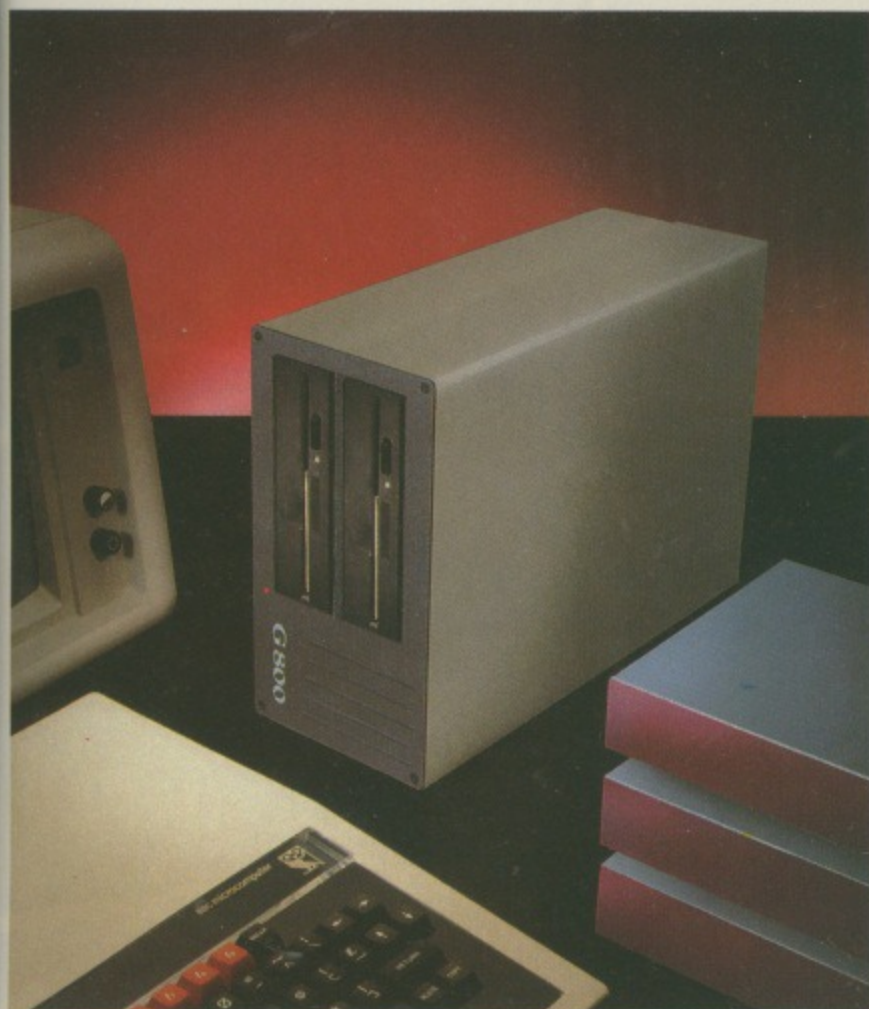

TORCH COMPUTERS



Lighting the way ahead.

Torch Computers Limited
 Abberley House, Great Shelford, Cambridge CB2 5LQ.
 Telephone (0223) 841000. Telex 818841 TORCH G.

The Graduate is manufactured by Torch Computers under licence from Data Technologies Ltd.

To: Torch Computers Ltd., Abberley House, Great Shelford
 Cambridge CB2 5LQ. Telephone (0223) 841000
 Please send further information on the Graduate and the
 address of my nearest dealer.

Name _____

Address _____

Post Code _____

Telephone _____

Introducing BEEBUGSOFT

Until recently a very special range of applications and utility packages for the BBC micro has been unavailable to the general public.

This software has been produced by the BBC user group BEEBUG for its members. BEEBUG members tend to be a demanding and discerning group of individuals; and the range of software produced has been kept to a consistently high standard through their constant vigilance.

As a result, BEEBUG software is highly acclaimed amongst BEEBUG's 25,000 members. Independent reviews from the major computing magazines seem to take a similar view of the software, as you can see from their comments.

SPELLCHECK

The disc based spelling checker for text created on Wordwise or View.

"... invaluable ... fast and reliable ... a worthwhile investment"

PCN February 1984

Disc £19.00

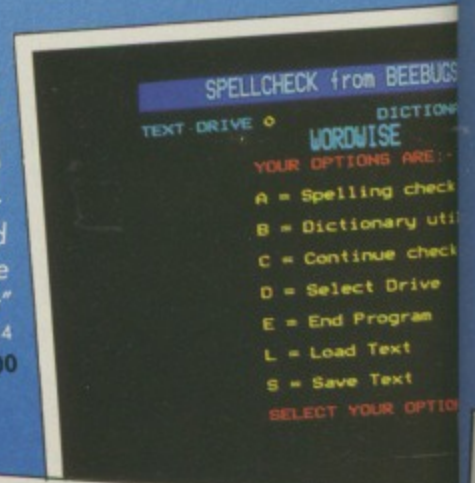

TOOLKIT

27 new commands in eprom to speed up Basic program development and debugging.

"... an indispensable aid"

EDUCATIONAL COMPUTING March 1984

"... worth every penny ... highly recommended"

COMPUTING TODAY June 1984

"... its range of utilities is excellent"

MICRONET May 1984

Eprom £27.00

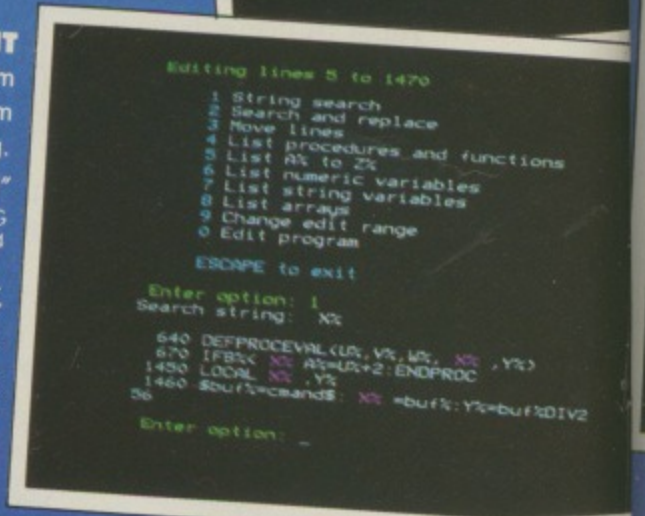

SPRITE UTILITIES

A game writers utility pack enabling high speed arcade games to be quickly written in Basic.

"... definitely recommended"

"... excellent"

ELECTRONICS AND COMPUTING May 1984

"... Sprite Utilities wins through"

ACORN USER May 1984

Cassette £10.00

Disc £12.00

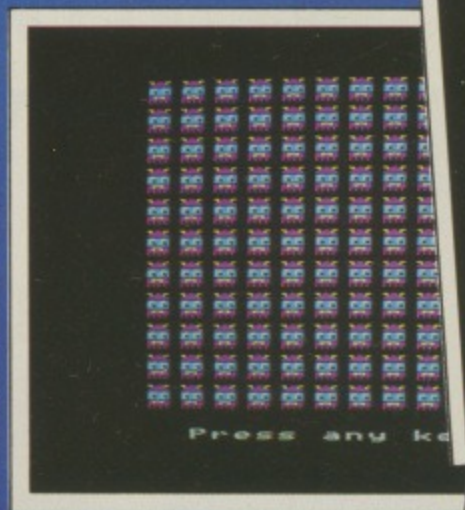

SPRITE DEFINER

FUNCTION + SHIFT KEYS ENTER SPRITE NAME

GHOST



TO MOVE CURSOR USE CURSOR KEYS



PAINTBOX

Probably the ultimate joystick drawing package on the BBC Micro, great fun and highly educational.

"... amazingly versatile ... easy to use ... (one of the most feature laden picture creating programs around)"

"... tremendous potential"

EDUCATIONAL COMPUTING Jan 1984

"... a very sophisticated and versatile utility"

ELECTRONICS AND COMPUTING May 1984

Cassette £10.00

Disc £12.00

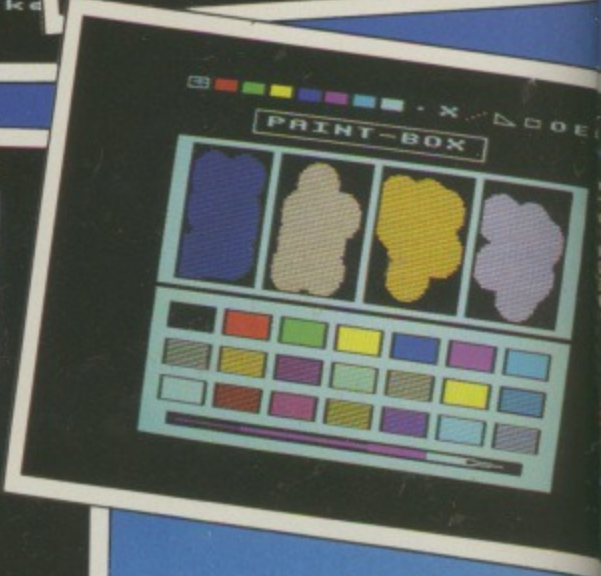

CK from BEEBUGSO
 DICTIONAR
 MOROTISE
 OPTIONS ARE:-
 Spelling check
 Dictionary util
 Continue check
 Select Drive
 End Program
 Load Text
 Save Text
 CT YOUR OPTION



TELETEXT PACK
 A powerful screen editor for quickly creating Teletext Mode 7 screens.
 "... provides teletext editing facilities in a well thought out manner"
 ELECTRONICS AND COMPUTING April 1984
 "... a very neat utility"
 MICRONET April 1984
 Cassette £10.00
 Disc £12.00

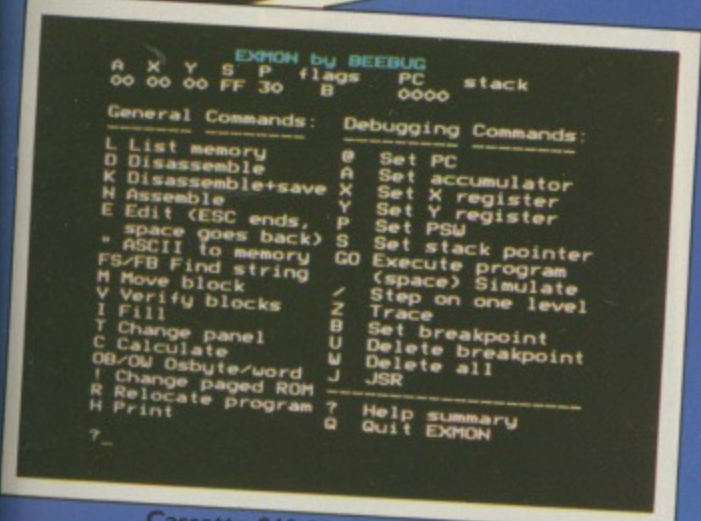

EXMON
 An extremely powerful machine code monitor on cassette or eprom, offering 35 new commands for debugging machine-code.
 "... exceptionally comprehensive ... would be hard to improve upon"
 YOUR COMPUTER August 1983
 "... using EXMON is a delight"
 MICRONET May 1984

Cassette £10.00 Eprom £27.00



DESIGN
 A Computer Aided Design package to allow screens to be quickly created for display, demonstration, handouts etc.
 "... a first rate screen processor ... immense value to schools and colleges"
 EDUCATIONAL COMPUTING April 1984

Cassette £10.00
 Disc £19.00

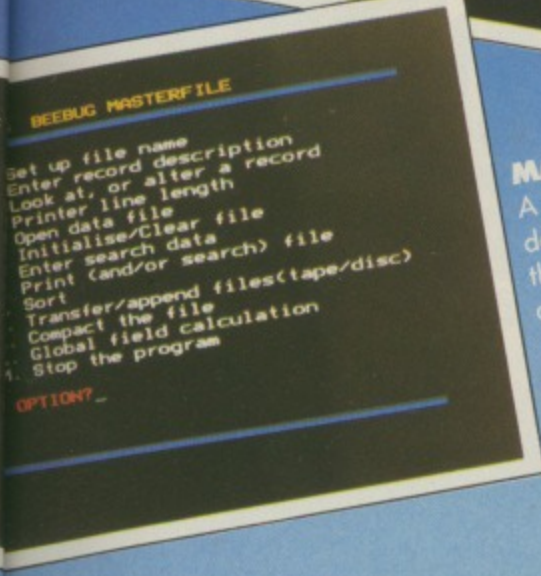

MASTERFILE
 A flexible general purpose database on cassette or disc; the disc version using random access files.
 "... works well and offers an efficient database"
 PCN November 1983
 Cassette £10.00
 Disc £19.00

If you would like to know more about BEEBUGSOFT products, see the advertisers' index of this magazine, or telephone us for a full software brochure.

BEEBUGSOFT products may now be obtained from major dealers including selected branches of W.H. Smith.

Alternatively all products are available from us on mail order from our despatch department in High Wycombe.

BEEBUGSOFT dept 16 PO BOX 109 HIGH WYCOMBE BUCKS HP 10 8HQ

TEL: ST. ALBANS (0727) 60263

Prices include VAT

Strike Control

TWO PRECISION JOYSTICKS

- Set of 2 precision joystick controllers.
- Full analogue control with 2 potentiometers.
- Self centering.
- 2 responsive fire buttons positioned for maximum ease and comfort.

Compatible with
*Acorn *BBC Model B
Computers.

- Short, slimline joystick with thumbcup for sensitive fingertip control.
- Easy and comfortable to hold.
- Rubber feet for table-top use.

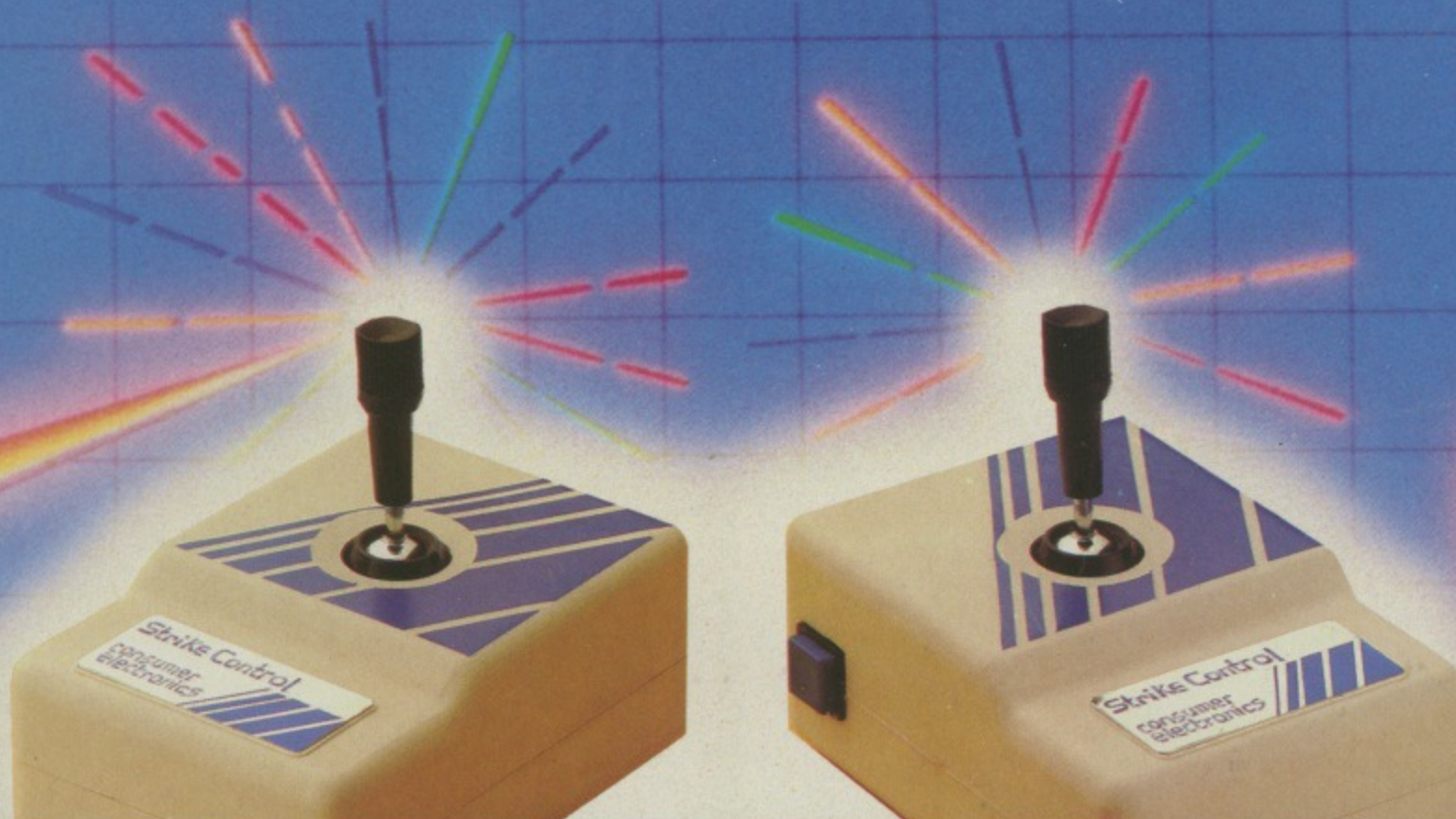

Strike Control is
available from most Spectrum and good computer shops.

consumer electronics limited

Fairbairn, Manchester M35 0HS
Telephone: 061-682 2339

*Trade marks and/or trade names of companies concerned.

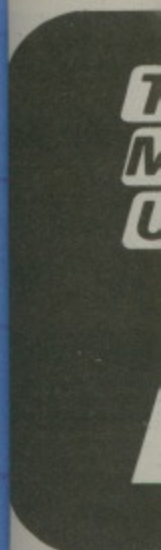

THE future
Micro has
for anothe
with the sig
contract fo
ture and di
This is a
Clive Sincl
pressed hop
ing his s
educational
Commer
deal, Acorn
said: "The
and will
keystone of
system, car
ing the nee

Pe

OWNERS
modore Pe
to change
Micro can
and keep
printers and
The trick
an interface
6 - which
Micro to
disc units a
It conn
Beeb's 1M
auxiliary
nector. Th
printer driv
supplied i
which plug

ABM on target

THE mysterious Acorn Business Machine range is still on schedule to make an appearance in September, according to a source close to the company's decision makers.

The ABM is said to be a full scale business micro incorporating integral screen, disc

drives, and including "significant" bundled-in software.

As a late entrant to the competitive single-user small business market, its penetration is a matter of conjecture.

Even the price range produced a "no comment" response from official Acorn channels.



THE future of the BBC Micro has been assured for another four years with the signing of a new contract for its manufacture and distribution.

This is a setback for Sir Clive Sinclair's often expressed hopes of increasing his share of the educational market.

Commenting on the deal, Acorn's Chris Curry said: "The BBC Micro is, and will remain, the keystone of an expanding system, capable of meeting the needs of a wide

range of users.

"Acorn, in association with the BBC, will be developing the system further to ensure it benefits from future technology, while maintaining its unique core of compatibility".

● Pictured signing the new contract are (left to right) Acorn founders Hermann Hauser and Chris Curry with Byron Parkin and Bill Cotton, managing director and chairman respectively of BBC Enterprises.

BEEB MARCHES ON MOSCOW

ACORN is poised to invade Russia following the announcement that the Western nations have lifted their embargo on sales of the BBC Micro to the Soviet bloc.

The company is currently aiming to secure a major share of the 8 bit Russian market which experts estimate will be worth up to 180 million US dollars over the next five years.

It has already allocated £50,000 to developing a Russian keyboard for the BBC Micro, Russian software and to translate all the technical manuals into Russian.

Spearheading the drive to win a contract for the BBC Micro and training and technical support in Russian schools is 3SL Overseas, Acorn's official Eastern European distributor based in Cheshire. One of their direc-

tors, David Pringle, has recently returned from the latest of a series of promotional raids into Russia to secure a foothold for the BBC Micro.

However Acorn expects to face fierce competition from Sinclair whose ZX 81 and Spectrum machines have also been cleared to be sold behind the Iron Curtain.

The Russian market

has opened up as a result of the United States easing its stranglehold on Cocom - the coordinating committee controlling high tech trade with Eastern Europe.

While the Americans continue to dominate the organisation, which is made up of Nato member countries plus Japan, they have agreed to allow a number of "smaller" computers - including the BBC Micro - to slip through the net.

Networking

But as the United States holds to the line that almost all computers still have military applications - they claim that an Apple II can guide a Minuteman missile - they have insisted that those micros from which the embargo has been lifted cannot be sold with any networking capability.

Acorn International is currently attempting to get a formal ruling on just what this means.

..and China

ACORN International is on the verge of signing an agreement with a company in mainland China to manufacture and distribute the BBC Micro.

"We are a long way down the line to signing a contract", said sales manager Owen Maddocks.

Pet-BBC link

OWNERS of Commodore Pets who want to change to a BBC Micro can now do so - and keep their old printers and floppy discs.

The trick is done with an interface - the Syscon 6 - which links the BBC Micro to Commodore disc units and printers.

It connects to the Beeb's 1MHz bus and auxiliary power connector. The DFS and printer driver routines are supplied in an eprom which plugs into one of

the sideways ROM sockets.

And the standard BBC disc upgrade is not necessary.

On-line Sprites

BBC Micro and Electron users who have a Simonsoft Sprites animation package (version 2) now have a programmers' hot line on 0235 24140. All questions will be answered on this number between 2pm and 3pm weekdays.

LEGAL action is being threatened by *The Micro User* over an inaccurate claim made on behalf of *Acorn User*. The claim is made by *Acorn User's* advertising agents, Computer Marketplace.

It appears in a letter to advertisers, accompanying a brochure announcing a 17.6 per cent increase in *Acorn User's* advertising rates.

The letter states that even with the rate increase *Acorn User* "has a lower cost per thousand advertiser figure".

"This is nonsense",

ACTION ON FALSE CLAIM

said Derek Meakin, managing editor of *The Micro User*. "The truth is that *Acorn User's* advertising rate works out at £5.87 per thousand, while the rate for *The Micro User* is £4.38 per thousand.

"Instead of being cheaper, advertising in *Acorn User* costs a hefty 34 per cent more!"

Teacher goes home to a Beeb

THE classroom computer teachers switch off at the end of the day is more often than not the same model they plug in when they get home... the BBC Micro.

Forty-six per cent of computer-owning teachers have a BBC Micro - twice as many as own the next most popular model, the Sinclair Spectrum - according to a survey conducted by Educational Computing, a leading computer journal in education.

And a similar percentage of prospective teacher-purchasers intend to buy the BBC machine.

The survey of 35,700 schools and colleges indicates that BBC Micros will account for nearly two-thirds of new educational computer

purchases during 1984.

It also uncovered the Beeb's consistently high standing across all types of institution - three-quarters of all schools and colleges have at least one, rising to a massive 84 per cent of colleges.

By comparison, RML's most popular model the 480 Z is used by 18 per cent of institutions and Sinclair's ZX-81 by 16 per cent.

Acorn managing director Chris Curry said: "The survey is important because it spans all types of schools and colleges.

"It results clearly demonstrate that the BBC Micro is the most impor-

tant computer in education today, and one that is proving to be as valuable a tool in universities and colleges as in primary and secondary schools".

The survey also confirms in part a Department of Trade and Industry report that 83 per cent of orders under their "Micros in Primary Schools" scheme are for BBC Micros.

Make a micro quilt

THE BBC Micro is now being used to replace hours of tedious drawing and colouring-in by patchwork quilt designers.

Patchwork design - now a booming hobby in Britain - has countless evening classes, books and TV programmes devoted to its mysteries.

Hard line patchwork addicts are members of the 2,000-strong Quilters Guild. But there are also thousands of quilting freaks in local groups, and

still more working alone.

Each region of Britain has its own traditional patterns, with other designs coming in from Scandinavia and the USA.

Now a Hampshire quilter, Mary Hewson, has developed a package for the BBC Micro called Patbuild.

It lets the designer try out the effect of distortions, repetitions and various colour combinations - all in a fraction of the time it takes with pencil, ruler and felt tips.



SEVERELY disabled Mark Simmons, 19, has just been offered a full-time job as a systems trainee by Nottingham County Council.

Mark, a member of the

A Hertfordshire micro dealer is staging a nationwide software contest with a £1,000 first prize. And they plan to market the winning program on a royalty basis.

Entries are expected to be mostly games, but other software can also be entered.

A spokesman for the dealer, County Computers, said: "We think there are still lots of people out there who can write very good games, but have little chance to get into the business".

Entries should be written for the BBC Micro, Electron, Spectrum or Commodore micros. Run-

£1,000 software prize offered

ners up in the contest will receive prizes of £200, £100 or cash vouchers.

There is no age limit but under-18s must have a parent's signature.

Entry forms are obtainable by sending a stamped, addressed envelope to County Computers, 1 Bucklersbury, Hitchin Herts. Closing date is September 14.

A HA
Micros
during
athon
country
The
bring
election
nation
and the
the job
costing
much.
The
used in
Israel
wrote
lyse a
polling
tion da
The
to pre
some f
final
per ce
The
results
into gr
by a E
came
ment r
The
laid
to sh
fortun
as the
In
best c
job. 7
Ginat
and th
was of
ing f
£30.00
But
found
offered
phics
cation
pound

PRESTEL HEADS FOR THE CLASSROOM

PRESTEL, the British Telecom viewdata service, is launching a new education service for schools - and the BBC Micro will be playing a leading part.

The Department of Trade and Industry, recognising the importance of information technology to schools, is helping to fund the new service.

Schools will be able to subscribe to all the regular Prestel features along with special educational microcomputing applications by converting

their micro into a Prestel terminal.

The service is aimed at Britain's 7,500 secondary schools - many of whom have selected the BBC Micro - and local education authority teachers' and advisory centres.

It has been developed with the Council for Educational Technology (CET) for the UK.

The Department of Education and Science-funded Microelectronics Education Programme, the Scottish Council for Educational Technology and other educational

organisations are also contributing to the new project.

The Prestel Education Service is due to start next January. Special features will include:

- School Link, an educational microcomputing service allowing schools to receive telesoftware programs direct from Prestel down the telephone line.
- Advice, support and ideas to enable schools to develop their use of information technology.
- Information on career opportunities.

BOOST FOR MENTAL ARITHMETIC

IF you thought mental arithmetic for kids was a thing of the past, think again. Griffin Software is staging a rescue operation for youngsters who want to turn two plus two into four without using their calculators.

Available for use on the BBC Micro, Mental Arithmetic is a software package for over-eights providing practice in basic numeracy with two programmes, an individual test and a class test.

Between 10 and 20 questions can be selected in each test, with up to three levels of difficulty.

Three other new titles

for the BBC Micro from Griffin are aimed at helping students understand maths concepts often difficult to grasp in classroom situation.

Tested

Designed for students aged 10 to 16, the packages cover fundamental mental algebra, Pythagoras' theorem and basic trigonometry.

Each title has been written, evaluated and tested with the help of teachers, according to Griffin, and contains full instructions and record sheets to help monitor progress.

000
ware
ize
ered

the contest will
izes of £200.
h vouchers.
no age limit.
8s must have
signature.
ns are obtain-
ding a stamp-
sed envelope
computers, 13
ry, Hitchin.
sing date is
4.

training in
essing and
spent nine
Nottingham
ouncil's man-
vices depart-

NTAL

Micro from
e aimed at
ents under-
s concepts
to grasp in a
ituation.

sted

for students
o 16, the
over funda-
ebra, Pyth-
em and basic

e has been
aluated and
the help of
ecording to
contains full
and record
elp monitor

BBC Micro chosen to cover Israeli elections

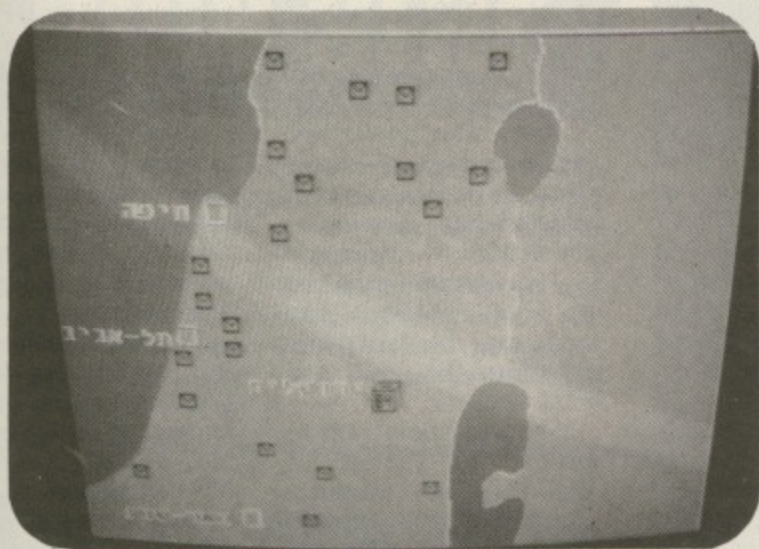

Beeb-produced map of Central Israel showing main cities and locations where a sample poll was to be taken

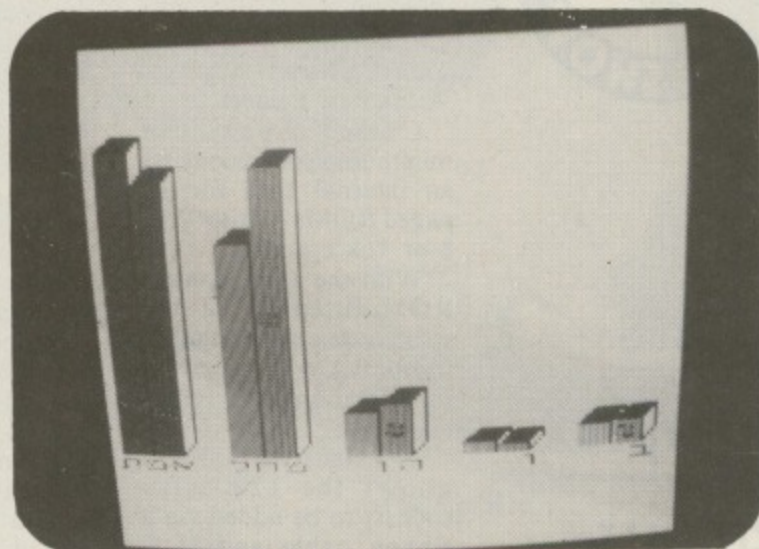

How Israeli viewers saw a bar chart of projected '84 results versus '81 results

A HANDFUL of BBC Micros stole the show during Israel TV's marathon coverage of the country's election results.

They were used to bring up-to-the-minute election night details to a nationwide TV audience—and they were chosen for the job over other systems costing up to 10 times as much.

The BBC Micros were used in two ways.

Israel's top statistician wrote a program to analyse a sample poll at 35 polling stations on election day.

These figures were used to predict the outcome some five hours before the final results—with over 95 per cent accuracy.

Then the election results were translated into graphs and pie charts by a BBC Micro as they came in from a government mainframe.

The graphs were displayed to the TV audience to show the changing fortunes of the 27 parties as the night wore on.

In the search for the best computer to do the job, TV producer Rafi Ginat travelled to Europe and the United States. He was offered systems costing from £10,000 to £30,000.

But in London he found that the BBC Micro offered good colour graphics and data communications for a few hundred pounds. He learnt, too,

that BBC engineers had dreamed up a device to connect the BBC Micro to the video equipment used in TV studios.

And Hebrew software was available, because the micro is widely used in Israeli schools, as well as Jewish schools in the UK. It is exported to Israel by Aldoda Ltd of London and Tel Aviv.

Israeli companies use the BBC Micro for their business communications with Britain and the US.

With a BBC computer plus electronic mail service, companies and news services can save a hefty slice of their international phone and telex bills.

And in a related field, Israel Instructional TV uses BBC Micros with its teletext service, itself based on the BBC's Ceefax and ITV's Oracle.



Hectic meeting between Israel Television and Aschola staff to prepare for election night

Micro soccer starts rumpus

THE cloistered peace of a respected academic institution was shattered recently when students nearly came to blows over a computer game.

They were playing Qual-Soft's soccer strategy game, "League Division One" as part of a computer appreciation course.

But these students also

happened to be apprentices from two rival football clubs, Swindon Town and Reading, on day release at Swindon College.

Passions ran high as the students argued the best strategy for the game, which simulates the problems of a football manager as he steers his team to the cham-

pionship.

Fists were clenched and voices raised as the youths split into opposing factions. Fortunately, reason prevailed before the threatened outbreak of soccer hooliganism.

The session ended in a spirit of friendly co-operation, with team spirit fully restored.

When contacted, a

spokesman for the college laughingly dismissed reports of a full-scale riot in the classroom. And according to lecturer Brenda Lawton, who choose the software, the soccer game was the high spot of the whole course.

League Division One is available for the BBC Micro and an Electron version is also due soon.

**NEW
AT
THE**

**ELECTRON &
BBC MICRO
USER SHOW**

**Card
offers
complex
colour
displays**

LATEST product from Cambridge Microcomputer Systems (CMS) is a high performance, low cost colour graphics card allowing 512 x 256 pixel resolution and an 85 x 32 character screen.

Shown for the first time at the show, the board, coupled with the CMS 6809 universal controller card, is designed to meet the increasing need for colour display of complex technical processes on the factory floor.

Said a spokesman for the company: "We envisage the software for the card being developed on a BBC Micro using our 6809 second processor.

Simple

"The development system costs less than £500 and includes PL9, the ideal applications language for this type of product. It's fast, simple to learn and easily rommed".

The graphics board, complete with 64k DRAM, supports four colour planes, hardware vector and character generator and an internal light pen facility.

CMS also unveiled their IEEE Talker/Listener Controller and a 6502 version of their universal controller.

WEEKS of intense speculation and interest ended when Watford Electronics revealed their latest product – an add-on ROM/RAM card for the BBC Micro allowing up to 128 sideways ROMs to be added externally and 15 internally.

It was one of the star attractions at the July Electron and BBC Micro User Show, held at Alexandra Palace.

Called Apex, the minimum system consists of an internal card for 15 paged ROMs – either 2, 4, 8 or 16k eproms.

With the Apex control ROM fitted 11 of the sockets can be configured for 8k RAM chips, giving in effect an 88k RAM disc.

The control ROM also allows the 128 extra sockets to be added via a ribbon cable and IDC

WATFORD REVEAL THEIR SECRET

connectors in cards of 16 at a time, distinguishing between each external device either ROM or RAM. Filled entirely with RAM, the system supports over 1mbyte of memory!

Despite the power and complexity of the system, Apex uses only four zero page locations, having its own onboard 2k battery-backed workspace.

This means that ROMs requiring large amounts of private workspace should be on the internal board, whereas more

standard ROMs such as word processors can be part of the external system.

Apex uses power saving techniques to ensure that only the socket selected has current, so eliminating overheating.

The internal board can be fitted without any soldering, the card plugging into the 6502 and 8271 sockets.

The latter point was to enable the second of Watford's new products launched at the show to be fitted – a dual density

version of their DFS that will allow up to 360k storage on a single disc surface.

Based on the Western Digital 1770, the code features a complete 8271 emulator that allows the DFS to recognise and work with both single and dual density discs.

Watford will be allowing people upgrading to Watford 1.4 DFS, as it is known, to trade in their old, and rather scarce, 8271 chips, thus keeping the costs down to around that of the standard DFS.



A TRIO of 15-year-old girls who sacrificed their lunch breaks for a month to write a BBC Micro program had their self-inflicted hunger pangs rewarded when they were named as winners of a major contest.

For they provided the best electronic answer to keeping death off the roads in the Greater London Road Safety Contest sponsored by Database Publications.

Karen Dyerson, Angela Moran and Sarah Finucane – all fourth year pupils at Holy Cross Convent School, New Malden – put their heads together at noon each day to come up with "Big Feet", the winning entry.

Incorporating the slogan "When you

Lunch break programs win road safety prize

Wanna Cross the Road Use the Green X Code", the program was selected as the outstanding example of how to use computer graphics to achieve maximum impact.

"We were most impressed with the quality of all the entries which came from schools throughout the Greater London area – but this one really stood out", said Alan McLachlan, a road safety expert and chair-

man of the judging panel.

The girls, accompanied by computer studies teacher John Downing, were guests at the opening day of the show where they were presented with a Pace disc drive as their prize.

"We were particularly delighted to have won because we have only had computers at the school for a year", said John Downing.

"What is even more pleasing to us is that we

are a secondary modern school hemmed in by two grammar schools in New Malden – and they didn't get a look in".

As a result of their success, Karen, Angela and Sarah have all decided to stay on at school to take computer science at A level.

Following the prize presentation by Derek Meakin, chairman of Database Publications, the girls were treated to a slap up lunch at the show.

AL

A big cat guards the Show star

their DFS that up to 360k a single disc

the Western 70, the code complete 8271 that allows the recognise and both single and y discs. will be allow-upgrading to DFS, as it is trade in their rather scarce, thus keeping own to around standard DFS.

AN exotic security operation was mounted when an internationally famed gold artefact, the "Jewelled Hare of Masquerade", was transported across London.

The £30,000 work of art was moved from a city bank vault to Alexandra Palace around the neck of a snarling jaguar – jungle wildcat variety. Once safely there it went on display during the four day Electron and BBC Micro User Show.

Aussies were there

THE market for the BBC Micro is blossoming Down Under.

So much so that distributors from Australia and New Zealand flew in specially to attend the show to see for themselves the latest developments on the scene.

Said Sue Dyson, representing an Australian distributor: "Acorn have sold at least six to seven thousand BBC Micros in Australia and the

market's growing.

"However people feel frustrated that they can't readily obtain the products they see advertised in *The Micro User* – and until recently, even the ones that were imported were heavily taxed".

Such is the interest in New Zealand that distributors there are considering setting up their own UK company aimed specifically at exporting to the antipodean market.

Safety interface

A VERSATILE interface module that's claimed to totally protect your BBC Micro from damaging "electrical feedback" was launched at the show by Pilot One.

The unit, which features four opto-isolated inputs and four 0.5 amp relay driven outputs is said to be

totally isolated from the BBC Micro – not even sharing a common ground line.

It also incorporates its own 5v 1 amp regulated power supply to drive projects without using the BBC Micro's own PSU.

The Pilot One interface, complete with software, costs £60.

Winnie from Pace

NEWEST hard disc on the market comes from Pace, who used the show to launch their own Amcom Winchester drives.

Pace foresee a major application of drives acting as file servers for their E-Net system – a product that's already

creating great interest in educational circles.

Said managing director Barry Ruberry: "The nice thing is that E-Net uses standard Econet interfaces, so users who have Econet level one can upgrade to Amcom Winchester plus E-Net without any problem".



Girl with problems ... the Jewelled Hare and its guardian

ENTER THE HARD ROCK BEEB

MUSICALLY minded BBC Micro owners will be able to compose music and then play it back over digital synthesisers thanks to a new interface from Electromusic Research.

Although synthesisers have long had a standard interface – the MIDI (Musical Instrument Digital Interface) – this could not communicate with the BBC Micro.

The Electromusic in-

terface will allow two way communication.

What this means is that with suitable software, not only can the BBC Micro owner compose music on his micro, but he can play a tune on a synthesiser and have the notes appear on his screen.

The system, which created tremendous interest when demonstrated on the City Music stand, sells at around £159.

USE FOR THE ASHTRAY

ON sale for the first time at the show, the Viglen sideways ROM cartridge system proved to be a best seller.

The package allows you to plug sideways ROMs in and out of your BBC Micro at will, without having to open the case or turn the power off.

It works by running a ribbon cable from the sideways ROM sockets to another socket fitted in the "ashtray" to the left of the keyboard.

ms ze

lary modern ed in by two ools in New d they didn't ult of their ren, Angela have all stay on at ke computer level.

g the prize by Derek airman of ublications, treated to a at the show.

Handicaps beaten by Beeb mike researchers

CHILDREN with speech defects are receiving therapy by playing voice-controlled games on the BBC Micro.

Joint research by Manchester Polytechnic and the North West Computer Club has come up with Micromike, a modified CB radio microphone used to control computer games of varying complexity.

According to Bob Dyke of the Polytechnic's Special Education Micro Electronic Resource Centre (Semerc), some of the games are played through whispers and shouts.

Others are controlled by timing - for example, the player might have to cry "Shoot!" to zap an alien.

Other games are controlled by using certain vowels and consonants, so speech therapists can prescribe different games for different handicaps.

Micromike can be adapted to operate any single-key input program. Dozens of programs are available, and the device also comes in a desktop version for people who cannot hold a microphone.

Semerc is now working on an assortment of switches for the severely handicapped.

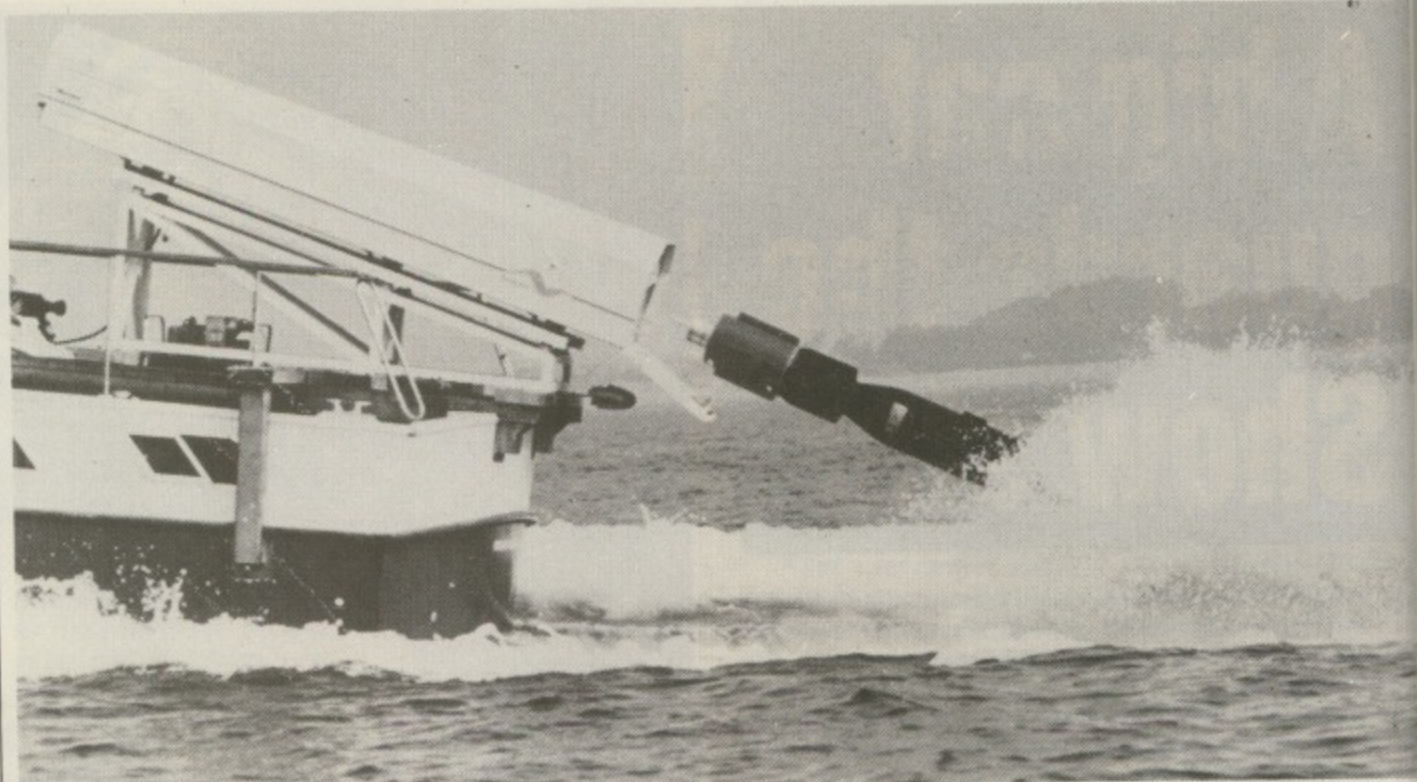

Kingfisher ... the containerised compact Sting Ray launch system

Now BBC Micro gets its calling up papers!

THE BBC Micro is helping develop underwater weapons for the Royal Navy.

Defence contractor Marconi Underwater Systems uses it in the analysis of existing weapons and the development of future ones. This includes the latest torpedoes Sting Ray and Spearfish.

So far, Bedford-based Broadway Electronics has supplied four BBC Micros and associated

peripherals. They are used to create a computer link between Marconi factories in Wembley and Portsmouth.

More computers are to be installed and used in a network system.

Apart from day-to-day project management and scientific modelling, the equipment is used to analyse the forces and stresses which affect torpedoes during launch.

This involves a data logger which records the

position and velocity of the weapon.

This data is retrieved, using the BBC Micro and an ordinary commercial interface. Analysis is then carried out on the BBC Micro or the data can be transferred to a mainframe.

A Marconi spokesman said Broadway was the only company who offered a complete system including installation, commissioning and backup services.

Paul Vaughan, managing director of Broadway Electronics, said: "This illustrates the power of this well-known home computer. It also means we can be proud of offering industry a really in-depth service."

Broadway is part of the newly-formed Mushroom Computer Group, specialising in add-ons for Acorn and Electron computers for business, commercial and educational uses.

The year of the mouse...

THIS year will be remembered as the year of the mouse, according to Nick Pearson, sales director of Advanced Memory Systems of Warrington.

His firm has devised a mouse for the BBC Micro which is being unveiled at the Electron & BBC Micro User show in Manchester at the end of August.

A mouse is a tethered electronic box that you roll over your desk like a Dinky toy. This action moves the cursor around the monitor screen of your micro.

The mouse also has push buttons for entering

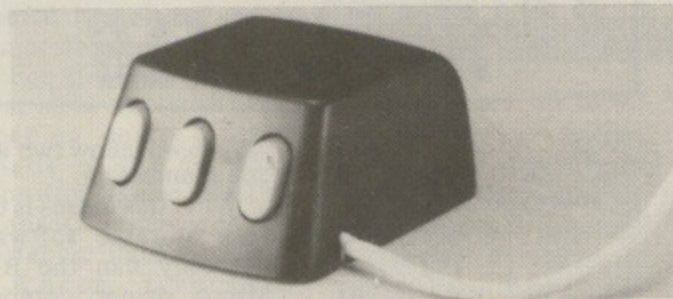

commands.

Says Pearson: "A mouse is not just a nifty way of moving the cursor. It is more like light pens or bit pads than cursor keys. And it's amazingly easy to use".

According to Pearson, the mouse offers BBC users a whole new

approach to working with computers. It also offers them ikon technology.

Ikons are little graphic symbols which represent the services on offer from your micro.

For example, a picture of a filing cabinet represents a file, and if you point the cursor at a

picture of a waste bin, you can use it for getting rid of information you have finished with.

The AMS mouse comes complete with ikon software, but it also works with present BBC software, making it quicker and easier to use - especially for games and word processing.

The price is expected to be around £80, and Pearson is anticipating sales of between 1,000 and 2,000 units a month.

With first deliveries planned for October, he expects to supply 5,000 or more during the run up to Christmas.

DISC DRIVE DOCTOR

DISC drive maintenance is now offered direct to all BBC Micro users by Alpha Disc of Egham, Surrey.

The company offers micro users a direct fixed price basic alignment and recalibration for their disc drives at £20, with the job completed in one week.

"Most drive failures are in this category", says director Jon Pavitt, "and we know how to deal with them simply and quickly."

"We suggest owners either take their faulty drive to their dealer and ask him to contact us, or send it direct to us in protective packaging".

Beeb is flying high

A BBC Micro is at the heart of a prize-winning flight simulator program devised by a Manchester University lecturer.

Dr Bert Bloy, who teaches aeronautical engineering, won a £200 prize in a recent Royal Aeronautical Society contest for a cheap but realistic flight simulator.

It imitates a Cessna training plane, which the pilot controls with a joystick, plus two slide inputs for throttle and flaps.

An unusual feature is that the joystick has built-in "feel". And the space bar can be used as a trimmer to take excessive fore-and-aft loads off the stick.

Instruments are artificial horizon, directional gyro and vertical speed indicator. Air speed and height are shown by digital readouts.

As an aid to landing green lights show the pilot when he is on the glide path, with a red warning light if he gets too low.

But Dr Bloy feels he still has some way to go before his program is perfected.

There is no rudder control as yet, and at present the program simulates landing only. "I am still working on it, and I hope to achieve a complete circuit soon, from takeoff to landing", said Dr Bloy.

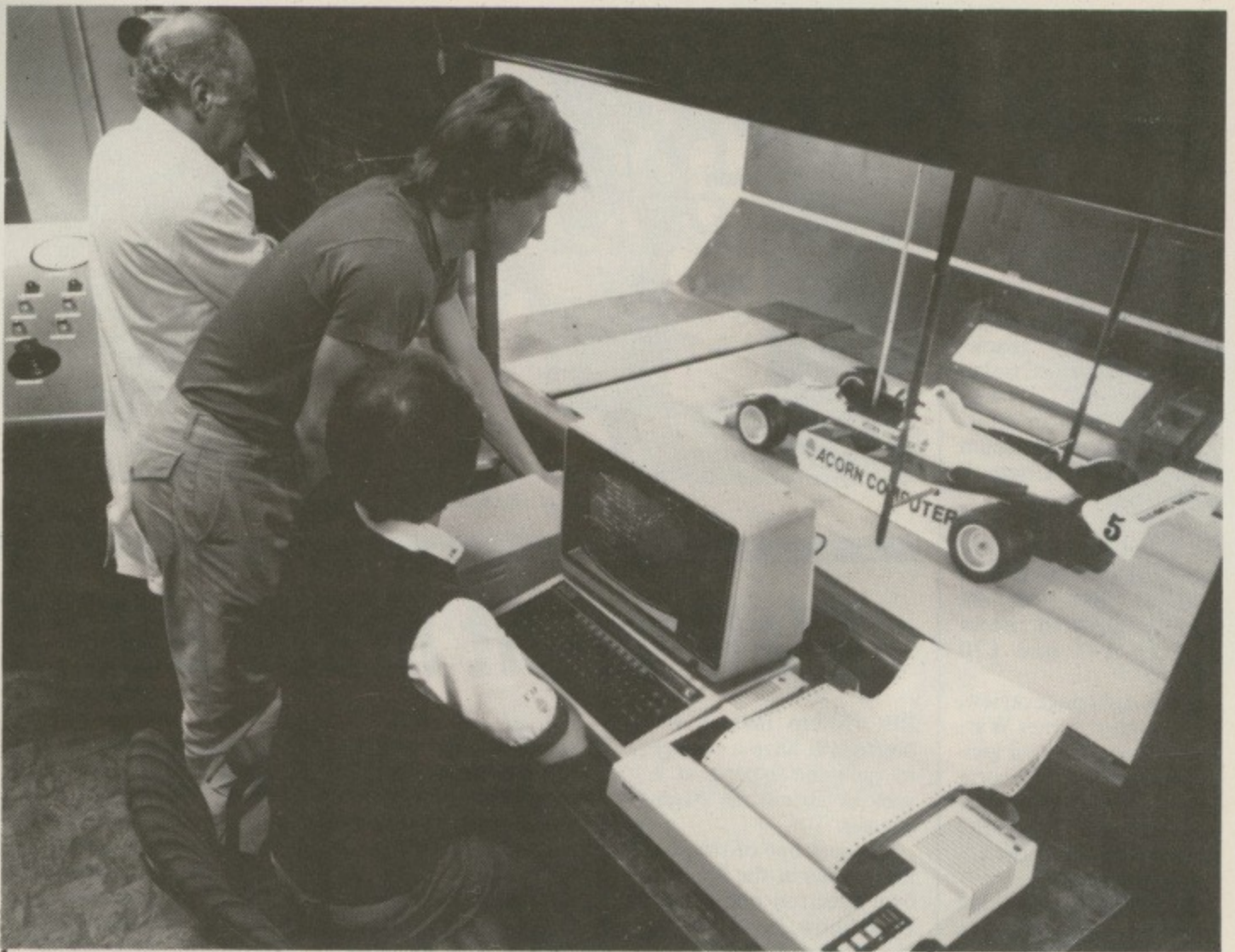

Acorn gets wind up

A BBC Micro is being used in wind tunnel tests at Southampton University to improve the performance of aircraft, racing cars and other motor vehicles.

Benefiting most recently from this facility was Acorn's own Formula 3 Ralt racing car which is driven by David Hunt, younger brother of former world champion, James Hunt.

The wind tunnel enables engineers to measure the aerodynamic

forces operating on the racing car.

To simulate normal race circuit air conditions a 200 horse power fan blows air over a detailed one-third scale model of the car, while a moving belt under the wheels simulates the ground effects of travelling at speed.

Significant

As a result of the wind tunnel testing Acorn expects to achieve a 40 per cent improvement in

the aerodynamic design of the car which should result in a significant increase in speed and cornering potential.

Work on the Acorn car at the University's Department of Aeronautics' wind tunnel will continue into the season alongside work for the Brabham Team which won the recent Formula One Grand Prix in Detroit and Montreal in the hands of current world champion Nelson Piquet.

Pirates get their cards

RISING Edge Data (RED) has patented and started making a system they claim will stop software piracy.

The system uses a card like a credit card which is magnetically coded with key data, different for each program.

A card will be given away with the program, which will not run without it.

The other half of the system is a card reader initially available for the BBC, Spectrum, Commodore 64 and Atmos. This can be left plugged into the back of the micro. Other add-ons plug into the back of it.

The cost of the card reader will be on a par with the average price of software, although some companies may decide to give away the reader as a special offer.

The advantages to the end user might include a fall in the price of software when the manufacturers increase their sales.

LANGUAGE SERIES IS EXTENDED

FOUR new titles for the BBC Micro have been announced by Acornsoft, the software publishing side of Acorn Computer.

They are S-Pascal, Turtle Graphics, Lisp Demonstrations and BCPL Calculations.

S-Pascal, a subject of the popular programming language Pascal, has been specially developed for education.

It compiles directly to 6502 machine code and is said to be ideal for writing small, fast utilities. Library routines allow use of

graphics and access to operating system commands.

Turtle Graphics offers the turtle drawing commands of the Logo language, making an introductory package for teaching elementary geometry, maths and graphics.

Patterns

The "turtle" is an imaginary creature. Controlled by the user, it moves around the computer screen leaving a visible trail from which

patterns are built up.

The Turtle Graphics interpreter supports a subset of full Logo, sufficient to construct quite complex programs with arithmetic operations, loops, procedures and keyword abbreviation.

Lisp Demonstrations contains a set of 11 easy-to-use example programs written in the artificial intelligence language, Lisp.

Applications include computer graphics, the compilation of computer

languages and artificial intelligence.

BCPL Calculations comprises a set of calculation files and example programs for use with Acornsoft's BCPL language system.

Three sets of calculation procedures are provided - floating point, fixed point and fast integer - to meet a wide range of applications.

Prices range from £10 to just under £20. All except BCPL Calculations are available on disc.

Acorn poised for boom

A ROSY future for Acorn is forecast by stock-brokers Henry Cooke, Lumsden and Co, who recently hosted an information technology forum at the National Computing Centre.

They say Acorn's pre-tax profits for 1984 should be around £11 million. Next year the figure is likely to rise to between £15 and £20 million.

In an eight page review, HCL analyst James Warhurst forecasts good general progress for Acorn, but puts a question mark over the future of the BBC Micro's assault on the US education market.

"Without the backing of a large US corporation and against powerful indigenous competitors, the chances of success are limited", says Warhurst.

But he sees better prospects in developing countries, notably India.

In European markets he highlights Germany and Spain as the best likely customers for educational products.



Inside one of the mobile classrooms

Micro goes on tour

THE BBC Micro is being taken on a tour of the country to meet the computer sales staff of W.H. Smith.

The firm found it impossible to train its nearly 1,000 computer salespersons at its Oxfordshire staff college so it has equipped two £30,000 mobile classrooms to do the job.

Walk right in for all the answers

BBC Micro fans in the North will have a chance to quiz the experts at a walk-in forum in Manchester.

It's just one of the star attractions at the North's own Electron and Micro User Show, now back at the Renold Building, UMIST, Manchester.

The show runs from Friday, August 31, to Sunday, September 2.

As well as getting to see everything that's new in hardware and software for the BBC Micro and Electron, you'll be able to hear talks by the writers whose articles you read in

The Micro User.

You won't need an appointment or a special ticket - just wander in and sit down. It's an ideal opportunity to listen to the experts - and to join in the fact-filled question-and-answer sessions.

Launch

Scores of firms will be displaying their new products - many for the first time in public.

Everything on show

will be for sale - often at special low show prices.

Latest to announce a launch at the show is a Warrington firm which has developed a mouse for the BBC Micro.

And the Department of Trade and Industry will be on hand with its travelling Information Technology road show.

All in all, it promises to be a rewarding day out for all BBC Micro and Electron users.

FOLLOWING the Manchester event, two more Electron and BBC Micro User Shows are being held in London this year.

We return to Alexandra Palace for our big autumn spectacular from October 25 to 28, which will see the unveiling of lots of new products.

Then it's back to the New Horticultural Hall in Westminster for our Christmas show, from December 6 to 9.

And more shows are now being planned for next year to satisfy the ever-growing demand.

BARRY WOOD'S TAILPIECE

I WOULDN'T say that Andrew Bray - the whiz kid who wrote the *Watford DFS* and part of the *Advanced User Guide* - has made a lot of money out of it, but rumour has it that he's just started an accountancy course in order to keep track of it all...

TALKING about *Watford*, one of the puzzles of our *Alexandra Palace* show was solved for me by Kevin Edwards, newest recruit to our *Technical Advice* team.

Why, I wondered, would anyone want to have *Watford's* new system that allows you 128 sideways ROMs in a single board?

"Easy", said Kevin, "it's so you can have all the versions of the

Watford DFS in one micro".

BEST question of the show as far as the *Technical Advice* Stand lads were concerned was the anxious: "What exactly is this Mode M you lot keep going on about?"

MIKE Cook was the star of the *Technical Advice* Stand once more. I really must scotch those vile rumours that all the exposure has gone to his head - he's still the same unspoiled lad who'd sell his autograph to anyone.

Mind you, I think he's out of favour with our beloved features editor, who was heard to mutter, as he collapsed

exhausted in the hotel bar, "All that body building, and he still can't carry his own luggage".

WHILE on the subject of the features editor, he took us all by surprise by shaving his beard off just before the show.

At first we thought it was so he could have his photo in the magazine like Mike Cook. Then we decided it was so that people who unwisely took his advice at the last show wouldn't recognise him when they came to exact retribution at the latest event.

All was revealed, however, when he offered to buy a round of drinks for us.

Then we realised why he'd done it. He looks so young and fresh-faced

without the fungus the barman refused to serve him!

NOTICE how the old squirrel abuser has been gaining great satisfaction from pornographic software recently?

The only thing he failed to reveal is that it has been rommed - courtesy of a non-pseudo user group.

And how do you call it?

*FACORN, of course!

WELL, Imagine have gone the way of all flesh, and I think I know why.

Remember all those stories in the press and on TV about 18-year-old kids driving Jensens and earning £35,000 a

year?

It's obvious, they were so busy giving interviews they never had time to write any programs...

I WOULDN'T want to imply that the squirrel factory are threatening legal action against a lot of people, but one of their programmers has revealed they're working on a ROM-based writ generator.

I NOTICED the mag for squirrels has done it again. Last time they printed two blank pages, this time they've remembered the listing, but they've printed it upside down.

It was headed: "How to correct program listings".

A COMPLETE COLOUR MICRO WITH NO HIDDEN EXTRAS FOR AROUND £499.

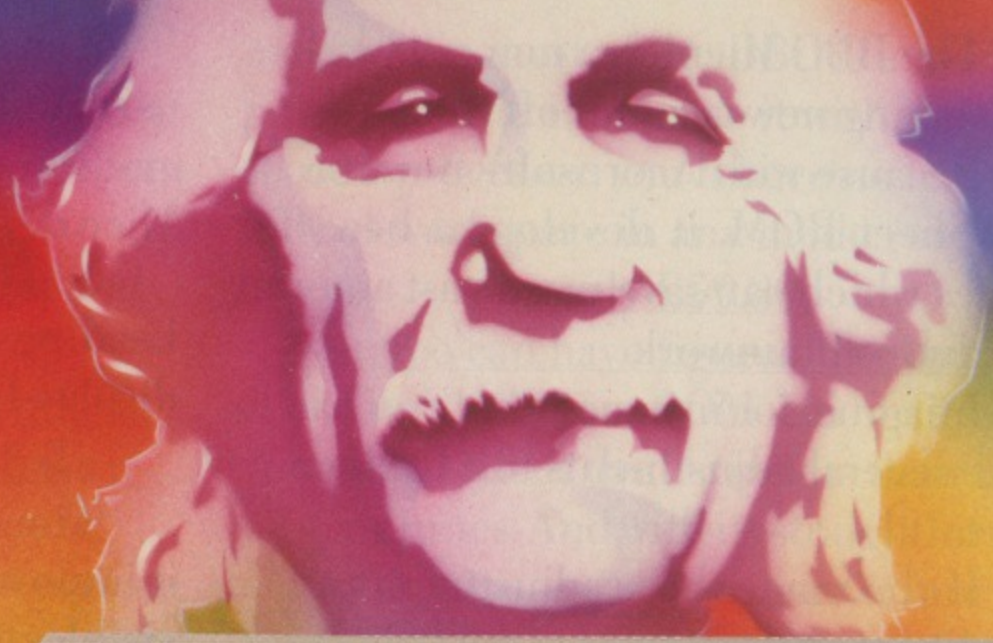

The title of 'genius' is not bestowed lightly on man or machine: those extraordinary qualities and powers of intellect are rare.

Einstein had them in full measure. And so now does the new micro computer from Tatung, designed and built in Britain and appropriately named - Einstein.

Einstein was created by Tatung, one of the world's leading electronic companies, and given the capacity and the remarkable capabilities to compete with computers costing far more.

Its simplicity of operation will appeal to the first time buyer and to businessmen who don't want to lose staff to expensive and time-consuming training courses. At the same time its operating system is both powerful and sophisticated to satisfy the most advanced requirements.

For those who have outgrown their existing primitive machine, the speed and capacity of the 500K built-in disc drive will make all the difference. And for the small businessman, the ability to store and retrieve all information in seconds will be as important as Einstein's built-in flexibility, which allows the system to grow as the business develops.

BUILT-IN 80K MEMORY

Total memory capacity 80K RAM divided into 64K 'user' memory and 16K for colour graphics production.

BUILT-IN DISC DRIVE
500K 3" compact floppy disc drive. Potential for massive extra storage with a second 500K disc drive internally.

BUILT-IN 16 COLOUR GRAPHICS High resolution graphic animation from 32 sprites (definable shapes), 16 vivid colours.



BUILT-IN EXPANSION PORTS
Connection to both TV and optional colour monitor, most printers and other computers via RS232C interface. Also twin joystick ports, 8 bit user port, exclusive Tatung Pipe.

BUILT-IN FLEXIBILITY
Powerful Crystal BASIC. Multi-lingual plus ability to run CP/M.[†]
BUILT-IN VERSATILE SOUND
Sound synthesiser facility includes chromatic music with three voices. Substantial speaker with volume control. Provision for speech synthesiser.

Einstein has them all. Feature for feature, it meets the needs of the novice and the experienced operator, both at home and in the office.

Einstein, designed and built in Britain, is a complete colour micro computer with no hidden extras.

And for under £500 is sheer genius.

TATUNG
Einstein
SHEER GENIUS: AT WORK, AT HOME.

DIAL 100 AND ASK FOR FREEFONE EINSTEIN FOR YOUR NEAREST STOCKIST.

[†]CP/M is a trade mark of Digital Research Inc.

Rebalance this sheet

The BBC Micro can now give an astonishing new account of itself.

Because with Acornsoft's new 16K ViewSheet ROM, it develops a head for figures which can save you a vast amount of arduous brainwork.

Imagine, for instance, that you had to make several adjustments to a balance sheet.

If you made those adjustments on ViewSheet, it would revise the balance automatically in a split second.

Or imagine that you had to add 15% VAT to every figure on a price list containing 500 items.

ViewSheet can add the tax to each and every one of those items simultaneously. And once again, in virtually a second.

As simple as pencil and paper.

ViewSheet is a computer-based spreadsheet, the figure processing version of a word processor.

With 255 columns in width and 255 rows in depth, it's also one of the largest spreadsheets on the market.

Originating the sheet is as easy as originating an ordinary worksheet with pencil and paper.

Because ViewSheet comes with an easy-to-follow reference card.

It enables even the most inexperienced users to feed all the data they need to use and store on disc or cassette, into the BBC Micro.

You can nominate headings and sub-headings. And you can create bar charts to display figures graphically.

Ten windows for perfect vision.

The sheer size of ViewSheet makes it impossible for the whole sheet to be visible on the monitor at once.

That's why ViewSheet has ten windows enabling you to see up to ten different sections of the sheet at any one time.

You can summon the windows onto

the so
Yo
even
ever y
An
ually,
The
By
View
sprea
build
BBC
Vi
Acorn
pack
duce
comb
In
View
any s
mod



sheet in one second.

the screen at the press of a key.

You can cross-reference sections, or even reposition them on the sheet, whenever you need to.

And you can print them out individually, as well as all together.

The possibilities are virtually endless.

By creating special disc files from ViewSheet, you can link two or more spreadsheets together. This means you can build models much bigger than the BBC Micro's considerable memory.

ViewSheet is also compatible with Acornsoft's View word-processing package. This enables you to produce reports and documents which combine text and figures.

In addition, you can use ViewSheet in any screen mode,

making the most of the BBC Micro's potential. And if you use it with the 6502 second processor, you'll have no less than 30K of workspace in any mode.

For only £59.80,

you too can have figures like this.

The ViewSheet ROM can be fitted by your BBC Micro dealer in less than three minutes. And with its straightforward user guide, function

key card and reference card, it'll soon have you juggling figures at lightning speed.

Indeed, at only £59.80, it's an invaluable asset for anyone involved in professional or personal finance, forecasts, formulae and analysis.

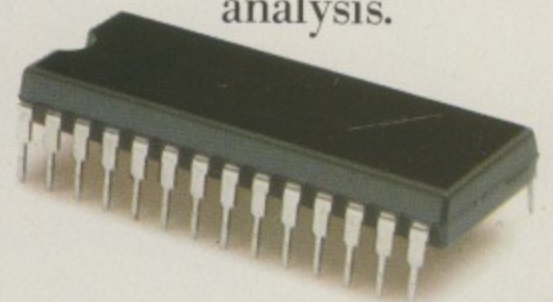

ViewSheet's operations and functions in brief.

The operations supported by ViewSheet are: addition, subtraction, multiplication, division, exponentiation and bracketed operations.

And the functions supported are: ABS, ACS, ASN, SIN, SGN, RAD, ATN, COS, DEG, EXP, INT, LN, LOG, PI, SQR, TAN, MIN, AVERAGE, MAX, CHOOSE, LOOKUP, COL, IE, READ, ROW and WRITE.

ACORNSOFT

c/o Vector Marketing, Denington Estate, Wellingborough,
Northants NN8 2RL. Tel: 0933 79300.

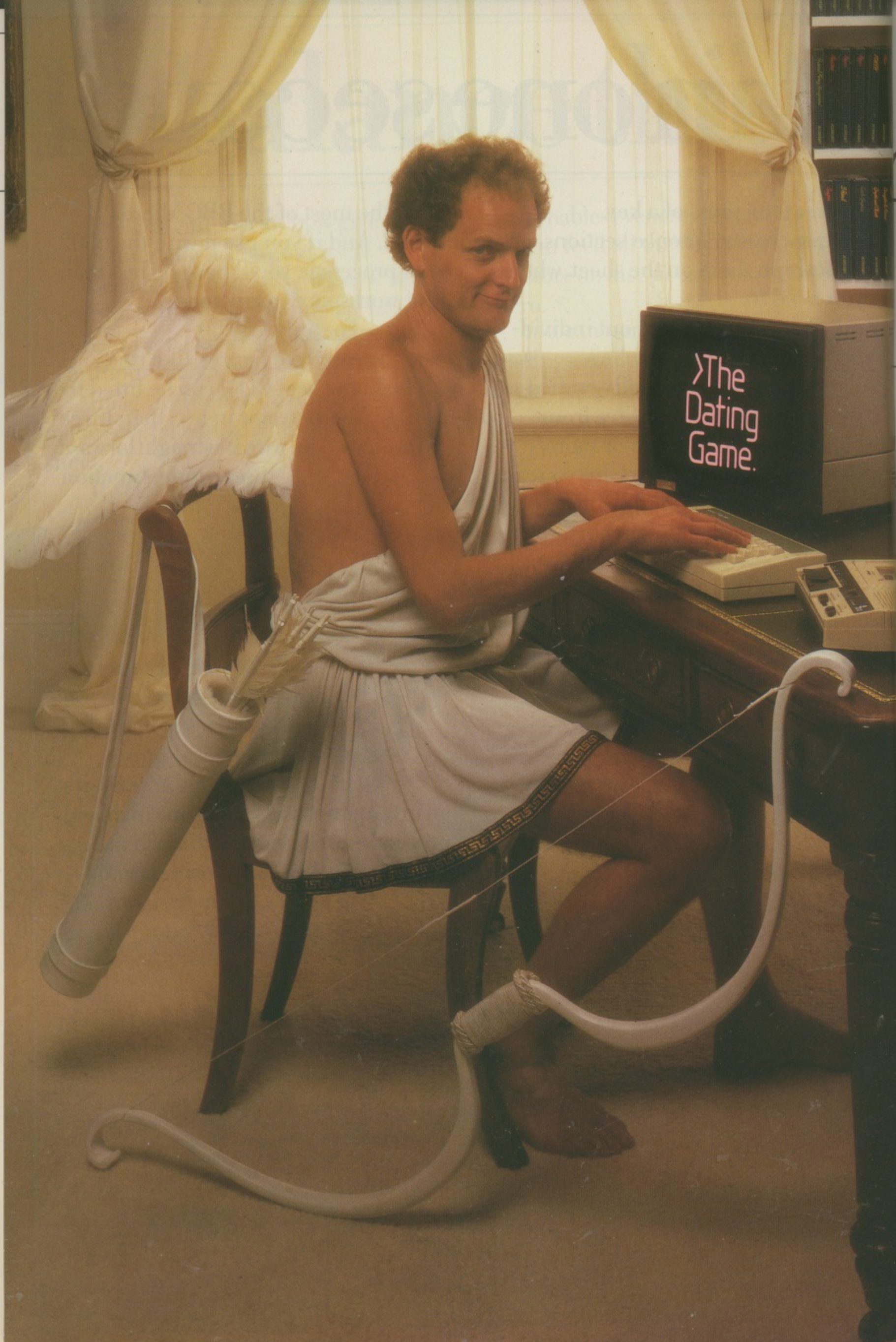

na

ware
grow

an o
ing p
from
mul

will
com
illu
acc

fea
sto
is, s

off
and
wr
Ma
We
NN

The Electron has added even more strings to its bow.

The list of top quality software for the Acorn Electron is growing all the time.

As you can see, there's already an outstanding selection of exciting programs covering everything from monsters to music and murder to marriage guidance.

And ultimately, the Electron will enjoy a range of software as comprehensive as that of its illustrious big brother, the much-acclaimed BBC Micro.

You'll find all the programs featured here at your local Acorn stockist. (To find out where that is, simply call 01-200 0200.)

Alternatively, you can send off for the Electron catalogue and order through the post by writing to Acornsoft, c/o Vector Marketing, Denington Estate, Wellingborough, Northants NN8 2RL. Tel: 0933 79300.

GRAPHICS: Graphs & Charts, Creative Graphics, Picture Maker.

BUSINESS: Personal Money Management, Desk Diary.

EDUCATION: Tree of Knowledge, Peeko-Computer, Business Games.

LANGUAGES: LISP, FORTH, S-Pascal, Turtle Graphics.

GAMES: Starship Command, Monsters, Chess, Draughts and Reversi, Snapper, Meteors, Hopper, Sphinx Adventure, Arcadians, Free Fall.

QUIZZES: Theatre Quiz, Crime and Detection Quiz, Music Quiz, History Quiz, Science Fiction Quiz, '...I Do', The Dating Game.

CHILDREN'S EDUCATIONAL SOFTWARE: Happy Numbers, Timeman One, Timeman Two, Wordhang, Happy Letters, Map Rally.

ACORNSOFT



Watford Electronics

Dept. BBC, CARDIFF ROAD, WATFORD, HERTS. ENGLAND.

Tel: Watford (0923) 40588/37774 Telex: 8956095 WAELEC

ACCESS ORDERS Tel: (0923) 50234



SPECIAL OFFER

BBC Micro (Model B) New Low Price £326

Price includes a **FREE** Data Recorder PLUS five software programs worth £80. (At Watford we give you a great deal for your money)

6502 2nd PROCESSOR	£175
Z80 2nd PROCESSOR	£262

Dust Cover for BBC Micro

Protects your expensive Micro from foreign bodies. **£3.50**

SEIKOSHA GP100A PRINTER

10" Tractor Feed, 80 columns, 50CPS. Normal & Double width Char, Dot res graphics. Parallel Interface standard. SPECIAL OFFER Only: **£144** £7 carr.)

FRICTION FEED

Attachment for GP100A or 250X Printers **£28**

GP-700 Colour Printer Screen-dump routine in ROM FOR BBC Micro **£12**

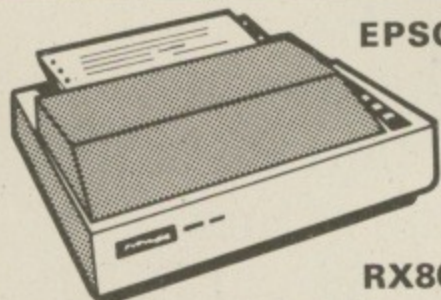

EPSON

RX80

100 CPS, 9 x 9 matrix, dot addressable graphics, condensed and double width printing. Normal, Italic and Elite Graphics. Tractor feed, 10" max width, bi-directional, logic seeking. Centronics Interface standard.

ONLY **£229** (£7 carr.)

EPSON RX80 F/T PRINTER

As above but has both Friction and Tractor Feed. **£245.00** (£7 carr. Securicor)

PRINTER INTERFACE BUFFER

Neatly packaged self contained box, supplied complete with all leads, manual and detachable power supply.

Price: 16K Unit **£115**
Price: 48K Unit **£149**

Epson FX80 Printer

160 CPS, 11 x 9 matrix, proportional spacing, superscripts, subscripts, dot addressable graphics. Normal, Italic and Elite characters. Up to 256 user definable characters. Down loadable character set. Condensed and double width printing. Full proportional spacing. Four user defined margin positions. Tractor and Friction feed. 10" maximum width Bi-directional, logic seeking Centronics interface standard.

ONLY **£319** (£7 carr.)

Type	Ribbons	Dust Covers
MX80FT	£4.75	£4.50
MX100/FX100	£10.00	£5.25
FX80	£4.75	£4.95
RX80	£4.75	£4.50
GP80	£4.50	-
GP100	£4.95	£3.95
GP250	£5.95	£3.95
GP700	£18.50	-
KAGA KP810	£5.95	-
CANON PW1080	£5.95	-

RX & FX PRINTER INTERFACES

RS232	£35	RS232 + 2K Buffer	£59
IEEE 488	£65	2K Parallel	£58

BROTHER HR-15 DAISY-WHEEL PRINTER

An exceptionally high quality daisy wheel printer at the price of a dot matrix printer. 18CPS; bi-directional, 3K of buffer; has clear buffer facility, carriage skip movement, proportional spacing; underlining; bold print and shadow print. Prints in two colours; super and subscript facility. Impact control facility to vary pressure on paper for making carbon copies. Has Centronics parallel or RS-232 interface. Connects directly to BBC Micro. A ribbon cassette plus a separate red ribbon. Optional extras: single sheet feeder takes up to 150 A4 sheets; a keyboard that transforms HR15 into a sophisticated electronics typewriter. Attractively finished in beige.

ONLY **£349**

Single Sheet Feeder	£199
Keyboard	£150
RIBBONS:	Carbon £3 ; Fabric £3 ;
	Multistrike £6

LISTING PAPER (Plain)

1,000 Sheets 9 1/2" Fanfold Paper	£7
2,000 Sheets 9 1/2" Fanfold Paper	£13
1,000 Sheets 15" Fanfold Paper	£9
Teletypewriter Roll (Econo paper)	£4

PRINTER LABELS

(continuous stationery)

1,000 90 x 36mm	£5.50
1,000 90 x 49mm	£7.75
1,000 102 x 36mm	£6.25

Carriage on Printer Paper or Labels **£1.50**

BBC Micro WORD-PROCESSING PACKAGE

A complete word processing package consisting of: BBC Model B, Zenith 12" Green or Amber Monitor, Twin 200K highly reliable (1 year warranty) Cumana Disc Drives in matching beige colour, the popular WORDWISE word processor, Watford's own highly sophisticated 62 File DFS interface fitted, world renowned Brother HR 15 Daisy Wheel Printer, Gemini's BEEBCALC Spreadsheet Analysis, MAILING LIST and DATABASE Softwares on Disc. 10 blank 3M Discs (Lifetime warranty). A 4 way mains distribution socket. 10 blank diskettes, 500 sheets of fan-fold paper. Manuals and all the leads. To enable you to try your Micro around, we shall pack it in our Antique Brown leatherette Attache carrying case.

ONLY **£1,199** (carr. £15)

(P.S. We will alter the package to suit your requirement. Call in for a demonstration.)

KAGA KP810

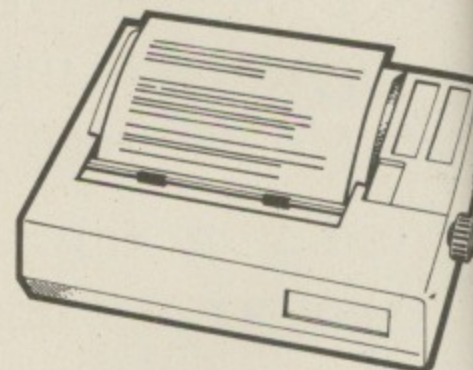

This new JAPANESE printer has EPSON FX/RX compatible commands. 140 CPS Dot matrix printer, offers **NEAR LETTER QUALITY** print in a 23 x 16 dot matrix in addition to the standard Epson style type-faces on the 11 x 9 matrix. Friction feed, Adjustable tractor feed, Single sheet feed and built-in Paper Roll Holder. Normal, Italic, Enlarged, Condensed, Super and Subscript, Dot addressable graphics (8, 9 and 16 pin modes). Proportional spacing. (Optional extra Down loadable character set in 8K ROM or RAM). **NEAR LETTER QUALITY** print, selectable at switch on. 10" maximum width, bi-directional logic seeking. 3K Buffer. Half speed quiet mode. Convenient Paper-out sensor switch. Centronics Interface standard. All this plus our no quibble 12 months warranty.

Special Introductory Offer: ONLY **£249**
RS232 Interface + 2K Buffer **£28**

KAGA KP910 PRINTER

Similar features as the above KP810 printer but has extra wide carriage. Will accept upto 17" maximum width paper. 156 column normal and 265 column condensed.

ONLY: **£349**

PRINTER LEAD 36"

Ready made printer lead to interface BBC Micro to EPSON, SEIKOSHA, NEC, STAR, JUKI, BROTHER, SHINWA, CANNON, KAGA, or any Centronics Parallel Printer.

Special Extra long 5 feet Cable **ONLY £7**
£10

At last! - the Micro Computer ELECTRONIC that will suit b requirements. EPROMS from 2716 - 2512 27128. Our P make sure the too fast nor to recommended EPROMS (any brains out). This extreme your needs o Basic program subsequently Suitable for users!

Just look at
● **COMPLE**
Housed in its power supply Bus - Simple
● **FULL SO**
complete with code ROM b understand r Verification, Editing, Savi This softwar prepared rou professional package.
● **ACORN**
1MHz connect addressing n can still add IEEE 488 T
● Allows m an EPROM

ONLY **£7**

TEX

EPROMS n expected li brains out world; take chips a we affordable.

Two versio

● **EPROM**
Erases up
● **EPROM**
an incorp automatic Eraser is c Spare 'UV

PLAS

for D

EPROM PROGRAMMER

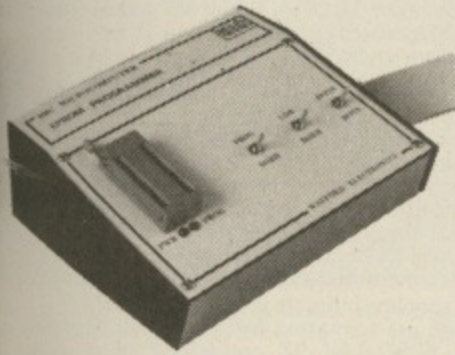

At last! - the EPROM Programmer for BBC Micro Computer from WATFORD ELECTRONICS

that will suit both your pocket and all your requirements. Programs all popular types of EPROMS from 2K bytes up to 16K bytes - 2716 - 2516 - 2532 - 2564 - 2764 - 27128. Our Programmer has been designed to make sure the EPROMs are neither programmed too fast nor too slow; just at the right speed as recommended by the manufacturers of the EPROMs (any deviation in timings can burn their brains out).

This extremely powerful system is designed for your needs of TODAY & TOMORROW! - BBC Basic programs can be copied into EPROM and subsequently re-loaded faster than from a disc! Suitable for both hobbyist and professional users!

Just look at these features:

- **COMPLETELY SELF CONTAINED** - Housed in its own sturdy case - Uses its own power supply - connects directly to the 1MHz Bus - Simple and Safe!

- **FULL SOFTWARE SUPPORT** - Comes complete with simple to use fully machine code ROM based software and easy to understand manual. Facilities include Verification, Reading, Virgin Testing, Writing, Editing, Saving, Loading and more! NOTE!! - This software does not simply comprise hastily prepared routines to get you going, but is a professional, purpose designed applications package.

- **ACORN BUS COMPATIBLE** - Use of the 1MHz connection complies with all Acorn addressing recommendations - That means you can still add-on such things as the TELETEXT, IEEE 488 TUBE and PRESTEL

- Allows more than one program to reside in an EPROM using the ROM Filing System.

ONLY £79 incl. Manual (£3 carr.)

TEX EPROM ERASERS

EPROMs need careful treatment to survive their expected lifetime. Rushing it could burn their brains out. So cop-out of this helter-skelter world; take it easy the TEX way and give your chips a well earned break. Cool, gentle and affordable. EPROMPT does it properly.

Two versions available:

- **EPROMPT EB** - The standard version. Erases up to 16 chips. £28.00

- **EPROMPT GT** - Erases up to 28 chips. Has an incorporated safety switch which automatically switches off the UV lamp when the Eraser is opened. £30.00
Spare 'UV' Lamp bulbs. £9

NEW DESIGN PLASTIC LIBRARY CASES

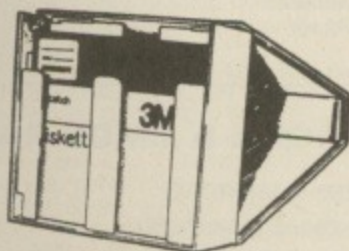

for Disc Storage 5 1/4" (holds 10) £2

MONITORS

- **MICROVITEC 1431**
14" Colour Monitor, RGB Input. (as used in BBC programmes) FREE Interface Lead. ONLY £173

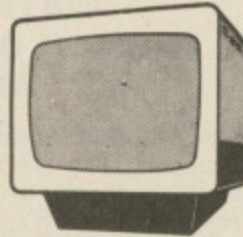

- **MICROVITEC 1451**
Hi-res 14" Monitor incl. lead £295
- **MICROVITEC 1441** Super Hi-res
14" Colour Monitor £249
- **KAGA 12"** Standard resolution colour
MONITOR/COMPOSITE VIDEO ONLY £195
- **KAGA RGB 12"** Medium
Resolution Colour £195
- **KAGA RGB 12"** High Resolution Colour £259
- **BNC** Connecting Lead £3
- **RGB** Connecting Lead £5
- **ZENITH 12"** High resolution, jitter free
picture, Amber or Green £75

Carriage on Monitors £7 (Securicor)

5 1/4" DISKETTES

(Lifetime warranty)

Why settle for less, Buy the best.

- 10 SCOTCH 3M Diskettes S/S S/D £15
- 10 SCOTCH 3M Diskettes S/S D/D £17
- 10 SCOTCH 3M Diskettes D/S D/D £28

DISC ALBUMS

Attractively finished in beige leatherlook vinyl. Stores, protects and displays 20 discs in double-sided clear view pockets. ONLY £4.25

LOCKABLE STORAGE UNITS

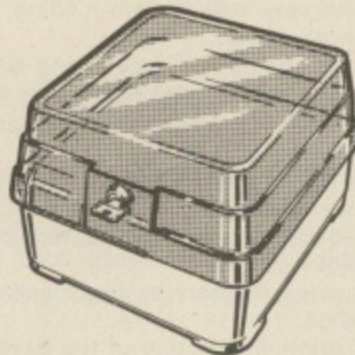

Attractively finished, strong beige plastic base fitted with dividers. Smoke acrylic top. Supplied with adhesive title strips for ease of filing.

- M-35 Holds upto 35 mini discs £13
- M-85 Holds upto 85 mini discs £18

FLOPPY HEAD CLEANER KIT

Unless your Office/Home is dust free, you should clean floppy-heads at least once a week to avoid the risk of cross contamination. Very simple to use. Only £14

MONITOR CRT SCREEN CLEANING KIT

The anti-static spray controls dangerous static charges on the screen surface and ensures its optical clarity. £12

KEYBOARD CLEANING KIT

£16

PRINTED CIRCUIT BOARD CLEANING & LUBRICATION KIT

£14

DISC DRIVES CASED WITH CABLES (less PSU)

(All Drives are NEW SLIM-LINE Type)

NEW LOW PRICES

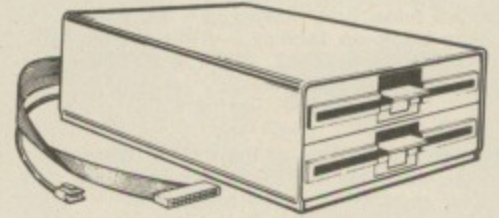

- **CLS 100** Single, TEC Single sided 40 track
100K, 5 1/4" Disc Drive £115
- **CLS400** Single, Mitsubishi Double sided 80
track 400K, 5 1/4" Disc Drive £165
- **CLS400S** Single, Mitsubishi Double sided
40/80 track Switchable, 400K, 5 1/4" Disc Drive
£199
- **CLD200** TEC Single sided 40 track 200K,
twin 5 1/4" Drives £225
- **CLD800** Mitsubishi Double sided 80 track
800K, 5 1/4" TWIN Drives £325
- **CLD800S** Mitsubishi Double sided 40/80
track switchable, 800K, Drives £249

(CUMANA) DRIVES CASED

WITH PSU & CABLES

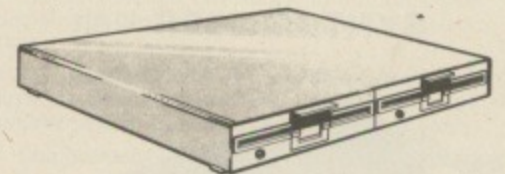
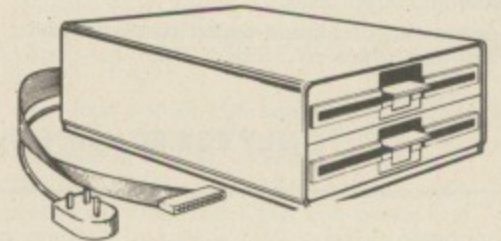

- **CS100** TEC Single sided 40 track 100K 5 1/4"
Single Disc Drive £139
- **CS200** TEC Single sided 80 track 200K 5 1/4"
Single Disc Drive £205
- **CS400** Mitsubishi Double sided 80 track
400K 5 1/4" Single Drive £225
- **CD200** TEC Single sided 40 track 200K 5 1/4"
TWIN Disc Drives £245
- **CD400** TEC Single sided 80 track 200K 5 1/4"
TWIN Disc Drives £365
- **CD800** Mitsubishi Double sided 80 track
800K 5 1/4" TWIN Drives £425
- **CD800S** Mitsubishi Double sided 40/80 track
Switchable 800K TWIN Drives £465
- **SPARE DRIVE CABLES, SINGLE £6; DUAL £8**
- **DFS Manual (comprehensive) £7.50 (No VAT)**

P.S.

1. You do not require Formatting Discs when using our DFS as the formatting program is in the ROM, nor do you require expensive 40/80 track switchable drives as with our DFS you can read and write both 40 and 80 track discs in an 80 track drive (software switchable).

2. Our **MITSUBISHI** Slimline Disc Drives are Double Sided, Double Density, 1 Megabyte. Track density 96 TPI, track to track access time 3mSec. They are fast, efficient and highly reliable.

Continued



MK 2 13 ROM SOCKET EXPANSION BOARD

Now all lines fully buffered - On board battery back-up facility - will now accept EPROMS 2716, 2732, 2764 & 27128 and ROMs 6116, & 6264.

Simply plugs into one of the four ROM sockets currently available in BBC Micro. There are only 5 solder connections to be made. Full instructions are supplied. This board has been ergonomically designed to enable the user, easy further expansion inside the Micro, e.g. Double Density Board, Torch Board, etc. (At Watford, we think ahead.)

Our Mk2 13 ROM Socket Board enables the User to increase the sideways ROM capacity from the basic 4 sockets upto full 16 capable of being supported by current operating systems. In addition the board is designed with the facility to hold upto 16K RAM, which when switched into operation is automatically selected by any WRITE signal to the Sideways ROM area. This gives the User the ability to write a utility or language and upon pressing break have the utility or language up and running (new ROM software can be developed and tested in situ.)

The Board gives the User, plenty of freedom to explore the possibilities of the new paged ROMs due in the coming months and offers them the chance to develop their own. All lines are fully buffered and the Board meets or exceeds all timings for operation in the BBC Microcomputer. When fully populated, the ROM Board consumes less than half the recommended maximum current limit.

Supplied ready-built and tested complete with fitting instructions.

ONLY £32.50 (carr. £1)

Versatile BEEB SPEECH SYNTHESISER Unit



SIMPLY the best! - An unlimited speech synthesis system. Complete with easy-to-follow manual. Controlling software is in ROM so no Cassette Loading problems!

PHONEMES for word synthesis - That means unlimited vocabulary! No extra speech dictionary chips to buy!

BUILT-in Library of approximately 500 words to get you started.

ENGLISH accent - Utilises inflexion techniques to produce highly comprehensible speech.

EASY to use system - Just plug the software ROM into a socket, the Speech unit into the User Port, and away you go! No specialised 'dealer upgrade' required!

COMPACT unit - The whole system is built into a small case - easily tucked behind the computer. Auxillary output socket provided for direct connection to an external amplifier.

HOURS of fun! - Suitable for any application - Games, Educational Programs, Specialised Packages.

We know this all seems to good to be true but **DON'T BE LEFT SPEECHLESS!** Order your Versatile Speech Unit now!

Only £44

WATFORD'S LAUNCH OF THE YEAR APEX

The ultimate expansion system for the BBC microcomputer. It enables you to increase memory capacity to 2+/MEGABYTES including BATTERY BACKED-UP RAM.

The system consists of a mother board which fits inside the BBC and further daughter cards can be connected externally.

The internal card has the following features:

- 15 ROM/RAM sockets, 11 of which can be configured as 2716, 2732, 2764, 27128 EPROMS or ROM equivalent devices or as 6264 RAMs. Any RAM is Automatically battery backed-up and it's contents preserved when the power is turned off.
- The battery is recharged every time the machine is turned on and lasts several months, depending on the number of RAMs fitted.
- There is very little extra current drain, even with a fully loaded board as only the presently active ROM is powered up. In fact the fully populated board uses only 300mA.
- The board reduces micro bus loading by up to three ROM loads, which improves reliability and performance.
- Installation is extremely simple. There is no soldering required. The board is rigidly held by two 40 pin sockets and five support posts. A ribbon cable can be brought outside the computer and up to 8 external cards added. This enables the user to plug-in up to 142 paged ROMs. The cards have following features:
 - Each card can accommodate up to 16 devices each of which can be configured as 2716, 2732, 2764, 27128 ROMs or 6264 8K RAMs.
 - Battery backup is provided from the internal card.
 - Only the active ROM is powered up permitting many external ROMs to be added with very little current loading (1/100mA per card/).

The system comes with controlling software in ROM. The utilities supplied are as follows:

- APEX - replies with the device number currently being accessed.
- APEX C - toggles between the colour and standard black and white messages.
- AL - loads from any device, regardless of the data type.
- AS - saves memory to any specified RAM device.
- AD - prints a directory of the devices present in the system, i.e. ROMs present and files stored. This also reports on the amount of free storage space.
- AF - asks for the free RAM devices.
- LA - repeats the last command to paged ROMs.
- AT - enters a memory testing routine. This will write a test pattern into the memory and read it back out again. If a fault is found, it is reported to the user. This test continues until Escape is pressed.
- RDISC - activates APEX as a filing system which then treats all free APEX RAM in the system as a continuous 'RAM-DISC'. All commands have similar format to the DFS and transfer is possible between the two systems.

The complete computer system bus is available to the user, so that other cards/devices could be added such as EPROM programmers, second processors, Winchester disc drives, clocks, etc. By racking the cards you eliminate the tangled mass of cables that usually accumulates around the micro.

A comprehensive operating manual is supplied with every APEX Board. Please write in for further details and prices.

BEEBFONT ROM

BEEBFONT is a remarkable new concept in BBC software, exclusively available from Watford. Once fitted, the 16K ROM will enable you to produce attractive text displays in following different styles:

- ★ It works in modes 0, 1, 2, 4, using full colour.
- ★ Simply use Ctrl-V to select the font and all further screen output will be in a new style.
- ★ Even the ordinary Beeb character set can be enhanced by doubling height or width and emphasising to give bold print.
- ★ A comprehensive editor is included which enables the user to design his own characters.
- ★ A spooling program is provided, which enables pre-formatted text files to be displayed on an EPSON FX, RX, and NEC Printers, using the full range of character styles. (Please specify printer type when ordering). Can be used with WORDWISE.
- ★ This really must be one of the most original and exciting products of the year.
- ★ A twenty page manual is provided and the demo/editor software comes on disc or cassette (please specify when ordering). **ONLY £39**

THE ULTIMATE DFS FOR BBC MICRO

by

Watford Electronics

Highly acclaimed at The ACORN and BBC MICRO USER Shows. What do the independent press say?

Good value for money - *Beebug Aug. '83*
A very worthwhile package - *The Micro User*
You'll be buying a very powerful package - *Personal Computer News*
Superior DFS; Excellent disc sector editor - *Computer Answers*

Without a doubt, the most sophisticated DFS Software yet written for BBC Micro Computer. This powerful new DFS is fully compatible with ACORN DFS yet has much increased power due to additions, carefully designed to make life easier in normal use. It consists of over 14K of efficiently written machine code. It is entirely self-contained and so does not require a utilities disc to function.

Please write in for full technical specification.

PRICES:
DFS (Disc Filing System) ROM

Complete Disc Interface Kit including DFS ROM & Fitting instructions

Disc Filing System Manual. Comprehensive and clearly written £7.50 (no VAT)

P.S. We will exchange your existing ACORN DFS or PACE (AMCOM) DFS for Watford's high sophisticated 16K DFS ROM for

Watford's DFS is exclusively available from Watford Electronics. We do NOT retail through dealers. Every ROM carries a label with our logo and a serial number.

Now available:
Acorn DFS Kit

EPROMs & CMOS RAMs

- 2764-250nS (8K ROM) £5.00
- 27128-250nS (16K ROM) £24.00
- 6116-150nS (2K RAM Low Power) £5.00
- 6264-150nS (8K RAM Low Power) £2.00

BEE

"Makes

Are you fed u
printer manu
for? Need ser
booklets? The
ROM.
A machine co
● 'Single' k
sequences for
paper movem
without effec
● This rom
printer for
instead of
'OC' a sing
Print Style

● Automati
listings. PRIM
size alternat
using binders
● Form fe
available on
margin.
● User defi
are printed a
● ★ Comma
NEC, MX
Operates v
● Fully fu
wordproce
Supplied c
manual.
(When or

A highly sop
providing so
plus window
DSWORD c
graphic coo
mode 7 'pix
*IMAGE U
graphic scr
Handles FL
double-heig
optional pa
only need s
parameters
● V<scale,
numbers gi
dump size
tother dum
screen mod
● R <0-3
degrees.
● I<inden
● X <min
of the scre
window, ab
given.
● P Physi
(otherwise
darkest.)
● T Two.1
● M <ma
● E Contr
characters
more clear
● C All m
dumps.
● *GWIN
Screen, it's
using the
● *TIMAC
dump of t
● *TWIN
DUMP OU
facilities li
£5.00 as well, m
ideal for C
KAGA/TA
EPSON M
DMP100/
£2.00 Comprehe

ROM

concept in BBC from Watford. enable you to in following

4, using full

font and all new style. character set can be width and

cluded which characters.

which to be displayed Printers, using (Please specify used with

most original

ided and the disc or cassette **ONLY £39**

DFS MICRO

electronics

RN and BBC independent

Aug. '83 Micro User package -

editor -

icated DFS Computer. compatible with ed power due make life over 14K of is entirely self a utilities disc

ification.

£29

it including instructions £99

prehensive and £7.50 (no VAT)

ACORN DFS Watford's highly £25

le from tail through any with our LOGO

£95

RAMs

£5.95

£24.00

£5.75

£28

WATFORD'S BEEB PRINTER ROM



"Makes Printing Childs Play"

Are you fed up with not being able to unravel your printer manual and use all those features you paid for? Need sensible paging for use in the creation of booklets? Then you certainly need our Beeb Printer ROM.

A machine code printer utility in ROM.

● 'Single' key operations replace control code sequences for underline, font and size selection, paper movement, etc. Up to 30 come pre-defined, without effecting normal fn key usage.

● **This rom allows easy control of your printer from 'Within' WORDWISE text. Instead of long escape sequences, you just 'OC' a single number to Select, Underline, Print Styles, etc.**

● Automatic fanfold page margins. Puts gaps in listings. PRINTed text etc to skip the folds. The gap size alternates to minimise paper wastage when using binders.

● Form feed and related commands, made available on ALL printers. Can also provide a left margin.

● User defined characters embedded within text are printed as on VDU.

●★ Commands select option for GP100, STAR, NEC, MX/FX, LP VII/DMP100, DMP200. Operates with Parallel and Serial Printers.

● Fully functional with the popular WORDWISE wordprocessor.

Supplied complete with a comprehensive 50 page manual.

Price: £24

(When ordering, please specify printer type)

DUMPOUT 3

A highly sophisticated machine code ROM providing screen to printer dumps in any mode, plus window setting utilities and two new OSWORD calls that allow you to use the Beeb graphic coordinate system for plotting or testing mode 7 'pixels'.

*GIMAGE Ultra sophisticated dump of any graphic screen, using up to 8 tones. Handles **FULL MODE 7 text**, graphics, double-height and colour and mode 8. 14 optional parameters, using 'prefixing' so that you only need specify the ones that you want. The parameters include:

● V<scale>, H<scale>. These are both 2 byte numbers giving you very fine control over the dump size from minute to enormous. Unlike other dump Roms, scale does not vary with screen mode.

● R <0-3> Dump rotation 0, 90, 180, 270 degrees.

● I<indent> Set gap from left edge of paper.
● X <min> <max>, Y <min> <max>. The area of the screen dumped is that in the graphics window, alternatively these parameters may be given.

● P Physical colour values used for dumping. (Otherwise use a negative scale, i.e. white prints darkest.)

● T Two tone dumps for higher resolution.
● M <mask> 8 bits controlling colour masking.
● E Contrast expansion. Makes mode 7 text characters and separated graphics stand out more clearly from the background.

● C All mode 7 graphics printed as reduced size dumps.

● *GWINDOW Draws graphic window on screen, its size and position can then be altered using the cursor keys.

● *TIMAGE <indent> Does a fast, text only dump of the text window in any mode.

● *TWINDOW As GWINDOW but for text. DUMP OUT 3 gives you ALL of the GIMAGE facilities listed above and GWINDOW in mode 7 as well, not just hi-res modes.

Ideal for CP80, GP80, DP100, GP250, STAR, KAGA/TAXAN, NEC, SHINWA, CP80, GEMINI, EPSON MX/RX/FX, LPVII, DMP100/120/200/400 Printers. Comprehensive Manual included. **Only £22**

APPROVED for use with telecommunication systems run by British Telecommunications in accordance with the conditions in the instructions for use.

Watford Electronics

MODEM 84

For BBC Microcomputer

With the launch of Watford's MODEM 84 you can now hook into PRESTEL, MICRONET, HOMELINK, TELECOM GOLD, etc., for about the cost of a good tape recorder. Prestel gives you access to an incomparable database covering almost every subject under the Sun. There is Micronet with lots of free programs that you can download and run. Details of Clubs and User groups, a diary of meetings and exhibitions, news and reviews, technical information, etc. There is Homelink with On-line banking. And there is armchair shopping, travel information, Entertainment, World News, Sports News, Business News, Weather information, Electronic mail and lots more. The basic Prestel subscription is only £5 per quarter for domestic user and at off-peak times there is no charge for access time. Can you afford not to be part of this revolution?

Now using the latest techniques and the new generation of Modem chips, Watford have developed a Modem that is newer, better and yet cheaper than any on the market.

Compare the Specifications:

MODEM

● Direct-connect Modem using BT approved isolation components.

● Full Duplex V23 operation for Prestel and TELECOM GOLD operation (1200/75 Baud).

● User-to-User half duplex 1200/1200 Baud operation with AUTOMATIC SEND/RECEIVE switch (BEWARE - most MODEMS switch manually between send and receive, which precludes the use of intelligent user-to-user software).

● Simple single button operation and comprehensive LED status display.

● Attractively finished. Sized to sit on the Disc drive.

FX80 PRINTER DRIVER for VIEW

Do you want to use Italics or Enlarged Characters with View? French or German Characters? These and other FONTS from FX80 character sets can be accessed using our Printer Driver with VIEW. The disc contains an example as well shows how to use. Available on 40 or 80 track Disc. **ONLY: £9**

EPSON DUMP ROM

A specially designed Dump ROM for EPSON RX, FX and the new Kaga KP810 Printers. Will accurately DUMP all Screen modes including TELETEXT, GRAPHICS and DOUBLE HEIGHT. MULTITONE DUMPS are also supported. Simple single command (*SCDUMP) operation. **Only: £20**



NEW SUPER PRESTEL INTERFACE ROM

Fully compatible with Watford's MODEM 84 as well as with PRISM and most other Modems.

● Supports full Prestel Colour Alpha and Graphic Characters including Double Height, Flashing, Conceal/Reveal.

● Called by simple *PRESTEL command. Disc and Tape configurations fully supported.

● Telesoftware downloader included.

● Comprehensive MAILBOX facilities including offline editor.

● Auto Logon sequence, can be burnt into ROM if desired.

● Unique "TAG" facility allows tagging and recall of interesting pages - avoids the common and annoying 'NOW WHERE WAS THAT PAGE' problem.

● Page load and save to tape or disc. Pages are automatically saved under Page Number reference in a 'FRAME' directory.

● Print page options are ASCII only (i.e. with suppression of Graphics) - fast and works with any printer - as well as a full graphics dump for the popular Epson printer.

● 'USER' function call built into interface with specialist add-on routines (your own as well as ours).

● All the above facilities available from Function Keys. An overlay is provided giving simple yet comprehensive guidance to the key functions.

● Comprehensive instruction manual supplied.

PRICES:

SOFTWARE ROM incl. Comprehensive Manual £20

MODEM 84 (without software) £62

MODEM 84, SOFTWARE ROM and Operating Manuals ONLY: £82 (£2 carr.)

(Please allow upto 28 days for delivery)

Please write to Watford Electronics for full details, Order and Application Forms.

TINY PASCAL for BBC Micro £59

VIEW

Wordprocessor (New version) **£49**

FORTH ROM for BBC

This superb (FIG FORTH) compiling language now available in ROM. Simply plugs into one of the ROM Sockets. Manual included. **£33**

WATFORD ELECTRONICS

Continued →

WONDERFUL WATFORD

TWO DATABASE SOFTWARE for BBC MICRO

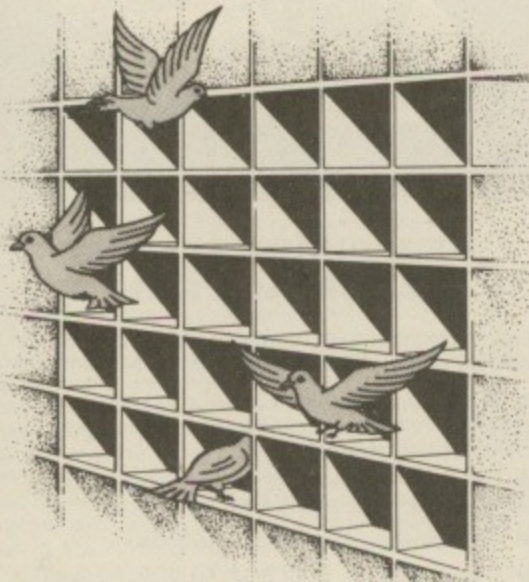

DISCDATA

At last for BBC Micro Disc users, Watford Electronics have produced 'DISCDATA' which must be the most versatile general database at the price on the market. The length of your files is restricted only by the space on your disc. You can have upto 20 fields with 'page' length records of upto 254 characters. The program is completely menu driven obviating reference to a manual although written guidance is given with the program. Add and delete records, amend title, field names and records, sort on any field and search for any record or group of records in any field. You do not need to abandon or rewrite your files if you wish to add additional fields or extend the length of any field, the program will rewrite the files for you. Your files can be in any drive. Output can be in 40, 80 or 132 character width with Printer routines. Two forms of output are provided for horizontal for label type output and a tabulated output with title and headings. What is more, the selected fields can be placed in any order on the screen. In the horizontal mode you can scan backwards or forwards with wrap around effect. Output can be started or stopped anywhere in the file. There is automatic totalling on decimal fields and an automatic count of the number of records output. Now with extra 3 features: Allows string search; Calculations can be done on numeric fields; Create Sub-Files from the main File.

On disc at **Only £17**
It has to be the best value.

FILE-PLUS

Now even more powerful with the added facility of a SHELL SORT on any field. This must make DATA-PLUS the most powerful and versatile Database to be found on BBC Micro. A 16K ROM containing the most flexible and easy to use disk based Database system on the market. A database may occupy your total on-line storage capacity. You may design any number of data entry forms using a "paint" on screen technique. Forms may be upto 3 screens in size. A form may be used to Add, Delete, Update, Print and Spool records from your Database. Quick search facility on any text field. A query language provides full maths support (-, +, /, *, +9999999999.9999) and compare facilities (=, >, <, <=, >=, &, !) when used with the keywords - Assign, Compare, Display, End, Goto, If, Ift, Print, Read, Search, Spool and Update. Full printed output control via embedded commands. Supplied with 70 page manual and fitting instructions.

Only £43

BUFFER & BACKUP ROM

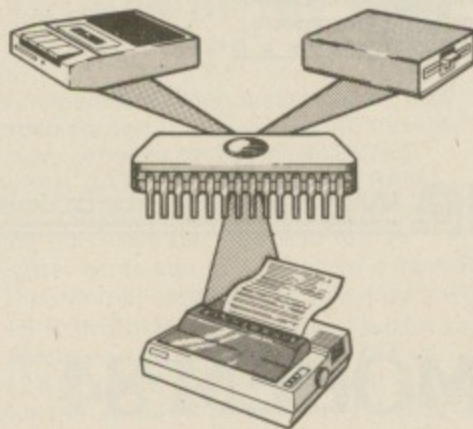

A very versatile firmware. An ideal ROM for engineers, programmers, teachers, students, etc.
 ★ Converts your Sideways RAM to a 4K or 16K BUFFER for a parallel printer. (Uses * FX5,3). (You no longer require to purchase expensive (£100+) Printer Buffers.)
 ★ Dumps selection of Disc files to Tape.
 ★ Makes backup copies of tapes onto Tape, Disc and Hobbit.
 ★ Displays contents of a chosen paged ROM on screen.
 ★ Menu display on 'shift-break' using ROM Filing System.
 ★ Comprehensive Manual
 Simply a give away at **£22**

GEMINI'S BUSINESS SOFTWARE

Cashbook Accounts	£52
Final Accounts	£52
Invoices & Statements	£17.25
Commercial Accounts	£17.25
Mailing List	£17.25
Database	£17.25
Stock Control	£17.25
Home Accounts	£17.25
Beebcalc Spreadsheet Analysis	£17.25
Beebplot	£17.25
Payroll	£39

N.B. All the above Gemini software is on tape. For Disc Based (40/80 track) please add £3.

PEN PAL-VERSATILE LIGHT PEN SOFTWARE

- Enjoy, Explore, Educate!
 - Pixil, Line, Character Definition
 - Free hand drawing
 - All Colours - MANY Special Effects
 - Fill, Refill and Stripes
 - User defined "Brushed Strokes" plus Character definer
 - Grid, Scale, Perspective aids
 - 2 TO 200 Points palletable in one Design with Circles and "RUBBER BANDING"
 - Move design/character to any screen position
 - Save and Load screens, User defined Graphics and line drawings for video titles, Own programmes, etc.
 - Many Educational uses
 - Instruction booklet included
 - Full software support for "CUSTOM USE"
 - Works with Watford, RH, Acorn User, DIY, and many other LIGHT PENS
 - Available on DISC or TAPE
- Price: Tape **£10**; Disc **£11**

DISC EXECUTOR

Disc Executor (our most popular software) is a highly sophisticated disc utility, which allows you to transfer all tape based software that we know of onto disc. You no longer have to throw away any of your cassette based software on acquiring a disc drive. It handles 'locked' programs and allows you to load full length adventure type programs (i.e. up to 6E blocks) and programs that load below &E00. It is very simple to operate (full instructions supplied). It saves you your valuable time and money too. Our Disc executor is not a Replica, its the 'Real Thing'. Available in both 40 and 80 track discs. Please specify when ordering.

Only: £10

ROM MANAGER

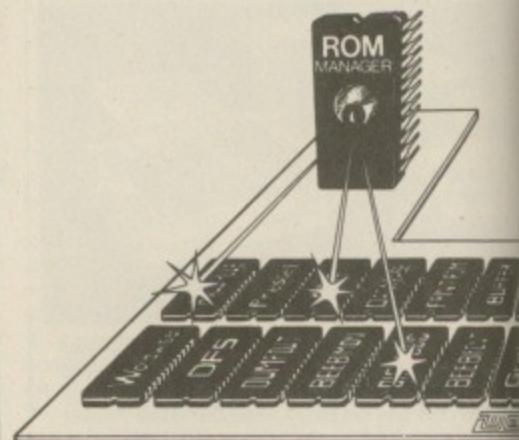

This unique piece of firmware has been designed to allow the USER to access the BBC Micro's Sideways Rom Paging facility to the full. The Commands our ROM MANAGER adds to your computer are concerned with 3 aspects of ROM use:

1. **ROM CONTROL** - Ability to activate at random any of the ROMs present in the Micro.
 2. **BBC MICRO'S STATUS** - e.g. Checksum any ROM, and the Filing system currently active.
 3. **ROM DEVELOPMENT** - Allows main memory to be used like Sideways RAM. The Commands available are:
 ***CHECKSUM** - generates a CRC for the specified ROM.
 ***DIRECT** - allows you to pass a particular command to the specified ROM.
 ***EXAMINE** - allows examination of the named ROM.
 ***EXPLAIN** - gives detailed description of the 22 FX codes.
 ***FILE** - passes the command directly to the currently selected filing system.
 ***FUNCTION** - displays the string currently programmed onto the function keys.
 ***INCLUDE** - allows the main memory to be used for developing ROM software without need to purchase expensive sideways RAM.
 ***MODIFY** - any location in memory is displayed and can be modified with this command.
 ***NAMES** - displays the names of any resident ROMs.
 ***RAM** - allows the command to be passed directly to the 'RAM based ROM'.
 ***REMOVE** - turns off the 'RAM based ROM' option.
 ***SPECIFY** and ***DEFAULT** - specifies the default ROM and passes the named command to the default ROM specified.
 ***STOP** and ***START** - allows the named ROM to be disabled or enabled, preventing clashes between ROMs.
 ***STATUS** - provides information about the ROMs inside the BBC micro, including the socket number, the name of the ROM, its length, whether or not it is enabled and supports language or service entry points.
 ***VALUES** - outputs information concerning the status of ROM MANAGER e.g. the socket number it occupies, the number of active ROM with a higher priority than itself, the current filing system.
 ***VECTOR** - the same function as ***DIRECT**, provided in case ***DIRECT** clashes with other ROMs.
- In our opinion this ROM is one of the most useful utility ROMs available on the market, and is a must for anyone using ROM based software.

Price: **Only £22**

ADE

The complete program development package on 16K ROM. A must for all the Assembly Language Programmers.

SPECIAL OFFER £49

ACCESS HOT LINE

Tel: 0923 50234

Watford's own
written by Andre
of the BBC

The most powerful
monitor ROM yet
all the normal
relocating facility
screen editor all
memory, entering
assembler menu
In use as a deb
a total emulation
urge to set a br
- you can even
writing location
contents. The s
of sideways RO
easily be run fr
there DFS and
used in total em
Beebmon can e
can nest Beeb
the memory siz
workspace, loca
on the 1MHz B
zero page work
BASIC) can use
How does it ac
interpreter all p
in a virtual BB
like the ROM la
by your progr
in Beebmon's v
allows immedia
level by ctrl-esc
being executed
power and flex
clear and detai
for money price

Disa

N 3
6

BEEB MON

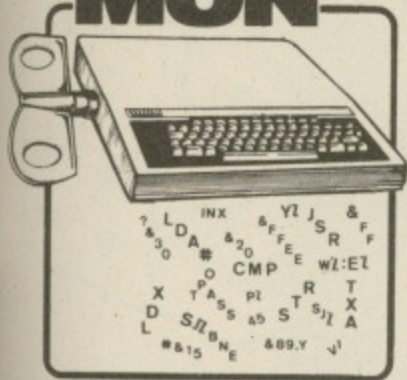

Watford's own Machine code Monitor ROM written by Andrew Bray (Cambridge), co-author of the BBC Micro Advance User Guide.

The most powerful and versatile machine code monitor ROM yet written for BBC Micro. It has all the normal memory editing, moving and relocating facilities, plus all editing is with a full screen editor allowing scrolling up and down memory, entering in Hex, ASCII or standard assembler mnemonics.

In use as a debugging tool, you run code under a total emulation system. Everfelt a desperate urge to set a break point in ROM? No problem - you can even have breakpoint on reading or writing locations in memory and on register contents. The system fully supports debugging of sideways ROMs e.g. BASIC can fully and easily be run from within Beebmon and from there DFS and other sideways ROMs can be used in total emulation mode.

Beebmon can even run itself. In so doing you can nest Beebmon up to a level limited only by the memory size. Beebmon uses 256 bytes of workspace, located anywhere in memory, even on the 1MHz Bus. Beebmon effectively uses no zero page workspace, so your program (e.g. BASIC) can use any or all of the base page. How does it achieve this? By providing a 6502 interpreter all programs running under it exist in a virtual BBC, so special memory locations like the ROM latch are not actually accessed by your programs, instead they alter a location in Beebmon's workspace. Emulation also allows immediate return to Beebmon command level by ctrl-escape no matter what code is being executed at the time. All this exceptional power and flexibility is complemented by a clear and detailed manual included in a value for money price of:

£22

Disassembler Rom

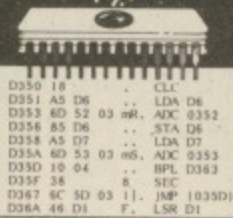
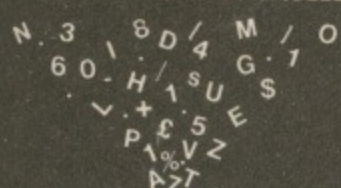

Discover the hidden secrets of BASIC and the OPERATING SYSTEM with this easy to use programmers tool.

A ROM based machine code Disassembler for the BBC micro. It enables machine code programs to be listed in BASIC/DUMP format and thus is the perfect complement to the built in assembler. It allows Sideways ROMs, files on disk or tape to be listed, and also has a comprehensive editor, allowing mnemonics to be altered directly, as well as HEX, DECIMAL, ASCII and BINARY memory editing. There is also a full set of labelling facilities available (up to 3,200 labels), with the major locations and routines already labelled.

Thus DIS-ASM enables any monitor program, such as BEEBMON to be used to much greater effect as it is not necessary to disassemble memory each time the display is altered.

ONLY £18

WATFORD - Always a step ahead

COMPUTER CONCEPT'S ROMS

CARETAKER Basic Utility	£28
Graphics ROM	£28
Disc Doctor ROM	£28

Wordwise

Without doubt a very sophisticated piece of software for the BBC Micro. It has all the features of a professional word processor yet is easy to use.

SPECIAL OFFER THIS MONTH: £32

THE INVESTIGATOR

Now you can make up back-up copies of all your Discs. Put the precious originals away in the safe and use your duplicates.

See what your 8271 can do! With Watford's Investigator you can find out about track formatting, sector length, etc. Investigate your disc and then make up your back-up copy.

Disc based software includes a comprehensive manual.

Price: £15

(Please specify 40 or 80 track when ordering)

LIGHT PEN for BBC Micro

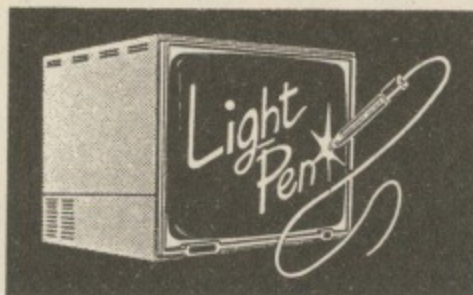

This versatile lightpen is very easy to use. It allows you free hand drawing in all colours. Has Special effects facility and many educational uses. An ideal and easy way of communicating with Micros for Children.

Only: £20

(Price includes our highly sophisticated PENPAL Lightpen software on Cassette. Please add £2 for software on Disc)

GAMES SOFTWARE

ADVENTURE QUEST (L.9)	£8.50
COLOSSAL ADVENTURE (L.9)	£8.65
CHESS	£6.95
CHUCKIE EGG	£7.90
CRAWLER (WESOFT)	£5.00
CROACKER	£6.95
DUNGEON ADVENTURE (L.9)	£8.50
Escape from MOONBASE ALPHA	£6.95
FELIX in the FACTORY	£6.95
GALACTIC COMMANDER	£6.95
KILLER GORILLA	£6.95
MUNCHYMAN	£5.95
MOONRAIDER	£6.95
MUSIC SYNTHESISER	£8.25
PENGO (Watford)	£6.95
SNOWBALL (L.9)	£8.50
SWOOP	£6.95
Twin Kingdom Valley	£8.25
747 FLIGHT SIMULATOR	£7.75

NEW LAUNCH

Watford Electronics' 32K RAM EXPANSION BOARD FOR THE BBC MICROCOMPUTER

Now Watford Electronics brings you the latest state-of-the-art memory expansion board for your BBC microcomputer. This compact board which fits inside the computer does not just give you 16K or even 20K of extra RAM, but a massive 32K!!!

There are many useful facilities available with this board:

- The top 20K of the expansion RAM can be used as the screen display memory, leaving all the standard BBC RAM free for programs or data storage. This allows good graphics and long programs to be combined. For instance you could have MODE 0/1/2 GRAPHICS AND 28K OF PROGRAM SPACE. The extra memory can be used by virtually any language or utility such as BASIC, VIEW, WORDWISE, etc.

- The full 32K or the bottom 12K of the expansion RAM can be used as a buffer for the printer, sound channels, RS423, keyboard or speech synthesiser. This allows very long text files to be printed while you are using 27K of program and 20K of graphics!

- This board is the ideal complement to any word processing system. There is no need to wait for slow printers as you can type in long text in 80 column display mode while printing is going on - TWO JOBS DONE SIMULTANEOUSLY!!! (an equivalent printer buffer would cost you £115+).

- The board is compatible with a vast range of software and hardware available for the BBC microcomputer, including our ROM expansion board and double density DFS.

- The board is extremely easy to fit. It is supplied complete with a comprehensive manual and ROM based software with full *HELP messages.

SPECIAL INTRODUCTORY OFFER

Only: £79 (carr. £1)

GRAPH PAD

With this popular British Micro's Graph-pad, you can add new dimension to your computer enjoyment. It helps you to create your own application programs by the simple use of the Graphpad. Ideal for Educational use. Supplied complete with Cables, Manual and a two program cassette.

Price: £115

SURGE PROTECTOR Plug

Safely eliminates dangerous voltage surges. During a thunderstorm, a nearby lightning strike can induce high voltage spikes in the voltage supply or fluctuating loads can also result in transient overvoltages which if unchecked, lead to expensive data corruption/loss. Our surge protection plug will provide the necessary surge protection. Simply replace your standard 13Amp mains plug with the surge protection plug (which is almost the same size). Ideal for computers, Hi-Fi systems, precision instruments, fridge freezers, etc. Max. surge current 2KAmp; Max. Voltage 250 Volts. A must for all serious computer users.

Price: £8.95

WATFORD ELECTRONICS

Continued →

BOOKS (No VAT on Books)

30 Programs - BBC Micro	£3.25
30 Hour BASIC (BBC Micro)	£6.95
35 Education Programs for BBC	£6.95
36 Challenging Games for BBC	£5.95
40 Educational Programs for BBC	£5.95
100 Programs for BBC Micro	£6.95
Cassette version of above	£10.00
6502 Application Book	£11.95
6502 Assembly Language Program ..	£13.95
6502 Assembly Language Subroutines	£14.25
6502 Machine Code for Beginners	£5.95
6502 Software Design	£10.50
A young persons guide to BBC Basic ...	£4.50
Advanced Machine Code Technique for BBC	£7.95
Advanced User Guide for BBC Micro	£11.95
Advanced Graphics with BBC	£9.95
Advanced 6502 Interfacing	£10.95
Advanced 6502 Programming	£12.45
Assembly Language Programming on BBC Micro	£7.95
Advanced Programming Techniques for the BBC Micro	£7.95
BBC Basic	£7.95
Assembly Lang. Prog. on BBC	£7.40
BBC BASIC	£5.95
BBC Basic for Beginners	£6.95
BBC DIY Robotics & Sensors	£6.95
BBC Forth	£7.50
BBC Lisp	£7.50
BBC Micro An Expert Guide	£6.95
BBC Micro Book BASIC Sound & Graphics	£7.95
BBC Micro Graphics and Sound	£6.95
BBC Micro Programs in Basic	£5.95
BBC Micro ROM PAGING System Explained	£2.50
BBC Micro Revealed	£6.95
BBC Micro Assembly Lang. Prog.	£7.95
BBC Micro Disc Companion	£7.95
BBC Micro in Education	£6.50
Basic Programming on BBC Micro	£5.95
Best of PCW Software (BBC)	£5.95
CP/M Users Guide	£13.95
Creating Adventure Programs on BBC Micros	£6.95
Creative Graphics Cassette (Acornsoft). Has 36 graphics programs	£8.95
Creative graphics on BBC Micro	£7.50
Complete Programmer for BBC	£5.95
DISC FILING SYSTEM (DFS) Operating Manual for BBC	£7.50
Discover BBC Machine Code	£6.95
Discover FORTH	£13.95
DIY Robotics & Sensors with BBC	£6.95
Further Prog. for BBC Micro	£5.95
FORTH Programming	£14.40
Functional Forth for the BBC Micro	£5.95
Games on your BBC Micro	£2.95
Games BBC Computer Can Play	£6.95
Graphs & Charts on BBC Micro	£7.50
Graphic Art for BBC Computer	£5.95
Graphs and Charts (Cassette)	£7.50
Graphics on BBC Micro	£6.95
Hobbit (Book and Cassette)	£14.95
Introducing the BBC Micro	£5.95
Introduction to FORTH	£9.30
Intro to Micro Beginners Book (3 Ed.)	£9.90
Let your BBC teach you to program	£6.45
LISP	£9.25
Logo Programming	£8.95
Mastering VISICALC	£12.45
Mastering CP/M	£13.65
Micros in the Classroom	£4.90
Programming the 6502	£11.95
Programming & Interfacing 6502	£16.00
Programming the BBC Micro	£6.95
PASCAL	£9.25
Programming for Education on BBC ...	£5.95
Structured Prog. with BBC BASIC	£6.50
The Complete FORTH	£6.95
The BBC Micro Book, BASIC, SOUND & GRAPHICS	£7.40
Using Floppy Discs with BBC Micro	£5.95
Using BBC Basic	£6.95
Using 6502 Ass. Language	£14.50
Wordstar & CP/M made easy	£6.95

DOUBLE DENSITY BOARD

We are proud to announce the launch of our Double Density Board for the BBC Micro. The DDFS software that we supply is a version of our highly acclaimed standard 16K DFS for the BBC Micro. It has all the features of the single density DFS. Allows single files upto 359K. It will automatically tell whether a single or double density disc is being accessed, as well as allowing the option of reading 40 track disc on an 80 track drive. Now on your 80 track Double Sided Drive you will have 720K storage instead of the usual 400K and with higher speed than ever before (of course this is a BONUS at NO EXTRA COST). Complete Double Density Upgrade Unit will cost same as single density Kit.

Delivery 4 weeks (approx)

DATA RECORDER & ACCESSORIES

Top quality Slimline, portable Data Recorder for computer use. Mains/Battery, operated with counter **£22.00**
DATA RECORDER CABLE For our Data Recorder to BBC Micro **£2.50**
DATA CASSETTES Top grade C12 Data Cassettes in library cases. **36p**

ATTACHE CARRYING CASE for BBC Micro

These Attache Carrying cases are attractively finished in mottled antique brown leatherette. An ideal and very safe way to carry your BBC Microcomputer. Price: **£12 (£2 carr.)**

This space reserved for our 'Launch of the Year' Hardware

This space reserved - to be unveiled at for yet another the Acorn User launch of our Show OLYMPIA - Hardware for the LONDON. August BBC 1984. Microcomputer.

VOLTMACE'S DELTA 14 Hand-set

Price: 'Delta 14' Hand set **£12.50**
 ADAPTOR MODULE **£12.55**
 TRANSFER PROGRAM **Tape £5.10**
 Disc **£7.95**

JOYSTICKS for BEEB

Two versions available:
SINGLE: Player type £7.00 each
TWO Players type £12.00 per pair

Prices subject to change without notice and availability.

MAIL ORDER AND RETAIL SHOP. TRADE AND EXPORT INQUIRIES WELCOME. GOVERNMENT AND EDUCATIONAL ESTABLISHMENTS OFFICIAL ORDERS ACCEPTED. CARRIAGE: Unless stated otherwise, please add 75p to all cash orders.

VAT: UK customers please add 15% VAT to the total cost incl. Carriage.

SHOP HOURS: 9.00am to 6.00pm. Monday to Saturday. (Ample Free Car Parking Spaces) ACCESS ORDERS: Simply phone: Watford (0923) 50234. (24 Hours)

PLINTH FOR BBC MICRO

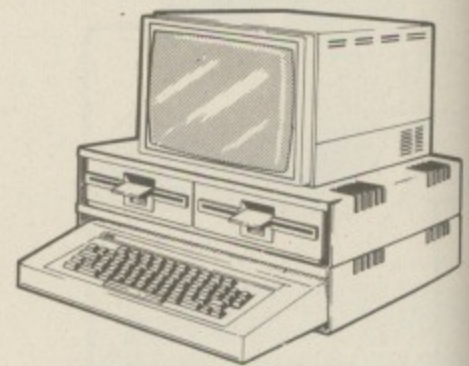

Protect your micro from the weight of the heavy TV/Monitor. This sturdy plinth is attractively finished in BBC colour. Air vent slots have been provided to allow maximum air circulation. It can be used to support a monitor or a printer. The micro slides underneath comfortably. A must for every BBC Micro owner, specially for those who have to move/open their computer frequently.

Single Decker **£11 (carr. £1.50)**
 Double Decker **£20 (carr. £2.00)**

PLINTH FOR PRINTERS

Keeps your desk tidy. Place the printer on the plinth and the paper underneath. Finished in BBC colour.

£10 (carr. £1.50)

4 WAY MAINS DISTRIBUTION SOCKET

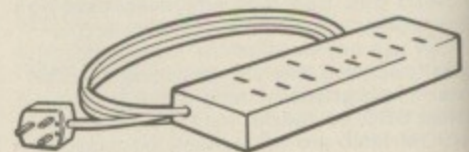

A highly versatile space saving solution when multi-power outlets are required. Can be wall or floor mounted. Ideal for Micro Computer and peripherals application. Prevents you getting a dangerous tangle of plugs and adapters. Only: **£9.50**

READY-MADE LEADS

CASSETTE LEADS 7 pin DIN Plug to 5 pin DIN Plug + 1 Jack Plug **£2.00**
 to 3 pin DIN Plug + 1 Jack Plug **£2.00**
 to 7 pin DIN Plug **£2.50**
 to 3 Jack Plugs **£2.00**
6 pin DIN to 6 pin DIN Plug (RGB) Monitor Lead, BNC to PHONO £2.50
 Disc Drive to BBC Micro Power Lead **£3.00**
 Single: **£3.00** Dual **£3.75**

MISCELLANEOUS CONNECTORS

	Plugs	Sockets
RGB (6 PIN DIN)	30p	45p
RS423 (5 pin Domino)	40p	50p
Cassette (7 pin DIN)	25p	65p
ECONET (5 pin DIN)	20p	30p
Paddles (15 pin 'D')	110p	215p
BBC Power Plug 6 way	80p	-
Disc Drive Plug 4 way	75p	-

Watford Electronics
 Dept. BBC, Cardiff Road, Watford, Herts, England
 Telephone: 0923 40588/37774. Telex: 8956095

MICRO



t of the heavy
tractively
ts have been
ulation. It can
printer. The
y. A must for
or those who
requently.

1 (carr. £1.50)
0 (carr. £2.00)

ITERS

er on the
nished in

(carr. £1.50)

CKET



n when
be wall or
ter and
getting a
ters.

ly: £9.50

ADS

£2.00
£2.00
£2.50
£2.00
£2.50
£3.00

GB)

ad

JS

Sockets
45p
50p
65p
30p
215p

COME.
EPTED.

(paces)

ics

gland.
6095



HIGH RESOLUTION THAT COMES HIGHLY RECOMMENDED.

"There is no doubt that the JVC range of ECM colour monitors is excellent value for money . . . there is no loss in quality of picture after long periods . . . and remember, as more and more resolution is available with new micros, the need for a better display will be that much greater."

High recommendation indeed from Personal Computer News. Meanwhile Acorn User said:

"It seems that all 'normal' and 'medium' resolution monitors, including the Sanyo, are simply inadequate to deal with the Beeb's graphics and text output . . . The JVC was excellent, giving clear, legible results . . . Was the JVC better than the Microvitec?* Would I buy one? Yes to both questions."

Our RGB high resolution colour monitor (580 x 470 pixels) sells for £229.95 (excluding VAT) – that's a saving of over £100 compared with other leading monitors of similar specifications.

The unit has a 14" screen and is suitable for the BBC Micro, Electron, Sinclair QL, Lynx, Oric, Apple, IBM and most other leading micros.

MODEL REFERENCE	1302-2 High Resolution
RESOLUTION	580 x 470 Pixels
CRT	14"
SUPPLY	220/240v. 50/60Hz.
EHT	Minimum 19.5kv Maximum 22.5kv
VIDEO BAND WIDTH	10MHz.
DISPLAY	80 characters by 25 lines
DOT PITCH	0.41mm
INPUT: VIDEO	R.G.B. Analogue/TTL Input
SYNC	Separate Sync on R.G.B. Positive or Negative
EXTERNAL CONTROLS	On/off switch and brightness control

And naturally there's a year's full guarantee.

If you order your monitor by post, you'll receive it within ten days by courier service.

Simply post the coupon below to: Opus Supplies Ltd., 158 Camberwell Road, London SE5 0EE. Or telephone 01-701 8668 quoting your credit card number. Or, of course, you can buy at our showroom between 9.00–6.00pm, Monday–Friday 9.00–1.30pm, Saturday.

*Microvitec Cub 14" monitor.

To: Opus Supplies Ltd., 158 Camberwell Road, London SE5 0EE.
Please send me:

- _____ High Resolution Colour Monitor(s) at £229.95 each (ex. VAT).
- _____ Medium Resolution Colour Monitor(s) at £179.95 each (ex. VAT).
- _____ Connection lead(s) at £6.00 each.

I understand carriage per monitor will cost an extra £7.00. (N.B.A High Resolution Monitor including VAT, lead, and carriage costs £279.39. A Medium Resolution Monitor including VAT, lead and carriage costs £221.89).

I enclose a cheque for £_____ Or please debit my credit card account with the amount of £_____. My Access/Barclaycard

(please tick) no. is _____

Please state the make of your computer _____

Name _____

Address _____

Telephone _____

Opus.
Opus Supplies Ltd.

BU27

THE EXPERTS

EXPORT

SCI(UK) SETTING NEW STANDARDS IN CUSTOMER SERVICE



ORDER TODAY - PRINT TOMORROW! 24 HOUR DELIVERY

ORDER TODAY - PRINT TOMORROW! 24 HOUR DELIVERY



0730 68521 ANY DAY INCLUDING SUNDAY

EPSON LOW PRICE SPECIALS FROM £199

7 DAYS A WEEK

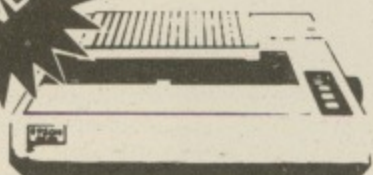

EPSON RX80 (DOT MATRIX)	£249	£199	+ VAT = £228.85
EPSON RX80FT (DOT MATRIX)	£285	£239	+ VAT = £274.85
EPSON FX80 (DOT MATRIX)	£438	£324	+ VAT = £372.60
EPSON MX100 (DOT MATRIX)	£475	£365	+ VAT = £419.75
EPSON RX100 (DOT MATRIX)	£450	£385	+ VAT = £442.75
EPSON FX100 (DOT MATRIX)	£569	£499	+ VAT = £573.85

NEW! Canon PW-1080A £269.00

+ VAT = £309.35

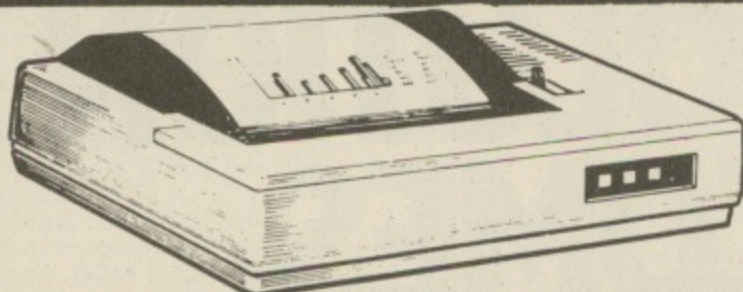

80 cols; High speed printing, 160 CPS; bi-directional logic seeking; fantastic 27 CPS near letter quality; 23 x 18 matrix; very quiet - less than 60 dB; 4, 5, 6, 8 10, 12, 17 CPI; down loading for user-optional characters; high resolution graphics; handles various forms, roll paper, fan fold, single sheet and multipart copy paper.

ALSO AVAILABLE THE CANON PW1156A as above but 156 cols **£369.00** + VAT = £424.35

PHONE 0730 68521 INCLUDING SUNDAY!

JUKI 6100 just **£349** + VAT = £401.35

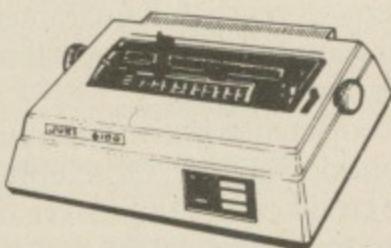

20CPS: Bidirectional & Logic 10, 12, 15 & Proportional Spacing; Wordstar compatible 2K Buffer; 13 inch Platen Underline; backspace & lots more Centronics Interface Standard

OPTIONAL RS232 TRACTOR AND SHEET FEEDER

SHINWA CP80 **£179.00** + VAT = £205.58

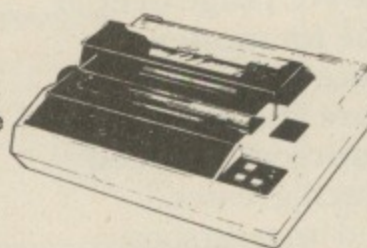

Friction and tractor feed as standard. 80cps. Bi-directional logic seeking 13 x 9 dot matrix giving true descenders, sub and superscripts Italic printing and auto underlining Condensed, emphasised, expanded and double strike (can be mixed in a line). Parallel interface fitted as standard

WE WILL MATCH ANY GENUINE PRICE ADVERTISED SCI(UK) IS NEVER BEATEN ON PRICE

MANY MORE PRINTERS AVAILABLE 1,000s OF BARGAINS SEND NOW FOR THE FAMOUS SCI(UK) CATALOGUE



FIDELITY 14" COLOUR MONITOR & COMPOSITE VIDEO



£189.00 + VAT = £217.35

We have interfaces and cables for all types of computers, including CMB 64, Vic 20, APPLE, TRS 80, IBM, BBC, SPECTRUM, DRAGON, TANDY, SINCLAIR, APRICOT, SIRIUS, MONOTECH, QL, ADVANCE, TEXAS ETC



24 hour nationwide delivery by Securicor £9.50 + vat. Bankers Orders; Building Society Cheques; Postal Orders; - same day despatch. All orders covered by the Mail Order Protection Scheme. Nationwide maintenance contracts arranged. Educational discounts very welcome.

SCI(UK)
0730 68521

FREEPOST PETERSFIELD HANTS GU32 2BR
TELEX 86626 MYNEWS G

DEALER ENQUIRIES WELCOME WRITE FOR DETAILS

TRADE

CALLERS WELCOME SEVEN DAYS A WEEK TO OUR SHOWROOM AT 12 HIGH ST., PETERSFIELD, HANTS

URGENT ORDER PLEASE RUSH ME

SC(UK) FREE POST PETERSFIELD, HANTS GU32 2BR

Name _____ Address _____ Credit Card _____ Number _____

HAVE a look at Program I – you should see that it's nearly identical to last month's Program IV with one important alteration – all the variables are real variables rather than integer variables. That is, I've left off the % signs.

```
10 REM *** PROGRAM I ***
20 MODE 6
30 VDU 14
40 INPUT "Maximum Number", max
50 DIM square(max),cube(max)
60 FOR loop = 0 TO max
70 square(loop)=loop*loop
80 cube(loop)=loop*loop*loop
90 NEXT loop
100 FOR loop=0 TO max
110 PRINT loop,
square(loop),cube(loop)
120 NEXT loop
130 VDU 15
```

If you saved Program IV, as I suggested last month, all you have to do is some nifty work with the copy key.

However, the change from integer to real means a lot more to the micro than just a missing character. You see, the micro remembers, or stores, real variables in a different way to integer variables.

In fact, it takes up more memory in storing a real variable than it does when storing an integer.

This isn't surprising, since real variables have to remember all the fiddly decimal bits, as well as the whole part of the number.

The way we measure memory is in bytes – as a rule of thumb, you can store one letter in one byte of memory. So ABCD would take up four bytes just for its own characters.

Numbers are a special case – I'll spare you the grim details. Unlike strings, where the number of bytes you need depends on the number of characters in the string, each number is stored in a fixed amount of bytes.

Integer variables take up four bytes each. Mind you, there's only so much you can cram in there.

As we found last month, there's an upper limit – though at 2,147 million I

Accuracy, memory or speed?

don't think we can complain much.

Reals, however, take five bytes each, using what's known as floating point notation.

Basically, what they try to do is remember as many of the digits in the number as possible, using four bytes – almost like in integers.

The fifth byte stores the exponent – that is how many tens you multiply by – needed to change the four digits into approximately the number you wish. This is very similar to the 1E9 notation we saw last month.

Notice the word approximately – this method does its best, but it cannot guarantee accuracy. After all, you've only got one more byte to remember things in than you had with the integers, and yet you're trying to cover bigger numbers and still include decimals.

To see what I mean try:

```
A=1.5555555555555555
PRINT A
```

You should get 1.55555556.

Okay, so it's not spot on... but the error is well below a millionth.

Don't become complacent about this high level of accuracy – nobody enjoys receiving a gas bill for £63.99999999!

Run Program I and enter 1000. You should get the same results as you did last month when you ran Program IV. (If you didn't save it, and want to check, I've listed it again as Program II.)

```
10 REM *** PROGRAM II ***
20 MODE 6
30 VDU 14
40 INPUT "Maximum number", max%
50 DIM square%(max%),cube%(max%)
60 FOR loop%=0 TO max%
70 square%(loop%)=loop%*loop%
80 cube%(loop%)=loop%*loop%*loop%
90 NEXT loop%
100 FOR loop%=0 TO max%
110 PRINT loop%, square%(loop%),
cube%(loop%)
120 NEXT loop%
130 VDU 15
```

Try running both programs entering 2500 as the maximum – use 2000 if you have a DFS.

On Program I, which uses real variables, you'll get the error message:

DIM space at line 50

whereas Program II, which uses integers, will give you:

Too big at line 80

The point is, when you DIM a numeric variable array, the micro is bright enough to work out how much memory you need in total – since it knows how many bytes each variable in the array will take.

If you haven't got enough room you

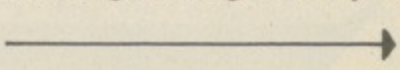

SYSTEM SOFTWARE

ROMs FOR THE BBC MICROCOMPUTER

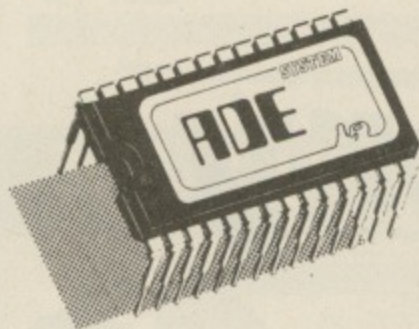

The complete program development package for assembly language programmers. ADE is the de facto industry standard for professional software writers using the BBC microcomputer. The 16k ROM contains a full 6502 MACRO assembler; a dynamic text editor; a front panel debugging monitor and disassembler. ADE comes complete with a 160 page comprehensive reference manual and a utility/macro library disc. ADE can also be used with tape based machines.

The ASSEMBLER features macros with library facilities; nestable conditional assembly; flexible listing options (with or without macro expansion); hex, decimal, binary and ASCII data formats; dummy section; full range of arithmetic and logical operators; symbol table sort and dump; file chaining and 29 powerful pseudo ops. Source and object files are kept on disc so there is no limit on program size or location.

The EDITOR is designed with the programmer in mind for writing both programs and documentation. The editor includes a very powerful command language (including macros) that enables much editing to be done on a semi-automatic basis. It features full screen editing and deferred edit modes; no limit to document size; edit with backup facilities and a versatile text formatter.

The DEBUGGER is instantly accessible for inspecting, modifying and disassembling machine code programs. Features include full 64 byte display in hex, ASCII and disassembled format; registers; stack; single step; breakpoints; memory search and much more.

Price £60 inc vat. Please specify 40 or 80T utility disc.

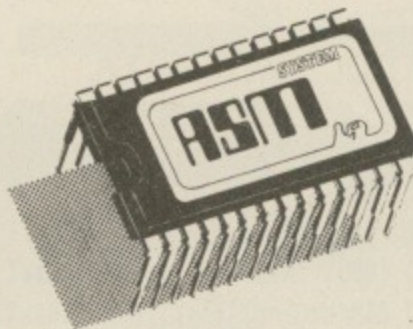

ASM provides all the superb features of the ADE macro assembler on its own ROM.

The program source file may be written using any editor (even Wordwise or View!). Complete with reference manual and utility/macro library disc. Use the assembler that professional software writers use.

Price £35 inc vat. Please specify 40 or 80T utility disc.

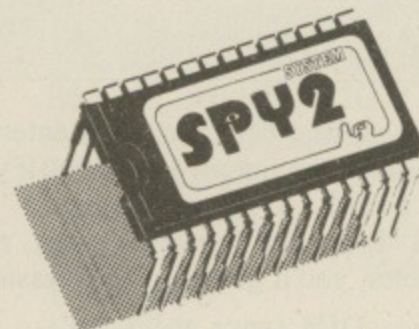

SPY2 is a front panel debugging monitor, disassembler and disc utility ROM. SPY2 is instantly accessible to the programmer for inspecting, modifying, debugging and disassembling machine code programs. SPY2 also features a relocater and program trace facilities. SPY2 will access any ROM either in the sideways ROM sockets or on an extension board. ROM memory may be displayed, single-stepped through or disassembled.

SPY2 includes a set of powerful disc recovery commands for interrogating, editing and retrieving data stored on a floppy disc. SPY2 also includes a disc formatter as well as a non-destructive single track reformatter.

In all SPY2 has a comprehensive set of 23 utility commands. These are supported by an excellent Reference Manual.

The SPY2 front panel encompasses all the superb, easy-to-use facilities of the renowned SPY debugging monitor PLUS additional commands for toggling and finding breakpoints; relocating machine code programs; single stepping through subroutines in one go and facilities for accessing the front panel from programs in RAM or ROM with breakpoints, OSBYTE or CTR-F.

SPY2 features a versatile disassembler with hex dump, full and intelligent disassembly. This identifies data areas in the program; these being displayed as a hex/ASCII dump. Operating system calls are labelled creating very readable code. The powerful trace facilities enable program instructions and register contents to be traced to printer whilst the program is running. Indispensable for graphics programs as they can be stepped through whilst observing the effects on the screen.

SPY2 features a disc sector editor displaying the contents of a whole sector; disc search facilities for finding byte patterns or strings and free disc space. Files may be recovered by creating a directory entry with all the data concerning the deleted file. Directory entries can be easily amended using the *AMEND command. The *FORMAT command formats discs with any number of tracks. A verify command checks discs. The *REFORMAT command is extremely useful for recovering information from a bad track, reformatting it and restoring the data. Commands are included for loading files at 81900 and automatically downloading (and running) them.

The most comprehensive of all debugging/disc utility ROMs.

Price £30 inc vat.

SYSTEM

Dept. B 12 Collegiate Crescent, Sheffield S10 2BA



From P

get the D
Now is
byte less
with dif
enough
variables.
limitation
variables
message.

The rea
rather tha
have a D
micro's r

Since
means t
earlier.

This r
DFS is
"downloa
means yo
the micro
back the

If you
Mode or
four on y
July 198
the rem

To re
integers,
or eleme
DIM spa

Howe
aren't th
and int
integers
doing su

To sh
rather fa
III:

10
20
30
40
50
60

TIM
Micro in
of a sec

When
TIME is
every h

You
by assign
variable

on incre
a second

This
Program
Line

From Page 45

get the DIM space error message.

Now integer variables take up one byte less memory each, so you get away with dimensioning, or allocating, enough memory for your 2500 variables. However you fall foul of the limitations on the size of numeric variables and so get the "Too big" message.

The reason I suggested 2000 for discs rather than 2500 is because, when you have a DFS fitted, it grabs some of your micro's memory.

Since there's less memory left, it means the above "effects" happen earlier.

This memory stealing habit of the DFS is why many programs need "downloading" in order to run. This means you load the program in, then tell the micro the DFS isn't there and steal back the memory!

If you have a DFS and get a Bad Mode or DIM space message, it's six to four on you need a downloader. See the July 1984 issue of *The Micro User* for the remedy.

To return to the subject, even with integers, if you want too many variables or elements in your array you'll get a DIM space message.

However, accuracy and memory size aren't the only differences between real and integer numerics. The fact is, integers are far quicker than reals at doing sums.

To show this, we'll need to take a rather fascinating detour. Try Program III:

```
10 REM *** PROGRAM III ***
20 MODE 6
30 TIME=0
40 REPEAT
50 UNTIL TIME=500
60 VDU 7
```

TIME is a variable that the BBC Micro increases by one every hundredth of a second.

When you switch on the micro, TIME is at zero, but it increases by one every hundredth of a second.

You can change the value of TIME by assigning it a value, as you would a variable, but as soon as you do it keeps on increasing by one every hundredth of a second!

This is exactly what we do in Program III.

Line 30 sets TIME to zero and then

lines 40 and 50 patiently repeat doing nothing at all until TIME equals 500. You then drop out of the bottom of the loop.

Line 60 then does a VDU 7 which causes the micro to beep.

The whole thing should take about five seconds – at least to the accuracy

'..integers are far quicker than reals at doing sums'

with which you'll be able to press your stopwatch!

To prove that TIME really is varying, add:

45 PRINT TIME

Sometimes, however, although you want to time something, you don't want to fiddle with the actual value of TIME – you may be already using it to time something else, for instance.

This is no problem. All you have to do is store the value of TIME in a variable at the start of the timing period, then keep on checking until TIME has increased past the old, stored value of TIME plus the period you're timing.

In Program IV we save the value of TIME with:

30 time% = TIME

We repeat until TIME is more than 500 greater than this same value, as in line 50:

50 UNTIL TIME - time% > 500

The whole thing does exactly the same as Program III without interfering with the actual value of TIME which is

still ticking away in the micro, increasing by one every hundredth of a second.

To show the difference, add:

45 PRINT TIME

and run the program.

To return to our discussion of Programs I and II, and the differences between numeric and integer variables. TIME allows us to time the difference in speed between Program I, with its integer variables, and Program II, with its numeric variables.

We'll need to make some alterations. Lines 30 and 130 will have to go – after all, we don't want to time the micro waiting for us to press Shift!

Next add the following lines:

55 TIME = 0

and:

130 PRINT "Time taken was "; TIME/100;
" seconds."

These amendments should let us know how long it takes to calculate and print out the squares and cubes.

Try a maximum of 100 with both programs and you should find that integers are faster than numerics – though not by much. In my case, it was four seconds for integers as opposed to 4.38 for the reals.

When you think about it, though, we're not just timing the calculations, we're also timing how long it took to put them on the screen.

To make it fairer, let's get rid of the printing-out loop, lines 100-120, in both programs, with:

DELETE 100,120

If you now run both for a maximum of 100, you'll see how much time was taken up simply printing things out! Also you'll see that the integer variables are far faster than the reals.

My times were 0.54 seconds for the integer and 0.88 seconds for the real – a saving of about 40 per cent.

So if you've got a lot of calculations, and don't need decimal accuracy – use integer variables.

Incidentally, if you get other values, don't worry. If you use a second processor, for instance, the times drop to 0.36 for integers and 0.59 for reals.

Well that's all for this month... Next month it's time for something completely different!

B-BASE: £25—8 Great Features

WHAT IS A DATABASE?

It is a FILE which contains RECORDS. Records consist of a number of FIELDS containing the information—an analogy can be drawn with a card index in which a box of cards is the file. Each card is a record and each line on the card is a field.

SPECIFICATION

- 1) Random Access—disc based, single or dual drives
- 2) File Size—99K (40 track), 199K (80 track)—65,000+ records
- 3) Record Size—up to 2048 characters and 200 fields
- 4) Field Size—up to 254 characters with complete line scanning
- 5) Access any record using Primary Key in 2 seconds
- 6) Holds—1200 NAMES AND ADDRESS records on 100K disk
- 7) Search—500 records on 5 fields in 60 seconds
- 8) Sort—500 records on 3 fields in 60 seconds

SYSTEM FEATURES

SEARCH PARAMETERS =, <, >, >=, <=, <>, INSTR
CALCULATE—Global or local totals and functions using any valid BBC expression
POWERFUL PRINTOUT OPTION—Eliminates need for separate mailing program, Parallel/Serial Printout allows setting of printer control codes, line spacing, tabulation, Headings etc, plus label printing with horizontal and vertical tab control.
REDEFINE—Titles, field widths, number of fields etc.
TRANSFER—Records from one file to another
SEARCH LISTS—Allow creation of sub-Databases within main Database but without having to save data again.
DATE FORMATS—6 formats for printout
All timings and sizes are relative to ACORN DFS. Compatible with ACORN DFS, WATFORD 1.3 and latest AMCOM DFS.

All Disc Software now available on 3" disc—add £3 to printed prices

Send S.A.E. for detailed data sheet

REPLICA II: £12.00.

The original REPLICA set a very high standard so the specification we set our chief programmer included some impossible features. In fact ACORN state that some of the things that we have done are impossible, it just took us longer that's all. REPLICA II transfers most cassette based programs to disk, even more than REPLICA. When you buy disk drives you do not have to throw away expensive cassette based programs.

REPLICA II transfers 'LOCKED' programs, programs loading as files, programs that load below &EOO, those with up to 6 sections and those up to &6E in length eg adventure programs. No waiting for 6 minutes whilst adventure programs load.

REPLICA II is very easy to use. The user enters a name, how many sections and whether CHAIN, RUN or LOAD to load the first section. Press play and let the program do the rest, even a menu. Think how much it will cost you to buy just 1 disk version of your favourite program—REPLICA II which will hold up to 16 programs, limited only by the disc capacity.

CLARES NO1 IN UTILITY SOFTWARE!

BEEBSYNTH: disk £11.00 cassette £8.00

A very powerful, easy to use sound generating program for expert and novice. Up to 16 envelopes can be defined and saved. The envelope definer is easy to use, control is through the cursor keys and the effects of changes can be heard immediately. When you have defined your envelopes press 'K' for Keyboard and the keyboard is transformed into a musical instrument, but you control which instrument. Plays chords, not just single notes, change pitch and duration etc. A superb program that you can use immediately. Unlimited sounds at your disposal. Recommended by MICRO USER, PCN, HCW etc.

GRAFKEY/GRAFDISK: disk £12.95 cassette £9.00

The 'GRAF' series of programs are, to our knowledge, the cheapest entry to the CAD (Computer Aided Design) field on the BBC micro. Input is either joystick or keyboard. All graphics modes can be used and altered whilst running, the functions provided are: Line, rectangle, triangle, circle, text (upper and lower case), paint and colour pallet (8 colours and flashing). Drawing aids include:

Alignment grid, circle copy, delete, free memory, purge memory, variable cursor speed, clear screen and redraw. Save drawings to tape in about 20 seconds or to disk in about 2 seconds.

Rubber Band is a very flexible line drawing facility. Pictures can be saved and included in your own programs, very easily. GRAFDISK also provides a screen save facility. Recommended by BBC MICRO USER, PCN, ELECTRONICS & COMPUTING, LASERBUG etc, used by universities, colleges and business, as well as the enthusiast.

SINGLE KEY: (requires 1.2 O.S) £5.00

SINGLE KEY ENTRY provides the user with single key entry of all 66 keywords on the BBC micro. Speeds up your program input, it's just like having 66 function keys and it only occupies 256 bytes. Compatible with BASIC 1 & Basic 2.

VIEWpoint: £12.00

VIEW PRINTER DRIVER FOR EPSON FX80 Multi-page drive with print menu allowing the setting of global (document wide) printer functions at printer initialisation.

- 1) Multiple choice of highlight options including underline, italics, bold, enlarged,

proportional, condensed, superscript, subscript.

- 2) Choice of any one of the nine language character sets held in the printer ROM.
- 3) Choice of PICA or ELITE type face.
- 4) Print intensity: normal or dark.
- 5) Single sheet or continuous printing.
- 6) Slow (accurate line feed) or fast print speed.
- 7) Choice of "PAD character. Selection of " as the PAD character switches off the backslash trap to allow full implementation of the foreign language character sets.

User Defined Character Definition

The print menu program also contains a sophisticated character generator which allows the construction of 95 user defined characters which are then accessible from VIEW via a highlight option. The characters are displayed in an 8x11 grid and can be printed (singly or as a set), stored, examined or changed at will.

Supplied on disc with comprehensive user manual.

THE NO1

All prices inclusive of VAT & Carriage—NO EXTRAS!

We're not short of Utility Software.

Clares[®]

MICRO SUPPLIES

MU9
98 Middlewich Rd.,
Northwich, Cheshire CW9 7DA
Tel: 0606 48511
Open 9—5pm Monday—Friday

high
e set our
e impossible
at some of
e impossible,
EPLICA II
ograms to
When you
o throw
ograms.
ograms,
ams that
to 6
length eg
for 6
ms load.
e user
ns and
o load the
e program
o buy just 1
gram—
16
ic capacity.

E!

ript,
anguage
OM.
ce.
ing.
print
tion of " "
the
entation
sets.

ins a
which
defined
ole from

8x11 grid
(t), stored,

ve user

riage—

are.

7DA



Clares
UTILITY SOFTWARE

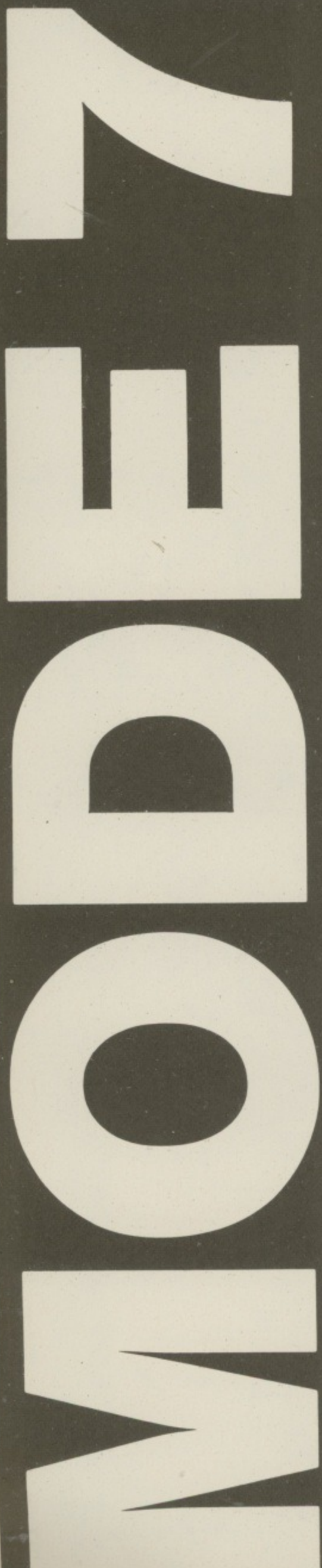

NIGEL PETERS continues his teletext tales . .

IN my last article about Mode 7 I dealt with the way we can use control codes to produce coloured text and backgrounds. We also learnt how to make the text flash and how to produce double height letters.

Now we'll go into using Mode 7's graphics capabilities. Although rather crude compared with the BBC Micro's other modes, Mode 7 can produce some entertaining displays as a glance at Ceefax or Oracle will show.

As we might expect from our earlier experiences, we access these graphics capabilities by making use of control codes. These tell the micro that instead of text it is to display block graphics.

These are rectangles made up of six squares, as shown in Figure I. Each block is the size of a capital letter.

Each of the six squares making up a block can be either on (that is, the foreground colour is shown) or off (the square is the background colour).

Lighting various combinations of these squares allows the micro to have available 64 different graphics characters. Figure II shows the shapes on offer.

When we want the micro to produce block graphics we use one of the control codes shown in Table I.

As you can see from this, seven codes are available. If we wanted to have red block graphics we would use:

```
PRINT CHR$(145)
```

in just the same way as previously we used:

```
PRINT CHR$(129)
```

to get red text.

However we have 64 block graphics characters to choose from. We have to tell the micro not only that we want block graphics and, at the same time, their colour, but also which character we want. This is done by using another set of control codes, those from 160 to 191 and 224 to 255.

The control codes and the character they refer to are shown in Figure II. Run Program I and you'll see them on the screen. The CHR\$(145) picks red

Code number	Graphics colour
145	red
146	green
147	yellow
148	blue
149	magenta
150	cyan
151	white

Table I: Block graphics codes

Getting to grips with graphics

graphics while the FOR...NEXT loops decide which blocks appear.

```
10 REM PROGRAM I
20 FOR code= 160 TO 191
30 PRINT code,CHR$(145)CHR$(code)
40 PRINT
50 NEXT code
60 FOR code= 224 TO 255
70 PRINT code,CHR$(145)CHR$(code)
80 PRINT
90 NEXT code
```

These shapes can be combined in many different ways to produce quite effective displays. Use PRINT and TAB along with Figure II and Table I to try your hand at Mode 7 graphics.

It's not hard, you just have to remember where on the screen each of the characters has to go and that the control codes, although invisible, take up a space.

You'll be pleased to know that the codes we learnt in the last article also



Figure I: Block graphics characters

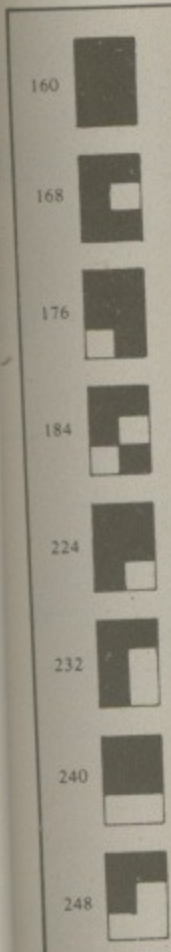

Figure II

work w
gram II

```
10 R
20 P
UR"
30 P
8)CHR$(
40 F
50
6)CHR$(
60
70
6)CHR$(
80
6)CHR$(
```

It's
what t

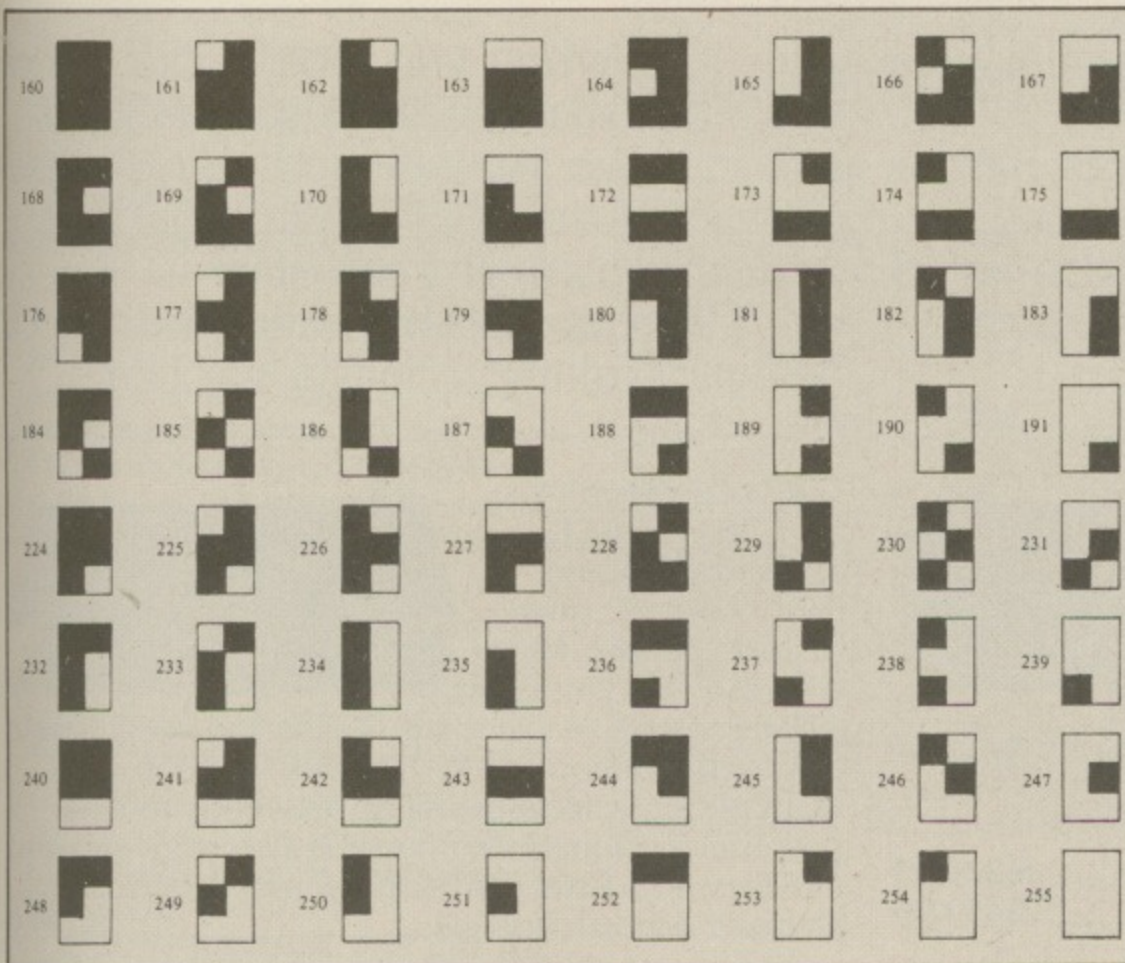

Figure II: Graphics characters and their codes

work with graphics characters. Program II shows them in action.

```

10 REM PROGRAM II
20 PRINT "DIFFERENT BACKGROUND COLOUR"
30 PRINT CHR$(130)CHR$(157)CHR$(148)CHR$(230)
40 PRINT "FLASHING"
50 PRINT CHR$(130)CHR$(157)CHR$(136)CHR$(148)CHR$(230)
60 PRINT "DOUBLE HEIGHT"
70 PRINT CHR$(130)CHR$(157)CHR$(136)CHR$(148)CHR$(141)CHR$(230)
80 PRINT CHR$(130)CHR$(157)CHR$(136)CHR$(148)CHR$(141)CHR$(230)

```

It's not always easy to remember what the code for a particular character

1	2
4	8
16	64

Figure III: Square values

is. Of course they're all shown in Figure II and on page 488 of the User Guide, but these may not always be available.

Happily there is a way of calculating the control code of a character. Each of the squares that makes a Mode 7 graphics character has a value, as shown in Figure III.

All you do when you want to know a character's code is to decide which squares are going to be in the foreground colour. Then total the values of those squares and add 160. The result is the control code for that character.

Although it sounds complicated, it's quite simple in practice. Certainly I find it a lot easier than looking through the lists when the character I want invariably seems to hide. Figure IV shows a sample calculation.

As you might guess, we can use combinations of the various graphics

```

10 REM PROGRAM III
20 PRINT CHR$(150)CHR$(183)CHR$(235)
30 PRINT CHR$(150)CHR$(189)CHR$(250)
40 PRINT CHR$(150)CHR$(245)CHR$(250)

```

blocks to produce something akin to user defined characters. If we wanted, for reasons best known to ourselves, to produce a cyan figure 8 three lines deep then we could use Program III.

Here the CHR\$(150) tells the micro that we want cyan block graphics while the other six codes define which shapes are to be used. Try varying the program with your own choice of character shapes.

Now after having given you Figure II, which lists the shapes available and their codes, I'll tell you that there's a different way of getting the blocks.

If you follow one of the graphics control codes with a string made up of lower case letters, numbers or punctuation marks you'll get graphics characters, not the letters or symbols you might expect.

Program IV shows this in action for each of the lower case letters of the alphabet.

```

10 REM PROGRAM IV
20 FOR x=1 TO 26
30 alphabet$="abcdefghijklmnopqrstuvwxyz"
40 string$=MID$(alphabet$,x,1)
50 PRINT CHR$(148);string$ CHR$(129)string$
60 PRINT
70 NEXT

```

The full set of symbols and the graphics characters they give are shown in Figure V.

Using this method we could produce our large 8 - magenta this time - in a much shorter program. Program V shows how this is done.

```

10 REM PROGRAM V
20 PRINT CHR$(149)"7k"
30 PRINT CHR$(149)"=n"
40 PRINT CHR$(149)"uz"

```

We could even replace three lines with one by using the control codes 10 and 8 to move the print cursor one space

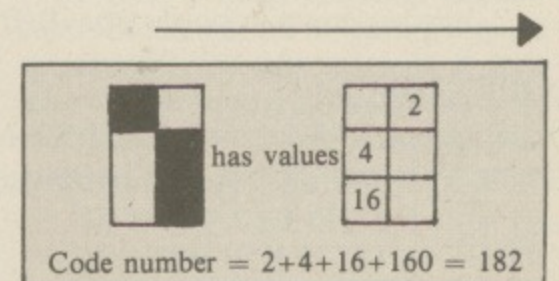

Figure IV: Calculating codes

From Page 51

down and one space left respectively. This is shown in Program VI.

```
10 REM PROGRAM VI
20 PRINT CHR$(149)"7k"CHR$(10)CHR$(8)CHR$(8)CHR$(8)CHR$(149)"=n"CHR$(10)CHR$(8)CHR$(8)CHR$(8)CHR$(149)"uz"
```

You'll notice that the whole thing is getting more and more like a user defined character, and you may be wondering if we could replace all those CHR\$s with a string of VDUs as we did at the end of the last article. The answer is yes, we can – and Program VII shows how it's done.

```
10 REM PROGRAM VII
20 VDU 149,183,235,10,8,8,8,149,189,238,10,8,8,8,149,245,250,10
```

It's much neater, but for the rest of the programs in this article I'll stick to using CHR\$. I think it makes things a little clearer.

If you're wondering what that last control code does, it just puts the prompt on the next line. Try leaving it out and see what happens.

Because the 149 code is still working on that line, the prompt is interpreted as a block graphics character with ugly results.

Before you read on, just make sure that you understand what we've covered above. Have a go at producing your own Mode 7 shapes on screen, using any of the methods outlined above.

You'll find that, with a little practice, it's quite easy to do.

Having got so far, now's the time to tell you that we've only dealt with one of the two forms of block graphics available in Mode 7.

We've been using contiguous block graphics. We could also have used something called separated graphics. Program VIII, a variant of Program IV, shows the difference.

```
10 REM PROGRAM VIII
20 FOR x=1 TO 26
30 alphabet$="abcdefghijklmnopqrstuvwxyz"
40 string$=MID$(alphabet$,x,1)
50 PRINT"CONTIGUOUS SEPARATE"
60 PRINTCHR$(148);string$,CHR$(154);string$
70 NEXT
```

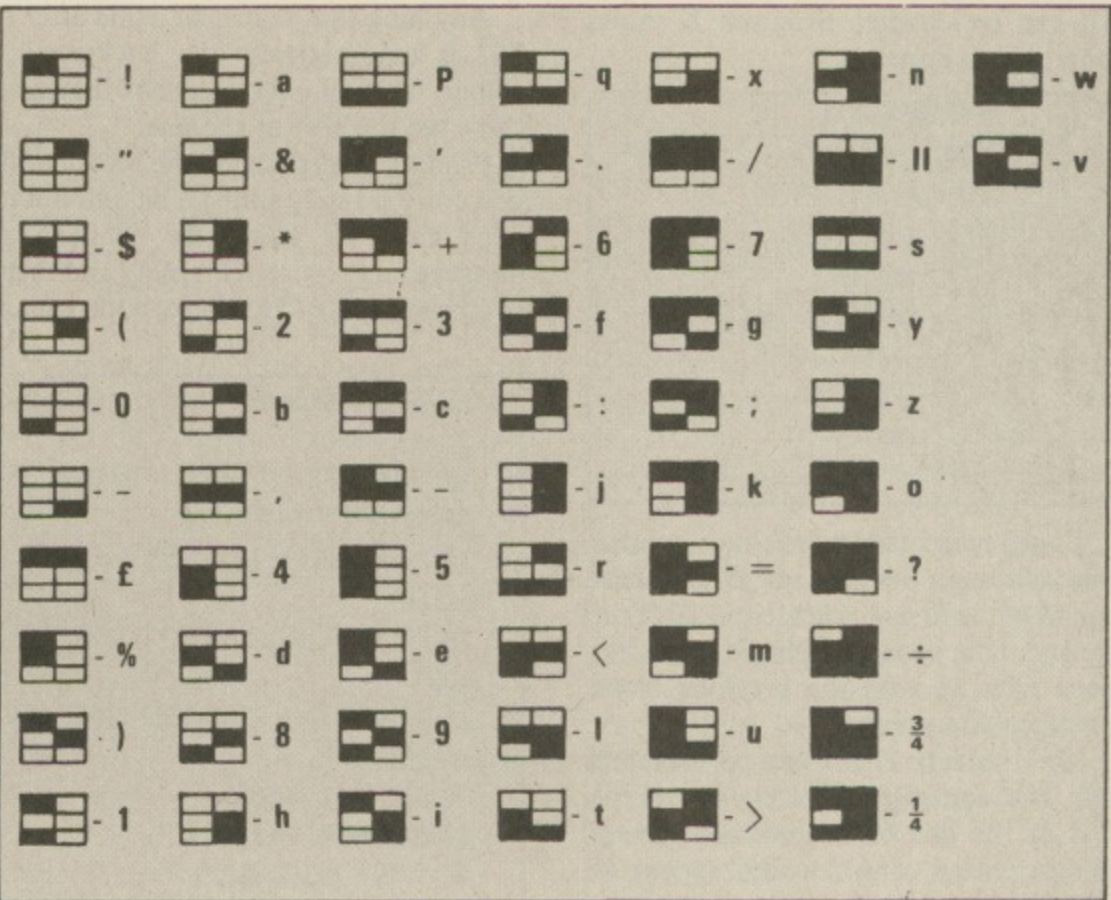

Figure V: Symbols for graphics blocks

As you can see, contiguous graphics have all the squares that make them up joined together. Separated graphics have all the six squares which make up that character separated by the background colour.

It's as though there's a border around each square, and consequently between adjoining characters on the same line. You get the "skeleton" of the block.

Contiguous block graphics are the default – the micro will use them unless you tell it differently. You can switch to separated graphics by using the control code 154 and back to contiguous graphics with control code 153.

Which you use depends on what effect you want. At times separated graphics look much neater than contiguous ones.

Try out some of the earlier programs

```
10 REM PROGRAM IX
20 PRINT CHR$(147);
30 FOR repeat=1 TO 10
40 PRINT CHR$(247);
50 NEXT repeat
60 PRINT CHR$(148);
70 FOR repeat=1 TO 10
80 PRINT CHR$(251);
90 NEXT repeat
100 PRINT
```

using CHR\$(154) to get separated graphics and see what you think.

While you've been playing around with Mode 7 you may have come up against the fact that the control codes, although invisible, take up a space on the screen.

While this doesn't matter too much in text, it can mess up graphics displays. You don't want gaps all over your beautiful artwork. Run Program IX and you'll see what I mean.

The program gives the 20 shapes required, but that gap in the middle spoils the effect. That's where the control code 148 is hiding.

You might have wondered if there was a way round this effect and there is, using yet another set of control codes.

Control code 158 has the effect of holding the graphics. What this means is that when you use that code in a line the micro will carry on printing out the required block graphics characters.

However when it comes to another control code, instead of leaving a space as normal it fills that space in. It does this with the same graphics character as the last one it used. So by using the hold graphics code the ugly gap of Program

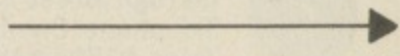

From Page 53

IX can be avoided. Program X shows how this is done.

```
10 REM PROGRAM X
20 PRINT CHR$(147);
30 FOR repeat=1 TO 10
40 PRINT CHR$(247);
50 NEXT repeat
60 PRINT CHR$(158)CHR$(148);
70 FOR repeat=1 TO 10
80 PRINT CHR$(251);
90 NEXT repeat
100 PRINT
```

Eagle-eyed readers will have spotted that, although the lines are joined, there are 11 of the first character and 10 of the second. The space of Program IX has been filled in with the previous block graphics character.

This holding effect can be switched off. The control code 159 returns the rest of the line to the normal way of things, where control codes appear as spaces.

And that's nearly the end, apart from

one last control code, 152. This conceals the display.

Anything that comes in a line after a 152 is automatically the background colour. This, of course, means that you can't see the rest of the line.

Printing something on the screen that you can't see may sound a bit daft but it does have its point. By printing a message on the screen invisibly and then overprinting the 152 control code with a

```
10 REM PROGRAM XI
20 CLS
30 PRINT TAB(1,11)CHR$(130)CHR$(15
2)"GREEN"
40 PRINTTAB(1,12)CHR$(131)CHR$(152
)"YELLOW"
50 PRINTTAB(1,13)CHR$(132)CHR$(152
)"BLUE"
60 PRINT TAB(1,23)"PRESS SPACE FOR
NEXT COLOUR"
70 FOR X=11 TO 13
80 WAIT$=GET$
90 PRINT TAB(2,X)" "
100 NEXT
```

space you can make things appear as if by magic. In a way, it's the Mode 7 version of VDU 19.

Program XI shows you the conceal display control code in action. You don't see the messages until the code is overwritten with a space.

And that's the end of our tour of Mode 7. Table II sums up these last control codes.

Control code	Result
152	Conceal display
153	Contiguous graphics
154	Separated graphics
158	Hold graphics
159	Release graphics

Table II: Graphics control codes

As you can see, the basics of the mode are quite simple, but the effects obtained using the control codes can be complicated. And the great advantage is that you aren't using up lots of precious memory.

Have fun!

StarBASE... a new database

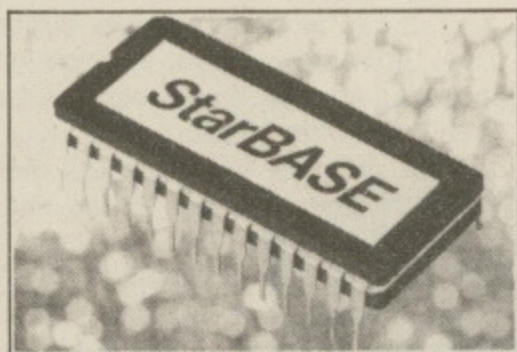

StarBASE... for the BBC

Will now mail merge with Wordwise or View

STOCK SUBJECT TO PRIOR SALE

Local authority enquiries welcome.
Prices correct at time of going to press.



GCC (Cambridge) Limited
66 High Street, Sawston, Cambridge CB2 4BG
Telephone: Cambridge (0223) 835330/834641
Telex: 81594 SAWCOM

The StarBASE professional database management system consists of a 16K ROM, 51K of extension and applications software on disc and a comprehensive manual. StarBASE was designed by a chartered electronics and software engineer to meet a defined need for a high specification, disc-based random access system. The database program and extension software is "Menu Driven", particularly user-friendly, quick to use, but extremely powerful and totally flexible. It is absolutely ideal for use in schools, clubs, colleges, small businesses and in the home.

- Menu Driven throughout
- True random access - will locate a single record in under 2 seconds typically.
- File size is the capacity of a single disc (double sided if applicable) - minus 5K.
- Maximum number of fields 69.
- Maximum number of characters in a field 255 (subject to an overall maximum of 920 in a record).
- Up to 4096 records.
- Records are displayed and input on a "Card Screen" principle. Layout of fields and headings are built entirely by the user by "Painting" on the screen (colour can be used).
- Direct and rapid entry of data into all or selected fields.
- Search criteria include =, <, >, <, and a wildcard "anywhere in the field".
- Unlimited and rapid sequential searching and selecting.
- All or selected records can be sorted to a depth of 5 fields, each in ascending or descending order, using the super-fast Shell-Metzner routine.
- Instant print or display review of file, giving breakdown of record size, number of records possible and space used, etc.
- Address and label printing (up to 8 across the page).
- Selected whole or part field-content printing, with left and right justification, tabbing, and embedded printer control codes possible. Can be mixed with text for invoices and form letters etc.
- Can be configured for any printer (including £ character definition).
- Continuous or paged printout with page heading and pause at each page end, with "New Page" prompt.
- Repeat printing for multiple copies.
- Percentage and arithmetic operations to specified decimal placing.
- Field statistics giving totals, mean and standard deviation, variance and squares.
- Optional password lock.
- Fully documented routines (in Basic) which can be spooled onto user-written tailor-made file management and interrogation programs.

StarBASE meets and even exceeds professional standards found on large installations. It is unique in speed, flexibility and ease of use.

Price? Only £69.00 inc VAT (plus £1.50 p & p).

MAKE THE MOST OF YOUR JOYSTICK

When you bought your BBC Model B, or a PLUS 1 or one of the other analogue interfaces for the ELECTRON, then you paid out a fair amount of money for the A/D converter. Don't waste it by buying switched joysticks. ACORN did not put all this additional cost onto the machines without considering its worth against a switched joystick option which could have been run from the user port without any additional hardware.

A switched joystick cannot properly simulate an analogue one but an analogue one can simulate a switched one with extra facilities. Three types of joystick are around for the BBC at the moment. These are:-

- (a) Switched type that plugs into the user port.
- (b) Switched type modified to plug into the analogue port.
- (c) Fully analogue.

Firstly, don't buy a switched joystick that plugs into the user port. Joystick software for the BBC is written to run from the analogue port. A joystick of this type will need a conversion routine, even to run programs that have an ACORNSOFT compatible joystick option. Conversion software can cause problems, it can interact with the hardware timers in the user port, or affect the speed of the game, or sometimes the conversion cannot be located because all available memory is used.

The switched type of joystick that plugs into the analogue port has been fitted with resistors to give

three values in any plane. These values are full on, full off or half way. This type of joystick will run programs which only require up, down, left, right or diagonal movement in one speed.

The type of joystick really intended to be used on the BBC is a fully analogue one. Few programs are around yet which really take advantage of the variable rates and angles that can be used with this type. Two programs that do are AVIATOR and SNOOKER from ACORNSOFT and you need analogue joysticks to play the joystick versions of these programs. On AVIATOR the joystick replaces the real Spitfire's joystick. A slight movement of the joystick will cause the plane to change direction slowly and a large movement will make it change direction sharply.

In SNOOKER the angle of the shot is directly related to the angle of the joystick and the strength of the shot is determined by the deflection of the joystick from the centre position.

Most things in real life are analogue. For instance, imagine driving a car with only idle or flat out, forwards or backwards and brakes that were either hard on with the wheels locked or not on at all. Imagine picking up an egg with a hand that was either open or fully closed. An attempt can be made to simulate analogue movement with switches by causing the switch to adjust the rate at which something is moved. The keyboard version of AVIATOR is like this—as long as

you hold down a key the aircraft joystick is moved in that direction—O.K until you need to suddenly swing the other way because you will have to wait while the joystick is driven back to centre and then off in the other direction.

In the on-going debate as to whether video games are good or bad for young children; one of the "for's" is that they improve co-ordination between hand and eye. This is only true if there is a direct relationship between the position of the hand (joystick) and the object on the screen. It is not really improving co-ordination if the object moves at a rate determined by software regardless of the relative position of the stick or the pressure applied to it or the speed that is moved.

Similarly the absolute position of a cursor in a graphics program is best done with analogue joysticks. The cursor can be moved a tiny bit by making a fine adjustment in any direction or can be put the other side of the screen as quick as the joystick can be moved.

To help you make the most of your joystick we are offering free listings of some useful joystick utilities for just sending us a stamped addressed envelope and returning the enclosed form.

by *Tony Pearmain*

Please send me a listing of the following joystick utilities and more information on the Voltmace Delta range of analogue joysticks:-

1. A utility to simulate a switched joystick action on an analogue joystick with adjustable sensitivity.
2. A utility to convert games like SNOOKER from two joysticks to run on one joystick. This can also be used to transfer action from one joystick to another if one joystick is faulty. This program works very well for a single DELTA 14b where each player has his own fire button.
3. For DELTA 14b & 14b/1 owners a utility to transfer existing joystick software to the side socket of the A/D/USER PORT INTERFACE to save changing the joystick over after running keyboard/joystick conversions.

Please answer these questions:-

Do you own a joystick? yes no

If yes please give make

Are you satisfied with your joystick? yes no

If no please state why

Please send your form and stamped addressed envelope to:-

VOLTMACE LIMITED, PARK DRIVE, BALDOCK, HERTS, SG7 6EV.
Telephone (0462) 894410

Get Mode 7 graphics into print with JIM NOTMAN's

Teletext screen dump

P.142 DATEXT (P100-149) PAGE ???
Daddy was late

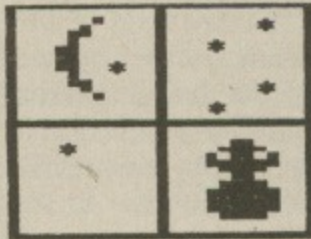

It was a cold winter's night and daddy was late. Katie and Paul looked out of the window for him. They saw a snowman. "Mummy there's a snowman in our garden," they said. "Let me see," said mummy. "Oh yes," she said.

press SPACE for next page

P.143 DATEXT (P100-149) PAGE ???
Daddy was late

(continued)
The snowman moved.
"Look mummy, the snowman is moving."
The snowman walked up the path.
Katie and Paul were scared.
Knock, knock on the door went the snowman.
"Let me in," said the snowman.

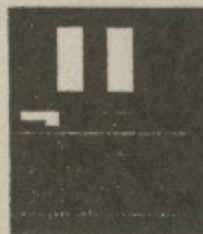

press SPACE for next page

P.144 DATEXT (P100-149) PAGE ???
Daddy was late

(continued)
"I'm daddy. I'm all covered in snow."
Katie and Paul giggled. They let him in. They were pleased. Their daddy was a snowman.

THE END.



INTEREST in Mode 7 has greatly increased over the past few months. Its economical use of memory is especially important if you also have a DFS, which reserves nearly 4k for its own use.

Also access to transmitted screens is becoming more common with Prestel, Micronet, Ceefax and Oracle.

With this interest comes the need to dump screens of information onto a printer.

But before this can be done a number of problems need to be overcome.

Teletext characters are divided into both printable and control characters, which are responsible for the many special effects that can be produced.

These control codes have an effect on all the rest of the characters on that screen line unless a control code to cancel or alter the command is given.

For example, if the control code 129 is found at the start of the line, all the rest of the characters will be printed in red.

However if that code is 145, instead of the normal keyboard characters (except for upper case letters), graphics symbols will be printed instead. These form part of a 3 x 2 mosaic, the parts that are printed depending on the Ascii value of the character (see Figure I).

As a further complication, these graphics can be printed together or

1	2
4	8
16	64

To find the Ascii value of a graphics character add together the value of each part of the mosaic that is to be printed, then add 32.

Figure I

slightly separated. It is also possible for characters to be printed double height.

Another problem is that a number of the characters differ between Modes 0-6 and Mode 7 (see Figure II).

Mode 7 has its own character generator which uses different numbers for some characters to those used in Modes 0-6 (see Figure III).

In normal use you are unaware of this

xt
mp

has greatly
months. Its
is especially
DFS, which
own use.
ed screens is
with Prestel,
cle.
the need to
ion onto a
ne a number
rcome.
divided into
characters,
the many
roduced.
an effect on
ers on that
ol code to
d is given.
code 129
ine, all the
printed in
45, instead
characters
, graphics
ead. These
, the parts
the Ascii
Figure I).
on, these
together or

ii value
character
e value
of the
to be
ld 32.

ossible for
le height.
number of
Modes 0-6
character
numbers
used in
re of this

PROGRAM DESCRIPTION

Lines	Description	Lines	Description	Lines	Description
50	PROCinit defines the non-standard characters required for Mode 7.	290	If your printer needs a line feed (char. 10) to go onto the next line - that is, you have to type in *FX6 before you normally do any printing - make sure you include the 10 in the statement, otherwise it can be omitted.	750	Defines character 226.
60	Loads the screen file that is going to be dumped.	320	This is important if the Escape key is pressed during the dump. After the command on line 120 the printer expects 320 bytes of graphic information. If it doesn't the results are, to say the least, interesting!	760	s% is a pointer to the defined character.
70	Points to the error handling routine.	380-420	Sets up some variables and flags.	770	Gives the defined character to the output routine.
80	Enable output to printer.	430-520	Defines those characters which differ between Mode 7 and the other modes.	810-830	Works out the offset to the defined character table in page &C00 (as defined by PROCinit).
90	Makes sure that the printer starts on a new line.	530	Assembles a short piece of machine code.	840	Points to the defined character for the output routine.
100	Loop counter for the screen rows.	570-580	Flags and pointers which let the program know whether it is the upper part or the lower part or a double height character that is to be printed.	880-890	All the characters of Mode 0 to 6 are defined in the operating system starting at &C000. s% will point to the start of the character definition.
110	Resets these flags at the start of each line.	620-730	Calculates values for a character definition according to the formula given in Figure I. Since defined characters have an 8 x 8 matrix and teletext graphics have a 3 x 2 format, the top and bottom graphics blocks are given three lines each while the middle blocks are given two.	900	Points to the character definition for the output routine.
120	A command to the printer telling it to expect 320 bytes of 8 bit graphic data.	740	Alters the graphics variables if the separate graphics flag is set.	940	When the double height flag is set, this routine checks whether it is the top or bottom line of the character...
130	Loop counter for each character position in the current row.			950	... then either the top line or the bottom line is copied to another location, doubling its height in the process.
140	Moves current text pointer.			990	Enlarges character if necessary.
150	Gives the Ascii value of the character under the text pointer.			1000	!&80 points to the start of the character definition.
160-210	Sets program flags according to any teletext control codes.			1010	!&82 points to the locations where the manipulated character is to be placed.
220	If it was a control code or a 'space', sends a series of 8 zeros to the printer.			1020	Calls the machine code manipulation routine.
230	GOTO the graphics routine if the graphics flag has been set, but not if the character is upper case or a #.			1030	Outputs the character to the printer.
240	Swaps certain characters around so that the character set 160-254 is the same as those 32-126.			1070-1590	Assemble the character manipulation routine.
250	Picks out the teletext characters which differ in Modes 0-6.			1640-1670	Simple routine to load a Mode 7 screen file.
260	Prints a "normal" character.				
280	close is a flag which is set if the previous line had a double height or graphics character. If close is set, a				

because the operating system swaps them around without you knowing. To confirm this try this experiment.

After the screen has been cleared, type in:

?&7C00=35

A £ sign will appear in the top left of the screen. Now type in:

VDU 35

This time a # sign will be printed, confirming that character number 35 can appear differently depending on whether it is printed using the operating system or placed in the screen memory directly.

There are a number of different ways

Ascii	Mode 7	Mode 0 to 6
91	←	
92	½	\
93	→	
94	↑	^
95	-	-
123	¼	{
124		!
125	¾	}
126	÷	~
255	■	

Figure II: Different characters in Mode 7 and Modes 0 to 6

Teletext Internal Number	Converted to	
	95	35
96	95	-
35	96	£

Figure III: "Swap around" character.

a teletext screen dump program can be written:

- The Mode 7 display could be converted into another screen mode and then put on a printer using a standard screen dump routine. (You'll run out of memory if you add this program onto another one.)

- Define all the special characters required in the printer itself. (OK if you have a printer in which characters can be defined - even the best printers find this task daunting if all possible teletext characters are to be translated.)

- Stay in Mode 7, but give the printer

NOW AVAILABLE
FROM JOHN MENZIES
AND W.H. SMITH

A DOUBLE-SIDED 3" DISC DRIVE AT A SINGULAR PRICE.

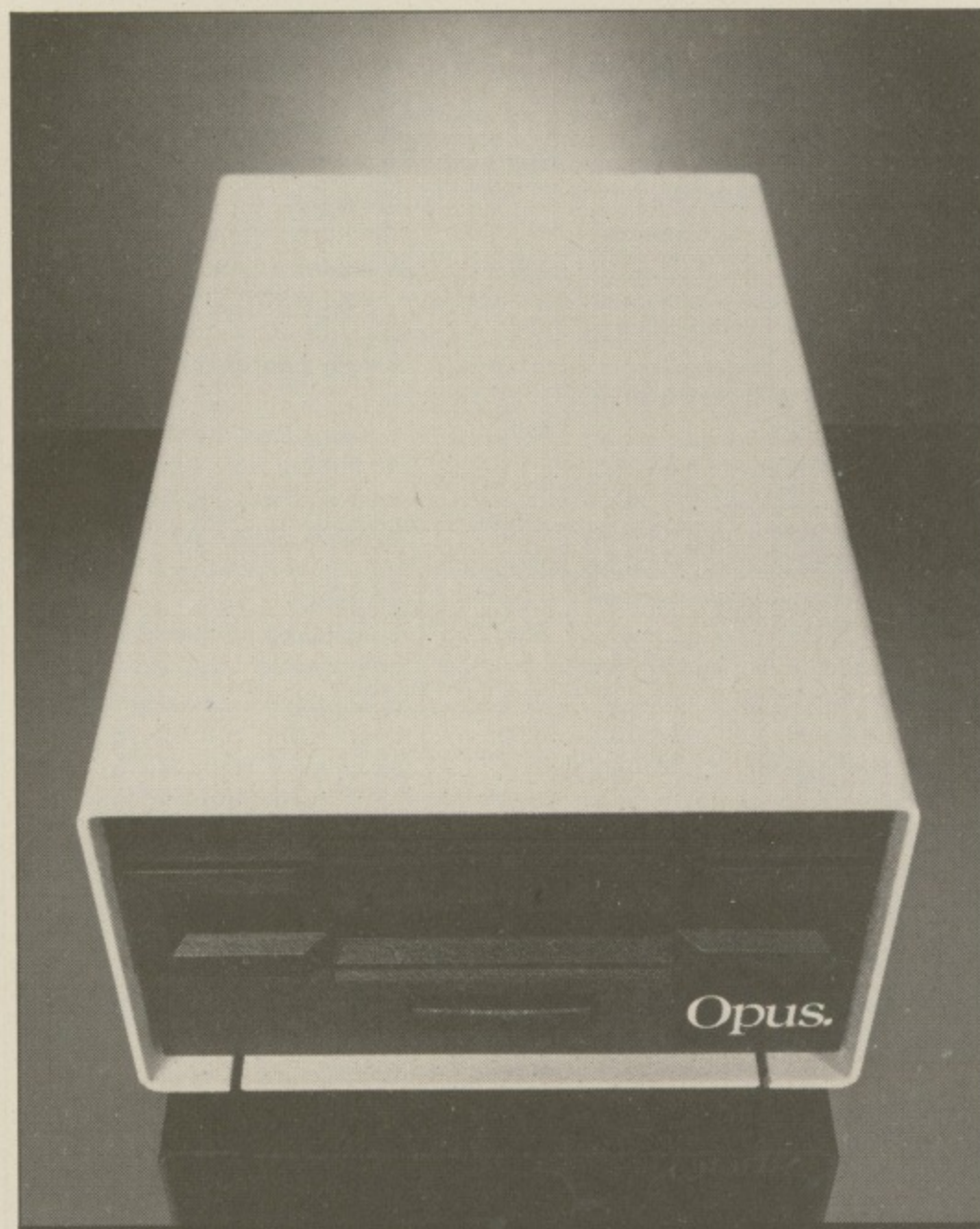

THE OPUS
SUPER 3 MICRODRIVE.
£229.95 (INC. VAT)
FOR USE WITH YOUR BBC MICRO.

For only £229.95 (and that includes VAT and all the necessary leads) you can have an OPUS 500k double-sided disc drive. And remember 3" disc drives are fast becoming the standard for home and business use.

This is an even bigger bargain than it sounds. For you're getting a double sided drive at the price that other company's sell single sided drives for. It reads and writes to the disc cartridge from both sides, giving you twice the on-line capability of other 3" drives. And there's no need to flip the disc over!

STATE OF THE ART TECHNOLOGY FEATURING:

- Easy to connect to the BBC Micro
- Compatible with most other makes
- Comprehensive manual
- Free disc cartridge
- Format, verify and other utilities provided
- Direct Drive
- Double sided
- One touch cartridge load
- 3 ms access time
- Portable, compact and reliable
- Two years' full guarantee
- Totally compatible with 5W's

TECHNICAL PERFORMANCE.

	Single Density	Double Density
Capacity	250K Bytes	500K Bytes
Recording density	4,915 BP1	9,830 BP1
Track density	100 TP1	100 TP1
Total number of tracks	40 (each side)	40 (each side)
Recording method	FM	MFM
Rotational speed	300 RPM	300 RPM
Transfer rate	125K Bits/Sec	250K Bits/Sec
Access time track to track	3 ms	3 ms
Access time settling	20 ms	20 ms
Motor start time	0.5 sec	0.5 sec

The Opus Super 3 Microdrive is now available from W.H. Smith, John Menzies and leading specialist shops. Dual disc drives are also available for £460.

OPUS SUPPLIES LTD.
158 Camberwell Road, London SE5 0EE.
Opening hours: 9.00-6.00 Monday-Friday, 9.00-1.30p.m. Saturday.  01-701 8600 / 01-703 6150

To: Opus Supplies Ltd., 158 Camberwell Road, London SE5 0EE. Please rush me the following: **(ALL PRICES INCLUDE VAT & CARRIAGE.)**

Quantity	Description	Price
	Single drive(s) at £229.95 ea.	
	Dual drive(s) at £459.95 ea.	
TOTAL		

I enclose a cheque for £ _____
Or please debit my credit card account with the amount of £ _____ **BU28**
My Access/Barclaycard (please tick) No. is _____

Name _____
Address _____
Telephone _____

Opus
Opus Supplies Ltd.

From Page 57

the information it would have received from a screen dump. (Not the easiest way, but a good challenge!)

Basically, the method chosen for the program described here is to send a stream of graphics data for what the printers term an 8 bit graphics dump. The information for each character is sent as a series of 8 bytes.

For normal characters this information is found in a table in the operating system starting at &C000. This contains the definitions for the characters of Mode 0-6.

The characters which vary from Mode 7 are defined by the program and placed on page &C. The graphics characters are decoded according to their Ascii number and the definition put in page &C starting at &C10.

If any of these characters is to be double height, the single height character is "expanded" and the definition placed in page &C starting at &C08.

When characters are defined using VDU23, or are predefined in the

character table in the operating system, they are defined from top to bottom in rows in line with the way that the TV screen is normally scanned.

Printers however usually print columns of vertical dots to make up a character.

To translate these VDU definitions into a form which a printer with 8 bit imaging can understand, a short machine code routine is used as Basic would be too slow.

The output definition is also stored on page &C starting at &C00.

The program is designed to be compatible with Basic I and Basic II. If you only want to use this program with Basic II, replace line 1650 with:

```
OSCLII*LOAD "+file$+" 7C00"
```

and delete 1660 and 1670.

As written, this program works with Epson printers such as the FX80 and RX80. Conversion to other printers with an 8 bit imaging mode is possible by changing the commands in certain lines:

120 Tells the printer to expect 320 bytes of 8 bit graphic data.

280 Is concerned with the spacing between lines.

290 Commands for carriage return and line feed.

330 Command to reset the printer.

This program can be made to occupy less space in memory by saving the character definitions and machine code separately.

After the program has been typed in, tested and saved, clear the memory with:

```
*FX200,3
```

and press the Break key.

Load in the program and enter:

```
PROCinit
```

to define different characters and assemble the machine code on page &C.

Save these with:

```
*SAVE code C00 +FF
```

Lines 430-520 and 1060-1600 can now be deleted. Alter line 530 to:

```
*LOAD code
```

then save the shortened Basic program.

Remember in future that code must always be available for loading after the Basic.

Teletext listing

```
10 REM Teletext Screen Dump
20 REM Jim Notman (c) 1984
30
40 MODE 7
50 PROCinit
60 PROCload
70 ON ERROR GOTO 320
80 VDU 2
90 PRINT
100 FOR Y%=0 TO 24
110 graph=FALSE
    :double=FALSE
    :separate=FALSE
    :close=FALSE
120 VDU 1,27,1,75,1,64,1,1
130 FOR X%=0 TO 39
140 VDU 31,X%,Y%
150 R%=(USR (&FFF4)AND &FFFF)
    DIV 256
160 IF R%>128 AND R%<136
    THEN graph=FALSE
170 IF R%=140
    THEN double=FALSE
180 IF R%=141
    THEN double=TRUE
    :close=TRUE
    :PROCsetline
190 IF R%>144 AND R%<152
    THEN graph=TRUE
    :close=TRUE
200 IF R%=153
    THEN separate=FALSE
210 IF R%=154
    THEN separate=TRUE
220 IF (R%AND &7F)<33
    THEN FOR LX=0 TO 7
        :VDU 1,0
    :NEXT
    :GOTO 270
230 IF graph=TRUE AND NOT (R%=35
    OR (R%>63 AND R%<95)OR (R%>191
    AND R%<224))
    THEN PROCgraph(R%)
    :GOTO 270
240 IF R%=163
    THEN R%=96
    ELSE IF R%=223
    THEN R%=35
    ELSE IF R%=224
    THEN R%=95
250 IF (R%>90AND R%<96)OR (R%>122
    AND R%<128)OR (R%>218AND R%<223)
    OR (R%>250AND R%<256)
    THEN PROCdiff(R%)
    :GOTO 270
260 PROCprint(R%)
270 NEXT
280 IF close=TRUE
    THEN VDU 1,27,1,65,1,8
    ELSE VDU 1,27,1,65,1,9
290 VDU 1,13,1,10
300 NEXT
310 VDU 26
320 IF JX<41
    THEN FOR LX=0 TO (41-JX)*8
        :VDU 1,0
    :NEXT
330 VDU 1,27,1,64,3
340 IF ERR <>0
    THEN REPORT
    :PRINT " on line ";ERL
350 END
360
370 DEF PROCinit
380 A%=135
    :p%=&C00
    :m%=&C08
    :b%=&C000
390 DIM cmd% 25
400 setline=-2
410 top=FALSE
420 bottom=FALSE
430 VDU 23,227,0,16,32,127,32,16
    ,0,0
440 VDU 23,228,64,64,64,76,82,4
    ,8,30
450 VDU 23,229,0,4,2,127,2,4,0
    ,0
```

Electronequip

(Authorised BBC Dealer, and service centre)

BBC Cassette Software		Exc VAT	Inc VAT	BBC Cassette Software		Exc VAT	Inc VAT	BBC Cassette Software		Exc VAT	Inc VAT
BCADFOOT	Addictive Football Manager	5.87	6.75	BCBEWRDH	BES Wordhang (XBEO2)	6.63	7.62	BCMSQUIC	Mirrorsoft Quick Thinking (B)	5.13	5.90
BCAFBOUN	A & F Software Bouncer	5.92	6.80	BCBEWRW	BES World-Wise (XBEO1)	6.63	7.62	BCOCMRWI	Ocean Mr. Wimpy	5.10	5.87
BCAFCHIC	A & F Software Chuckie Egg	5.84	6.72	BCBSBEYO	BBSoft Beyond Basic Cassette (B)	8.50	9.78	BCPAFORT	Pace Software Fortress	6.61	7.60
BCAFCYLO	A & F Software Cylon Attack	5.92	6.80	BCBSBANY	BBSoft Canyon (B)	7.39	8.50	BCPPADVE	Program Power Adventure (B)	5.87	6.75
BCAFFROG	A & F Software Frogger	5.92	6.80	BCBSBDRW	BBSoft Drawing	7.40	8.50	BCPPALID	Program Power Alien Destroyers (Invader)	5.91	6.78
BCAFHARR	A & F Software Horror Castle	5.92	6.80	BCBSBDRWH	BBSoft Dr Who: The First Adventure (B)	7.39	8.50	BCPPALIE	Program Power Alien Swirl	5.13	5.90
BCAFHOWS	A & F Software Howzat	5.10	5.87	BCBSSEARL	BBSoft Early Learning	7.40	8.50	BCPPASTE	Program Power Asteroid Storm (B)	5.87	6.75
BCAFPAIN	A & F Software Painter	5.92	6.80	BCBSFUNG	BBSoft Fun Games	7.40	8.50	BCPPASTR	Program Power Astro Navigator	4.21	4.84
BCAFPAPH	A & F Software Pharaohs Tomb	5.92	6.80	BCBSGAMS	BBSoft Games of Strategy	7.40	8.50	BCPPBAND	Program Power Bandits at 3 o'clock	5.14	5.91
BCAFPAN	A & F Software Pharaohs Tomb	5.92	6.80	BCBSHOMF	BBSoft Home Finance	7.40	8.50	BCPPBARR	Program Power Barrage for BBC	5.13	5.90
BCAFPAN	A & F Software Pharaohs Tomb	5.92	6.80	BCBSMAKM	Making the most of your Micro (Inc book)	9.57	11.01	BCPPBEEB	Program Power Beeb-Tote (B)	4.40	5.08
BCAFPAN	A & F Software Pharaohs Tomb	5.92	6.80	BCBSMOTO	BBSoft Motorists' Log	7.40	8.50	BCPPBUMB	Program Power Bumble Bee (B)	5.87	6.75
BCAFPAN	A & F Software Pharaohs Tomb	5.92	6.80	BCBSMUSI	BBSoft Music	7.40	8.50	BCPPCAVA	Program Power Caveman Adventure	5.06	5.82
BCAFPAN	A & F Software Pharaohs Tomb	5.92	6.80	BCBSMUSI	BBSoft Music	7.40	8.50	BCPPCH16	Program Power BBC Chess (16K)	3.66	4.23
BCAFPAN	A & F Software Pharaohs Tomb	5.92	6.80	BCBSMUSI	BBSoft Music	7.40	8.50	BCPPCHEM	Program Power Chemistry	5.13	5.90
BCAFPAN	A & F Software Pharaohs Tomb	5.92	6.80	BCBSMUSI	BBSoft Music	7.40	8.50	BCPPCHES	Program Power Chess	5.87	6.75
BCAFPAN	A & F Software Pharaohs Tomb	5.92	6.80	BCBSMUSI	BBSoft Music	7.40	8.50	BCPPCONS	Program Power Constellation	5.87	6.75
BCAFPAN	A & F Software Pharaohs Tomb	5.92	6.80	BCBSMUSI	BBSoft Music	7.40	8.50	BCPPCOSM	Program Power Cosmic Combat (B)	5.14	5.91
BCAFPAN	A & F Software Pharaohs Tomb	5.92	6.80	BCBSMUSI	BBSoft Music	7.40	8.50	BCPPCOWB	Program Power Cowboy Shoot-out	5.06	5.82
BCAFPAN	A & F Software Pharaohs Tomb	5.92	6.80	BCBSMUSI	BBSoft Music	7.40	8.50	BCPPCROA	Program Power Croaker	5.87	6.75
BCAFPAN	A & F Software Pharaohs Tomb	5.92	6.80	BCBSMUSI	BBSoft Music	7.40	8.50	BCPPCYBE	Program Power Cybertron Mission (B)	5.87	6.75
BCAFPAN	A & F Software Pharaohs Tomb	5.92	6.80	BCBSMUSI	BBSoft Music	7.40	8.50	BCPPDIANG	Program Power Danger! UXB	5.87	6.75
BCAFPAN	A & F Software Pharaohs Tomb	5.92	6.80	BCBSMUSI	BBSoft Music	7.40	8.50	BCPPDEMO	Program Power Demon Decorator (Painter)	5.06	5.82
BCAFPAN	A & F Software Pharaohs Tomb	5.92	6.80	BCBSMUSI	BBSoft Music	7.40	8.50	BCPPDIS	Program Power BBC Disassembler	5.06	5.82
BCAFPAN	A & F Software Pharaohs Tomb	5.92	6.80	BCBSMUSI	BBSoft Music	7.40	8.50	BCPPELDO	Program Power Eldorado Gold (Adventure)	5.06	5.82
BCAFPAN	A & F Software Pharaohs Tomb	5.92	6.80	BCBSMUSI	BBSoft Music	7.40	8.50	BCPPESCA	Program Power Escape from M'base Alpha	5.87	6.75
BCAFPAN	A & F Software Pharaohs Tomb	5.92	6.80	BCBSMUSI	BBSoft Music	7.40	8.50	BCPPFFAC	Program Power Felix in the Factory	5.87	6.75
BCAFPAN	A & F Software Pharaohs Tomb	5.92	6.80	BCBSMUSI	BBSoft Music	7.40	8.50	BCPPFFRU	Program Power Felix & the Fruit Monsters	5.87	6.75
BCAFPAN	A & F Software Pharaohs Tomb	5.92	6.80	BCBSMUSI	BBSoft Music	7.40	8.50	BCPPFOOT	Program Power Footer	5.87	6.75
BCAFPAN	A & F Software Pharaohs Tomb	5.92	6.80	BCBSMUSI	BBSoft Music	7.40	8.50	BCPPGALA	Program Power Galactic Commander	5.87	6.75
BCAFPAN	A & F Software Pharaohs Tomb	5.92	6.80	BCBSMUSI	BBSoft Music	7.40	8.50	BCPPGHOU	Program Power Ghoul	5.87	6.75
BCAFPAN	A & F Software Pharaohs Tomb	5.92	6.80	BCBSMUSI	BBSoft Music	7.40	8.50	BCPPHELL	Program Power Hell Driver (B)	5.87	6.75
BCAFPAN	A & F Software Pharaohs Tomb	5.92	6.80	BCBSMUSI	BBSoft Music	7.40	8.50	BCPPINTE	Program Power Intergalactic Trader (B)	6.61	7.60
BCAFPAN	A & F Software Pharaohs Tomb	5.92	6.80	BCBSMUSI	BBSoft Music	7.40	8.50	BCPPJETP	Program Power Jet Power Jack	5.87	6.75
BCAFPAN	A & F Software Pharaohs Tomb	5.92	6.80	BCBSMUSI	BBSoft Music	7.40	8.50	BCPPKILL	Program Power Killer Gorilla	5.87	6.75
BCAFPAN	A & F Software Pharaohs Tomb	5.92	6.80	BCBSMUSI	BBSoft Music	7.40	8.50	BCPPLABE	Program Power Labyrinths of la Coshe	5.87	6.75
BCAFPAN	A & F Software Pharaohs Tomb	5.92	6.80	BCBSMUSI	BBSoft Music	7.40	8.50	BCPPPLAC	Program Power Laser Command	5.87	6.75
BCAFPAN	A & F Software Pharaohs Tomb	5.92	6.80	BCBSMUSI	BBSoft Music	7.40	8.50	BCPPPLAS	Program Power Martian Attack (B)	5.87	6.75
BCAFPAN	A & F Software Pharaohs Tomb	5.92	6.80	BCBSMUSI	BBSoft Music	7.40	8.50	BCPPPMAS	Program Power Mastermind for BBC	3.36	3.84
BCAFPAN	A & F Software Pharaohs Tomb	5.92	6.80	BCBSMUSI	BBSoft Music	7.40	8.50	BCPPMAZE	Program Power Maze Invaders (B)	4.40	5.08
BCAFPAN	A & F Software Pharaohs Tomb	5.92	6.80	BCBSMUSI	BBSoft Music	7.40	8.50	BCPPMINE	Program Power Mine (B)	5.87	6.75
BCAFPAN	A & F Software Pharaohs Tomb	5.92	6.80	BCBSMUSI	BBSoft Music	7.40	8.50	BCPPMOON	Program Power Moon Raider	5.87	6.75
BCAFPAN	A & F Software Pharaohs Tomb	5.92	6.80	BCBSMUSI	BBSoft Music	7.40	8.50	BCPPNEME	Program Power Nemesis (B)	5.87	6.75
BCAFPAN	A & F Software Pharaohs Tomb	5.92	6.80	BCBSMUSI	BBSoft Music	7.40	8.50	BCPPPOKE	Program Power Poker Dice (B)	4.40	5.08
BCAFPAN	A & F Software Pharaohs Tomb	5.92	6.80	BCBSMUSI	BBSoft Music	7.40	8.50	BCPPPOSI	Program Power Positron (B)	5.14	5.91
BCAFPAN	A & F Software Pharaohs Tomb	5.92	6.80	BCBSMUSI	BBSoft Music	7.40	8.50	BCPPPREV	Program Power Reversi (32K)	4.21	4.84
BCAFPAN	A & F Software Pharaohs Tomb	5.92	6.80	BCBSMUSI	BBSoft Music	7.40	8.50	BCPPROUL	Program Power Roulette for BBC	4.21	4.84
BCAFPAN	A & F Software Pharaohs Tomb	5.92	6.80	BCBSMUSI	BBSoft Music	7.40	8.50	BCPPSEEL	Program Power Seek	5.06	5.82
BCAFPAN	A & F Software Pharaohs Tomb	5.92	6.80	BCBSMUSI	BBSoft Music	7.40	8.50	BCPPSPAC	Program Power Space Jailer (B)	5.14	5.91
BCAFPAN	A & F Software Pharaohs Tomb	5.92	6.80	BCBSMUSI	BBSoft Music	7.40	8.50	BCPPSPAR	Program Power Startrek	4.21	4.84
BCAFPAN	A & F Software Pharaohs Tomb	5.92	6.80	BCBSMUSI	BBSoft Music	7.40	8.50	BCPPSWOO	Program Power Swoop	5.87	6.75
BCAFPAN	A & F Software Pharaohs Tomb	5.92	6.80	BCBSMUSI	BBSoft Music	7.40	8.50	BCPPTIMT	Program Power Timetrek (Star Trek Plus)	5.87	6.75
BCAFPAN	A & F Software Pharaohs Tomb	5.92	6.80	BCBSMUSI	BBSoft Music	7.40	8.50	BCPPWALL	Program Power Wall (B)	4.40	5.08
BCAFPAN	A & F Software Pharaohs Tomb	5.92	6.80	BCBSMUSI	BBSoft Music	7.40	8.50	BCPPWHER	Program Power Where (B)	5.14	5.91
BCAFPAN	A & F Software Pharaohs Tomb	5.92	6.80	BCBSMUSI	BBSoft Music	7.40	8.50	BCPPWHIC	Program Power Whic Salt?	5.14	5.91
BCAFPAN	A & F Software Pharaohs Tomb	5.92	6.80	BCBSMUSI	BBSoft Music	7.40	8.50	BCPPWORL	Program Power World Geography (B)	5.14	5.91
BCAFPAN	A & F Software Pharaohs Tomb	5.92	6.80	BCBSMUSI	BBSoft Music	7.40	8.50	BCPPZARM	Program Power Zarm (B)	5.87	6.75
BCAFPAN	A & F Software Pharaohs Tomb	5.92	6.80	BCBSMUSI	BBSoft Music	7.40	8.50	BCPSSALO	Psion Saloon Sally	4.39	5.08
BCAFPAN	A & F Software Pharaohs Tomb	5.92	6.80	BCBSMUSI	BBSoft Music	7.40	8.50	BCPSVUCA	Psion VU Calc	11.05	12.71
BCAFPAN	A & F Software Pharaohs Tomb	5.92	6.80	BCBSMUSI	BBSoft Music	7.40	8.50	BCPSBEEB	Quicksilva Beeb Art (B)	11.05	12.71
BCAFPAN	A & F Software Pharaohs Tomb	5.92	6.80	BCBSMUSI	BBSoft Music	7.40	8.50	BCQSGENE	Quicksilva Generator (B)	5.13	5.90
BCAFPAN	A & F Software Pharaohs Tomb	5.92	6.80	BCBSMUSI	BBSoft Music	7.40	8.50	BCQSGMUS	Quicksilva Music Processor (B)	11.05	12.71
BCAFPAN	A & F Software Pharaohs Tomb	5.92	6.80	BCBSMUSI	BBSoft Music	7.40	8.50	BCRHGALA	RH Software Galactic Wipeout (RHS001C)	6.61	7.60
BCAFPAN	A & F Software Pharaohs Tomb	5.92	6.80	BCBSMUSI	BBSoft Music	7.40	8.50	BCRHKSKI	RH Software Ski Slalom (RHS002C)	6.61	7.60
BCAFPAN	A & F Software Pharaohs Tomb	5.92	6.80	BCBSMUSI	BBSoft Music	7.40	8.50	BCSHGBLT	Simon W Hessel GB Ltd	5.13	5.90
BCAFPAN	A & F Software Pharaohs Tomb	5.92	6.80	BCBSMUSI	BBSoft Music	7.40	8.50	BCSHINHE	Simon W Hessel Interitance	4.39	5.08
BCAFPAN	A & F Software Pharaohs Tomb	5.92	6.80	BCBSMUSI	BBSoft Music	7.40	8.50	BCSITRAV	Simon W Hessel Travel Game	4.39	5.08
BCAFPAN	A & F Software Pharaohs Tomb	5.92	6.80	BCBSMUSI	BBSoft Music	7.40	8.50	BCSI3DOB	Software Invasion 3D Bomb Alley	5.87	6.75
BCAFPAN	A & F Software Pharaohs Tomb	5.92	6.80	BCBSMUSI	BBSoft Music	7.40	8.50	BCSIATTA	Software Invasion Attack on Alphacenturi	5.87	6.75
BCAFPAN	A & F Software Pharaohs Tomb	5.92	6.80	BCBSMUSI	BBSoft Music	7.40	8.50	BCSIEAGL	Software Invasion Eagles Wing (B)	5.87	6.75
BCAFPAN	A & F Software Pharaohs Tomb	5.92	6.80	BCBSMUSI	BBSoft Music	7.40	8.50	BCSISGUM	Software Invasion Gumsnake	5.87	6.75
BCAFPAN	A & F Software Pharaohs Tomb	5.92	6.80	BCBSMUSI	BBSoft Music	7.40	8.50	BCSISPOO	Software Invasion Spooks & Spiders (B)	5.87	6.75
BCAFPAN	A & F Software Pharaohs Tomb	5.92	6.80	BCBSMUSI	BBSoft Music	7.40	8.50	BCSIVORT	Software Invasion Vortex	5.87	6.75
BCAFPAN	A & F Software Pharaohs Tomb	5.92	6.80	BCBSMUSI	BBSoft Music	7.40	8.50	BCSMDIS	Simonsoft Disassembler	5.87	6.75
BCAFPAN	A & F Software Pharaohs Tomb	5.92	6.80	BCBSMUSI	BBSoft Music	7.40	8.50	BCSS2002	Superior Software 2002	5.87	6.75
BCAFPAN	A & F Software Pharaohs Tomb	5.92	6.80	BCBSMUSI	BBSoft Music	7.40	8.50	BCSSALID	Superior Software Alien Dropout	5.87	6.75
BCAFPAN	A & F Software Pharaohs Tomb	5.92	6.80	BCBSMUSI	BBSoft Music	7.40	8.50	BCSSBATT	Superior Software Battle Tank	5.87	6.75
BCAFPAN	A & F Software Pharaohs Tomb	5.92	6.80	BCBSMUSI	BBSoft Music	7.40	8.50	BCSSCENT	Superior Software Centipede	5.87	6.75
BCAFPAN	A & F Software Pharaohs Tomb	5.92	6.80	BCBSMUSI	BBSoft Music	7.40	8.50	BCSSCOLD	Superior Software Colditz Adventure	5.53	6.30
BCAFPAN	A & F Software Pharaohs Tomb	5.92	6.80	BCBSMUSI	BBSoft Music	7.40	8.50	BCSSCRAZ	Superior Software Crazy Painter	5.87	6.75
BCAFPAN	A & F Software Pharaohs Tomb	5.92	6.80	BCBSMUSI	BBSoft Music	7.40	8.50	BCSSCRIA	Superior Software Cribbage	5.13	5.90
BCAFPAN	A & F Software Pharaohs Tomb	5.92	6.80	BCBSMUSI	BBSoft Music	7.40	8.50	BCSSFAIR	Superior Software Fairground	5.87	6.75
BCAFPAN	A & F Software Pharaohs Tomb	5.92	6.80	BCBSMUSI	BBSoft Music	7.40	8.50	BCSSFROG	Superior Software Frogger	5.87	6.75
BCAFPAN	A & F Software Pharaohs Tomb	5.92	6.80	BCBSMUSI	BBSoft Music	7.40	8.50	BCSSFRUI	Superior Software Fruit Machine	5.87	6.75
BCAFPAN	A & F Software Pharaohs Tomb	5.92	6.80	BCBSMUSI	BBSoft Music	7.40	8.50	BCSSGALA	Superior Software Galaxians	5.87	6.75
BCAFPAN	A & F Software Pharaohs Tomb	5.92	6.80	BCBSMUSI	BBSoft Music	7.40	8.50	BCSSHUNC	Superior Software Hunchback	5.87	6.75
BCAFPAN	A & F Software Pharaohs Tomb	5.92	6.80	BCBSMUSI	BBSoft Music	7.40	8.50	BCSSINVA	Superior Software Invaders	5.87	6.75
BCAFPAN	A & F Software Pharaohs Tomb	5.92	6.80	BCBSMUSI	BBSoft Music	7.40	8.50	BCSSOVER	Superior Software Overdrive	5.87	6.75
BCAFPAN	A & F Software Pharaohs Tomb	5.92	6.80	BCBSMUSI	BBSoft Music	7.40	8.50	BCSSPONT	Superior Software Pontoon	5.13	5.90
BCAFPAN	A & F Software Pharaohs Tomb	5.92	6.80	BCBSMUSI	BBSoft Music	7.40	8.50	BCSSOBER	Superior Software QBert	5.87	6.75
BCAFPAN	A & F Software Pharaohs Tomb	5.92	6.80	BCBSMUSI	BBSoft Music	7.40	8.50	BCSSROAD	Superior Software Road Runner	5.87	6.75
BCAFPAN	A & F Software Pharaoh										

Electronequip

(Authorised BBC Dealer, and service centre)

*** SPECIAL OFFERS**
Mail order only

*** EPSON**

RX-80FT £225.25 + VAT

FX-80 £320.88 + VAT

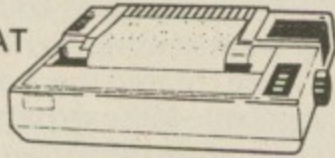

Printer price includes cable for BBC and screen dump rom is available for £11.50

SIDWISE

SIDWISE FITTED

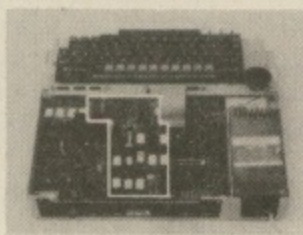
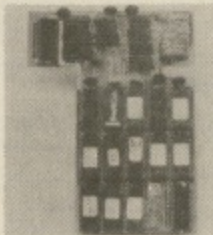

"SIDWAYS" rom board for BBC Micro.
No soldering required £38.00 + VAT

VOLTMACE JOYSTICKS

*** 10% off list prices**



		Discounted price
JSVOLT 14	Voltmace Delta 14B Joysticks	13.46
JSVOLTAD	Voltmace 14B/1 Adaptor Box	13.36
JSVOLT3B	Voltmace Delta 3B Twin Joysticks	18.09

Prices subject to variation without prior notification

TRADE ENQUIRIES WELCOME
Access & Barclaycard Accepted
Large Stocks - 24 Hour Despatch
Carriage 46p

**5 FREE ACORNSOFT
GAMES & CASSETTE
RECORDER WITH EVERY
BBC SOLD** (while stocks last)

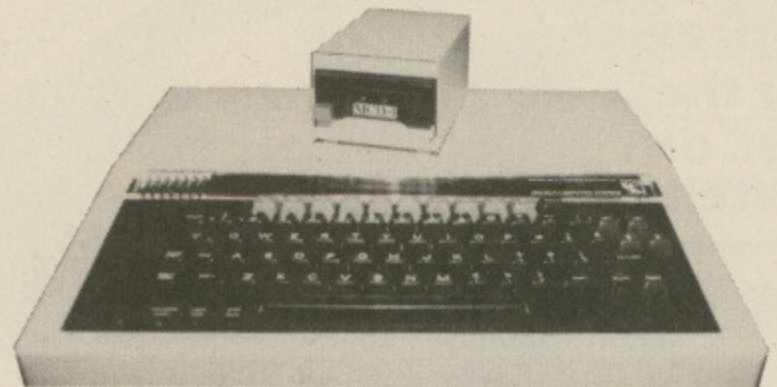

Electronequip is an authorised Acorn service centre and has been an Acorn dealer since the introduction of the Atom. Our demonstration facilities include 20 station Econet and Torchnet systems.

Ref.	BBC Micros	Ex VAT	Inc VAT
ANB01	BBC Model B Micro Computer	348.26	399.00
ANB02	BBC Model B with Econet Interface	389.14	446.00
ANB03	BBC Model B with Disc Interface	409.14	469.00
ANB04	BBC Model B with Disc & Econet Interface	450.01	516.00

3" Micro Disc £129.95
(inc. VAT)

**Disc Interface &
Drive**
£198.95 (inc. VAT)



Micro Disc Drive for the BBC Micro

The Micro disc drive offers a method of low cost quick access to programs. The drive is essentially a small version of a 5¼" disc drive and offers similar features to the larger drive. The data is stored on a 3" disc, this is enclosed in a protective hard plastic cassette which features a write protect switch. The micro drive requires the standard Acorn disc interface, but a new disc filing system rom. Acorn DFS may be exchanged for the micro DFS for £12.00. The new micro disc filing system can read and write to Acorn DFS discs. Thus if a 5½ inch and a micro floppy were connected on the same cable files could be transferred between them.
Capacity: 80.64 K bytes **Transfer Rate:** 125k bit/s.

BRANCHES

FAREHAM: 59 WEST STREET (0329) 230670
KINGS LYNN: 17 TENNYSON AVE. (0553) 3782
MAIL ORDER: 36-38 WEST STREET
FAREHAM, HANTS. (0329) 230670



Electronequip

36-38 West Street, Fareham, Hants (0329) 230670



A little bit of magic from MERLIN COMPUTER PRODUCTS

AN UNBEATABLE COMBINATION! A WORD PROCESSOR
AND DATABASE WHICH CAN BE INTEGRATED.

MERLIN SCRIBE

The first professional
word
processor
for the
BBC disc
system.

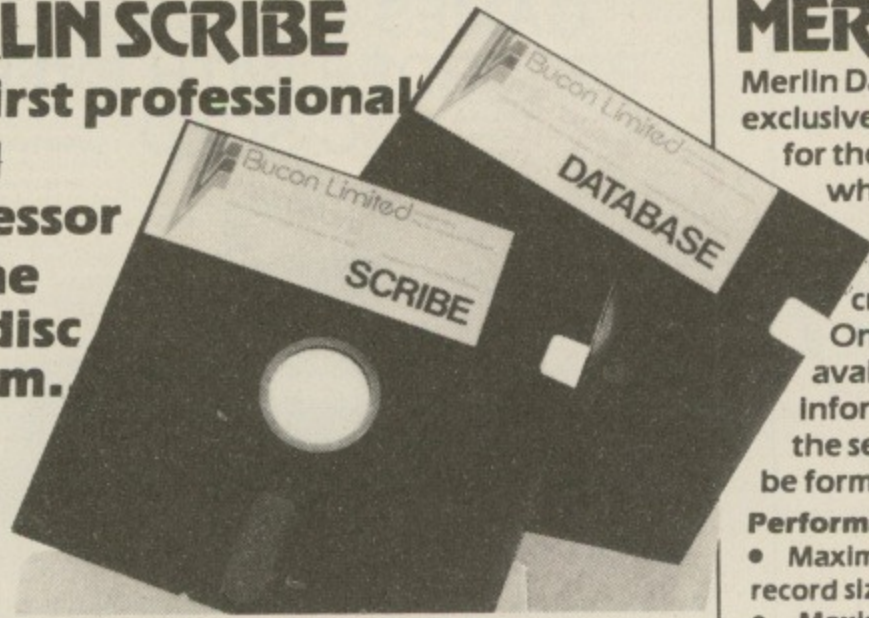

Among the many features available are:

- Create up to 255 pages in a single document.
- Screen user selectable 40 or 80 column with choice of background and text colours.
- Insert text at any page on the document whether currently in memory or not.
- Powerful editing commands:
Move, copy and delete with affected text displayed in reverse video. Will move or copy within a page or to any other page in the document.
- Word search and replace — item by item or globally throughout the document.
- "Go to page" — next and previous using up and down cursor keys or go directly to page numbers
- On screen underlining.
- Format line controls document width and allows setting of right and left margins.
- Tabs set on format line as required.
- Automatic centre and decimal tab.
- Text reformatting.
- Split page and dynamic page break display.
- Word count and display of cursor position by column & line number.
- Will use disc surfaces 0 to 3 as allowed by the BBC system.
- All disc filling operations menu driven, eg. re-name, copy, delete document, compact and catalogue disc, etc. No knowledge of the disc system required.
- Exec document — allows conversion of BASIC programs for editing by word processor and then re-conversion back to either text or program files.
- File merge — one or more documents or other text files may be merged in sequence from any disc drive between 0 and 3.
- Automatic page numbering with page number insertion at any point on the page.
- Headers and footers.
- Total facility print module including selection of serial or parallel output, global printer control codes, page numbering offset, print from page to page, repeat print, etc.
- Selection of up to nine user definable keys for insertion of printer control codes into text, with up to five codes allocated to each key.
- Control number of page display lines for scroll speed increase.

The program comes attractively packaged in a simulated leather grain wallet which contains the manual, disc, chip & function key legend strip.

MERLIN DATABASE

Merlin Database is a database system designed exclusively for the BBC disc based computer. It provides for the structural input of text and numerical data which is stored permanently as a record on the computer. A group of records constitutes a database. Any number of databases may be created using Merlin Database.

Once created there are sophisticated facilities available for searching, selecting and drawing off information from the database by means of defining the search characteristics. This information can then be formatted for producing printed reports, lists etc.

Performance

- Maximum records per database 4000
- Maximum record size 1800 characters
- Maximum no. of fields 32
- Maximum no. of characters for any single field 900
- Find any record in 2 seconds via key field access
- Search every character in a 100 kb database in 29 secs

Field Types

- Numeric — up to 9 digits
- Date
- Sub fields for economic disc usage i.e. specify average & maximum field size

Data Search

- Search results directory held with database on disc
- Data can be passed to mail merge and report writer
- 16 level conditional search
- Search conditions include 'not', '>', '<', '='.
- Wild card
- Database automatically sorted by key field
- Database can be set to re-sort to any alternative set of key fields

Report Writing

- Database will integrate with Merlin Scribe word processor
- Format printer output with simple forms editor
- High powered forms layout & editing using Scribe (alls. rt. justify)
- Arithmetic calculations & accumulators
- Conditional report writing
- Semi programming facility for forms & report generation

Other Facilities

- Mail merge using Scribe
- Conditional mail merge
- Automatic reformatting of lines
- Capable of conditional transfer of information between databases.

Database comes in chip with manual, simple fitting instructions & systems disc. Also planned is the production of Database integrated with the Merlin Scribe word processor in a single chip although the database is designed to integrate easily with Scribe in a separate chip.

MERLIN DATABASE £49.00
MERLIN SCRIBE £59.95
MERLIN SCRIBE/DATABASE £95.00

Prices include VAT. Price and specification subject to change without prior notice.

Credit card orders accepted. Special discounts for educational establishments and dealers.

MERLIN COMPUTER PRODUCTS (BUCON LTD)
35/36 SINGLETON STREET, SWANSEA SA1 3QN
Tel: (0792) 467980 (3 lines)



PETER JOHNSON describes the new assembly instructions available on the second processor

How to save both time and memory

THERE are two obvious ways in which Acorn's new 6502 second processor gives the user more power. The first is its extra speed – the clock rate is 3MHz compared with the 2MHz of the I/O processor (the BBC Micro).

In addition, the second processor is interrupted far less frequently than the I/O processor as it has no keyboard or other devices to service. These factors result in a speed increase of 50-65 per cent.

The other powerful feature is the extra memory the second processor provides. There is 44k available to the Basic programmer when HiBasic is used and 60k available to machine code programmers.

There is also a less well-known extra that the second processor gives – an enhanced instruction set.

The 6502 used in the parasite (another name for the second processor) is not the common or garden NMOS version used in the host (another name for the BBC Micro!), but a souped-up CMOS version made by, among others, GTE.

The official designation for this chip is G65SC02, though there are other similar ones such as the 65SC12 which have the same instruction set but slightly different hardware characteristics.

The purpose of this series of articles is twofold. Firstly, it introduces the new 65SC02 instructions, explaining how they save bytes and microseconds.

Secondly it explains a way of assembling the new instructions using the HiBasic assembler directives.

I assume that the reader has a fairly good knowledge of the standard 6502, so I won't attempt to teach assembly

language programming.

Table I summarises the new instructions.

I have grouped the extra 65C02 instructions into eight sets of similar operations, or address modes, for the purpose of explanation.

Before I start with a detailed description of the 27 instructions listed in Table I, it should be noted that there are another 32 instructions available on the Rockwell R65C02 family of chips that do not appear in the instruction set of the 65C02.

Acorn seems to have chosen the latter chip instead of the more powerful Rockwell version because it is more easily available. Whereas several companies manufacture the 65SC02, Rockwell is the only source of R65C02 chips. It's nice to see that Acorn has learnt a lesson from the scarcity of 8271 disc controllers, whose sole supplier is Intel.

It can be seen from Table I that the 65C02 instructions provide both new operations and extensions of existing ones. I will describe the new opcodes by group – the first four this month, the last four next month.

Group 1

This comprises eight existing instructions using a new addressing mode. This mode is zero page indirect and has previously been available only with some form of indexing.

Readers familiar with the standard 6502 instructions will notice that the eight instructions provided with zero page indirect are the same ones that currently allow post-indexed and pre-

Start of a new
3-part series

SECOND
PROCESSOR

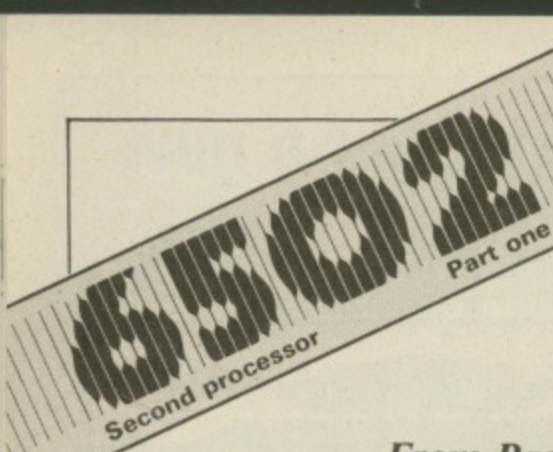

From Page 63

indexed indirect modes.

With zero page indirect, the required byte is found at the address given by two zero page bytes. The location of the first of these zero-page bytes is given in the operand of the instruction. This sounds complicated, but compare the two sequences given below – they have the same effect:

6502 LDY#0 LDA (tmp),Y	65C02 LDA (tmp)
------------------------------	--------------------

In both versions *tmp* is the address in zero page of the pointer to the (address of) the desired byte. On the BBC running under Basic, *tmp* might have the value &70, as that is where the user's workspace starts.

At *tmp* and *tmp+1* there would be the address of the byte to be loaded. It can be seen that by using the new instruction, two bytes of program – required by the LDY#0 – have been saved. Moreover the Y register wasn't corrupted, and two clock cycles were saved.

Group 2

A fairly small group this, containing only one instruction. Incredibly, the designers of the original 6502 instruction set didn't include an unconditional branch instruction.

This was unfortunate as it meant that 6502 programmers either had to use JMP, which is one byte longer, or branch on some condition that they knew to be true. If no such condition could be assumed, one was often invented. For example:

6502 CLC BCC label	65C02 BRA label
--------------------------	--------------------

In the first example the CLC was executed solely in order to make the branch succeed. In the 65C02 version the branch is executed without regard to the condition codes.

The advantage of this is that code can be made clearer by having explicitly unconditional branches, rather than inventing some contrived "always true" condition.

Like the rest of the branch

instructions, the operand of BRA is a single byte which gives the displacement of the destination from the first byte of the next instruction.

This displacement is in the range -128 to 127, or -126 to 129 bytes from the branch instruction itself. A BRA &FE instruction will cause an infinite loop, and BRA 0 is effectively a NOP instruction.

Group 3

This adds new address modes to an existing instruction. The action of BIT is to AND its operand with the accum-

ulator, setting the zero (Z) flag if the result is zero.

The accumulator is not affected. In addition, the negative (N) flag is set to the sign (most significant) bit of the operand, and the overflow (V) flag is set to the second most significant bit (bit 6, counting from zero) of the operand.

Usually the ANDing part of the instruction is ignored, and BIT is used to test the state of the top two bits of its operand. Out of interest, you may like to look at the possible values of A when the

Mnemonic	Operation	NVZC	Opcode	Bytes	Cycles
Group 1					
ORA (zp)	A=A OR M	N . Z .	&12	2	5
AND (zp)	A=A AND M	N . Z .	&32	2	5
EOR (zp)	A=A EOR M	N . Z .	&52	2	5
ADC (zp)	A=A+M+C	NVZC	&72	2	5
STA (zp)	M=A	&92	2	5
LDA (zp)	A=M	N . Z .	&B2	2	5
CMP (zp)	A-M	N . ZC	&D2	2	5
SBC (zp)	A=A-M-~C	NVZC	&F2	2	5
Group 2					
BRA rel	Branch by M	&80	2	3
Group 3					
BIT zp,X	A AND M	76 . Z	&34	2	4
BIT abs,X	A AND M	76 . Z	&3C	3	4
BIT imm	A AND M	76 . Z	&89	2	2
Group 4					
STZ zp	M=0	&64	2	3
STZ zp,X	M=0	&74	2	4
STZ abs	M=0	&9C	3	4
STZ abs,X	M=0	&9E	3	5
Group 5					
INC A	A=A+1	N . Z .	&1A	1	2
DEC A	A=A-1	N . Z .	&3A	1	2
Group 6					
PHY	Stk=Y Sp=Sp-1	&5A	1	3
PHX	Stk=X Sp=Sp-1	&DA	1	3
PLY	Sp=Sp+1 Y=Stk	&7A	1	4
PLX	Sp=Sp+1 X=Stk	&FA	1	4
Group 7					
JMP (abs,X)	PC=M	&7C	3	6
Group 8					
TSB zp	M=A OR M	N . Z .	&04	2	5
TSB abs	M=A OR M	N . Z .	&0C	3	6
TRB zp	M=~A AND M	N . Z .	&14	2	5
TRB abs	M=~A AND M	N . Z .	&1C	3	6

Table 1

M is the memory location addressed by the operand
 X and Y are the 65C02 registers
 Sp is the 65C02 stack pointer
 Stk is the address &100+Sp
 ~A means NOT A, ~C means NOT (the carry flag)
 NVZC means that flag is affected, . means it isn't
 7 means N is set to bit 7 the operand
 6 means V is set to bit 6 of the operand

SYSTEME
 ADVAN
 IBM com
 2 x 320K
 Perfect V
 Perfect
 plus 12 r
 (monitor
 SANYO
 80% IBM
 2 x 160K
 Mailmen
 Limited
 available
 (Monito
 ELEC
 Includes
 BBC-
 Includes
 Softwar
 PRINT
 Brother
 Juki Da
 Daisyst
 EPSON
 EPSON
 Includin
 ORI
 Produ
 SENI
 TOTA
 ALL I
 MANI

SYSTEMS



ADVANCE 86
 IBM compatible, 128K RAM,
 2 x 320K Drives. Price includes:
 Perfect Writer, Perfect Speller,
 Perfect Filer and Perfect Calc,
 plus 12 months on site warranty
 (monitor available at extra cost).

£1437

SANYO 555
 80% IBM compatible, 128K RAM,
 2 x 160K Drives. Price includes: Wordstar,
 Mailmerge, Info-Star and Calc-Star.
 Limited number of SAGE Accounts still
 available.
 (Monitor available at extra cost) £1148



ELECTRON £199

Includes free software tape

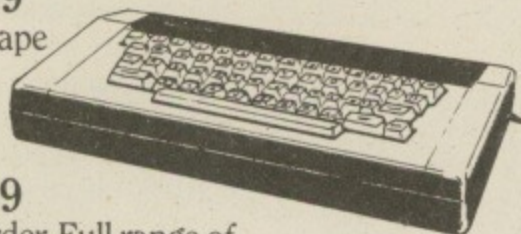

BBC-B £399

Includes free tape recorder. Full range of
 Software and Disk Drives available.

PRINTERS

- Brother Printer HR 15 £399
- Juki Daisywheel 6100 £389
- Daisystep £295
- EPSON RX80 FT £299
- EPSON FX80 £389

Including lead for BBC.

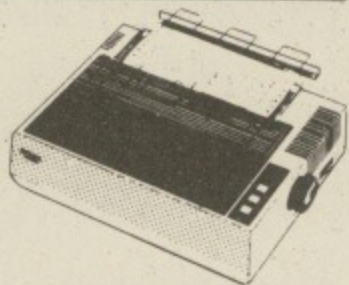

DISKETTES

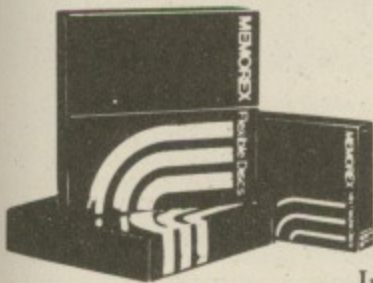

- Memorex, in packs of 10
- SS 40tk.....£18.00
 - DS 40tk.....£23.00
 - SS 80tk.....£26.00
 - DS 80tk.....£29.00

Including VAT, p&p.

Stay tuned to Microware for further discounts

EPSON DISK DRIVES

200K-400K-800K
 plus new 3 1/2" range
 (including manual 8 formatter)

- 100k single unit £139
- 100k dual unit £229
- 200k single unit £195
- 200k dual unit £325
- 400k single unit £225
- 400k dual unit £349
- Switchable £375

UDM DDFS £95

MONITORS

- Microvitec colour
- Normal res. £199
- Medium res. £299
- High res. £399
- Sanyo/BMC 12" C £110

Call for our full price list.

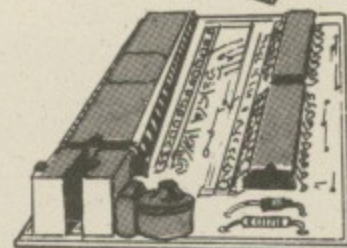
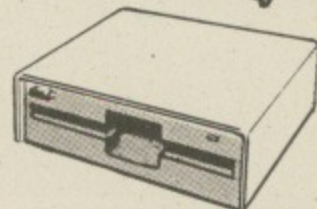
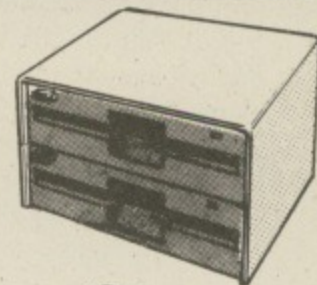

ACCESSORIES

- BBC Stands.....£15.00
- Dust covers.....£5.60
 (for BBC,
 Drives and
 Printers)



ORDER FORM

Product	Price	Qty.	Total
_____	_____	_____	£_____
_____	_____	_____	£_____
_____	_____	_____	£_____
_____	_____	_____	£_____
_____	_____	_____	£_____
_____	_____	_____	£_____
_____	_____	_____	£_____
_____	_____	_____	£_____

SEND DETAILS ON _____
 TOTAL SUM ENCLOSED (Cheque or credit card no.) £ _____
 ALL PRODUCTS ARE BRAND NEW, BOXED AND OFFERED WITH FULL
 MANUFACTURERS WARRANTY. All prices include VAT & delivery

MICROWARE

14 Charles Street Hanley Stoke-on-Trent
 (0782) 269 883
 67 Westow St. Upper Norwood London SE19
 01-771 5123
 637 Holloway Road London N19 5SS
 01-272 6398

I enclose my order for the above products.

Name _____

Address _____

Signed _____

From Page 64

OSFIND routine is called.

The values were obviously chosen to make it easy to test the required file type using BIT. Similarly ROM-type bytes use bits 6 and 7.

The 65C02 enhancements to BIT provide three new addressing modes which are already available on other instructions. The first two simply add an index to the existing BIT address modes. This could be useful, for example, when checking a table of flags, looking for one with bit 6 and bit 7 set:

	65C02					
	LDX#&0F	Check 16 entries	.next	DEX	Do next one	
.loop	BIT table,X	Check current byte		BPL loop	If we haven't passed zero	
	BPL next	Not this one	.fail	\	Print some kind of "Not found" message	
	BVS found	Got a byte with Z=1, V=1	.found	\	We come here with X pointing at the entry if found.	

In this example *table* could be either a zero page location, in which case the instruction would take two bytes and four cycles, or an absolute location, taking three bytes and 4/5 cycles.

The last new BIT instruction, BIT immediate, has the operand following the opcode. A typical use would be to set the sign or overflow flags without altering any of the registers. For example, BIT#&C0 would set both the flags, and BIT#&40 would set just the overflow flag. The ANDing action to set the zero flag still takes place, of course.

Unfortunately there is a bug in the 65SC02 – the BIT immediate instruction does not set the sign or overflow flags correctly. Its use in this way should therefore be avoided.

Group 4

The store zero instructions are very useful. They set the contents of their operand address to zero. An alternative mnemonic is CLR, which is the one used for a similar instruction on the Motorola 6800.

The zero page and absolute versions obviously affect one location. The two sequences:

6502	65C02
LDA#0	STZ total
STA total	

have similar effects. The 65C02 version has the advantage that it doesn't affect the accumulator or flags, is two bytes shorter and is two cycles quicker.

Similar advantages apply to the indexed versions. These may be used to clear up to 256 locations, with the advantage that the accumulator may be used in the loop for things other than holding the constant zero.

● Peter Johnson continues his assessment of the 65C02 instruction set in next month's issue of *The Micro User*.



ADD 40 COMMANDS TO BBC BASIC WITH ONE ROM

GRAPHICS

SCALE is a powerful and totally flexible statement that allows the user to take control of the scaling of the screen. Integers, real numbers and variables can be used.

ROTATE is used to 'rotate' the axes about a point and by an angle both defined by the ROTATE statement on a scaled screen.

CIRCLE and **ELLIPSE** allow a multitude of shapes to be drawn using a single statement, including:- any regular polygon, circles, arcs, solid sectors, triangles, squares, etc.

FILL is used to 'fill' a previously drawn area, with CFILL setting the colour/pattern/shade within pre-drawn bounds.

TRANS is used to translate the scaled area across the screen by the use of cartesian co-ordinates, subsequent graphics commands making use of the now displaced scaled area.

Plus: SMOVE, SDRAW, SPLOT and UNSCALE.

4
IN
1

GENERAL

LLIST can be programmed, unlike LIST, and under the user's control, multiple statement lines can be split up into their component parts allowing for greater ease of reading.

LGOTO is similar to the GOTO statement but more powerful in that it enables the user to jump to 'labelled lines' allowing for neater and more readable programmes.

SORT allows the user to sort all or part of a string array into alphabetical order using single statement. Invaluable for data processing.

SETWIN and **WIN** allows the user to define, using SETWIN, and display, using WIN up to seven complete windows on the screen. The user being able to select and return to previously de-selected windows at will, the cursor maintaining its last used position within that window.

Plus: OPT, POPFOR, POPGOS, POPREP and ADDCOMM

Compatible with: Acorn DFS, Amcom(Pace) DFS, Watford DFS, Wordwise, Disc Doctor, Model B, BASIC 1 or 2, OS 1.20

ADDCOMM

Plus: *HELP displays the full syntax of all commands. Price includes a detailed ring-bound User Guide.

Now available for Electron with Rom board

LOGO

LMOVE is used to position the LOGO cursor, usually used prior to further LOGO statements.

ANGLE is used to set the intended direction of the LOGO cursor, the angle being described in degrees.

ADVANCE is used to move the cursor in the direction as set by ANGLE by the distance described in the ADVANCE statement.

TURN gives the cursor a new direction by turning it a certain number of degrees anti-clockwise from its previous direction.

PEN defines the kind of trail left by the LOGO turtle using the internal plot codes.

LCIRCLE and **LELLIPSE** are the LOGO equivalents of the similar enhanced graphics commands, the shape centre being the current LOGO cursor position.

LPOS is used to return the position of the LOGO cursor from a SCALED screen.

£28
includes VAT, post and packing

FOOLKIT

CHAR is a simplified 'character' designing facility using an enlarged grid that enables the user to quickly and easily construct or alter graphic and pseudo-alphanumeric characters.

COMPACT is used to reduce the size of all or part of an existing program by intelligently appending lines together.

FIND is used to search all or part of a program to find any desired character or set of characters.

GREPL and **SREPL** are two related commands that enable the user to replace a character or group of characters with any other character or group of characters, under total control of user.

LVAR is used to list all, or alphabetically selected, variable names currently within memory.

VERIFY is a simple command to confirm that a copy to tape or disc is exactly the same as the original program in memory.

Plus: MEM, GOODPROG, KILLREM and FKEYS.

These commands are unlike those on any other ROM, since they are used in exactly the same way as the standard BASIC commands:- i.e. any numeric/string expression, multi-line statements, access to any variable, and of course, no stars!



Available now from:

VINE MICROS, MARSHBOROUGH, SANDWICH, KENT. CT13 0PG.

(Or send stamp for Brochure.)

One name stands out for quality and value



When you choose a TAXAN monitor from Kaga, whether it's monochrome or RGB colour, you're choosing the best.

COMPATIBILITY

TAXAN monitors are compatible with all popular micro computers. Apple™, Acorn/BBC™, IBM™, Commodore™, Oric™, Dragon™, Research Machines™, Osborne™, Tandy™, Sinclair™ (with interface) – you name it, KAGA TAXAN's made for it.

COLOUR RANGE

There are several TAXAN Colour Monitors available from around £200 to £399, including:-

VISION EX (Resolution: 380 dots) – PAL or RGB input – Built-in Speaker – Equipped with smoked filter – Ideal display for Computers and/or Video Recorders.

VISION II (Resolution: 510 dots) – RGB Colour Display – Capable of 80 column display – Equipped with smoked filter – Built-in switchable interface.

VISION III (Resolution: 640 dots) – RGB Colour Display – Suitable for 80 column display – Utilises latest matt black non-glare tube – Built-in switchable interface.

VISION PC – IBM compatible version of the Vision III in 'IBM style' casing.

MONOCHROME RANGE

NEW: THE KX SERIES of monochrome monitors from around £100 – 12" non-glare flat screen – Green or Amber display – More than 20 MHz – Built-in handle – Optional 'tilt and swivel' stand – IBM PC™ compatible versions available.

RELIABILITY

TAXAN monitors are among the most reliable displays around, and are backed by a full 12 months' warranty.

TAXAN IS THE NEW BRAND NAME FOR PRODUCTS MANUFACTURED BY KAGA ELECTRONICS CO. LTD.

All prices ex-VAT and correct at time of going to press.

NLQ DOT MATRIX PRINTERS

NEW

TAXAN
 KP810 (£299)
 (80 col. model)
 KP910 (£399)
 (156 col. model)
 – 140 cps and near-letter quality (NLQ) print.
 – Supported by all popular software.
 – High resolution graphics.

RING 0442 60155 FOR DETAILS

TRADE AND OEM ENQUIRIES WELCOME.

Available from your local computer dealer; selected branches of W.H. Smith, Lasky's, Curry's and other leading retailers. EXCLUSIVE UK DISTRIBUTOR.

DE
Data Efficiency Ltd

Whatever your system... insist on KAGA TAXAN

Computer Peripherals Division. Maxted Road, Hemel Hempstead, Herts. HP2 7LE Tel: (0442) 60155 (14 lines) Telex: 825554 DATEFF G

LVL COMPUTERTOWN

Whether its your first computer or whether you're already an enthusiast, LVL COMPUTERTOWN offers you the quality of service you expect from experts. If you invest money, you go to a bank or a broker - a specialist who can guide and advise you on the best return for your capital. At LVL COMPUTERTOWN we're specialists too. We're there to help guide you through the micro maze, keep you up to date on innovations, help you get the best value for money, whether your computer is for you, your children or your business. Your computer can change your life - make sure you change it for the better: Come and talk to the experts and move into micros with LVL COMPUTERTOWN

PRINTERS

NEC PC-8023-N Dot-Matrix Printer.
Economical all purpose printing for your computer.



£228.85

- Centronics-compatible parallel interface.
- Bidirectional logical seek operation for high speed printing (120cps).
- Output to printer can be on character-by-character or even dot-by-dot basis.
- Many character sizes; fan fold and single-single sheet paper.
- Automatic reversal of ribbon gives clear, crisp impressions for a long period of time.

COMPUTERS

BBC MICROCOMPUTER



Model B	£399
Model B with ECONET	£446
Model B with DOS	£469
Model B with DOS & ECONET	£516



£199.00

The new personal computer from Acorn Computers. An ideal machine for learning computing — and for having a lot of fun at the same time. But it's much more than just a toy. It's graphic facilities are the most sophisticated available in it's price range.

MONITORS

Fitted with the Euro-Standard connection. The SABA combines: input and output for video and audio, RGB inputs and this direct control of the colour tube (that is to say absolutely lossfree direct input of the picture signal) makes the SABA ideal for all video recorder standard video text, video games and home computers. SABA is among the very few manufactures providing this advanced universal connection — giving you the best of both worlds — Colour monitor and Colour TV



£246.85

SABA 14" Colour Monitor/Colour TV.

DATA RECORDERS



£39.95

A REFLECTION OF SUPERIORITY

- The Bell & Howell/LVL Computer Compatible Data Recorder
- Automatic Level Control
 - Automatic Tape Stop
 - Tape Counter
 - Remote Motor Control

DISK DRIVES



An example of superior technology, reliability and outstanding performance combine to produce the LVL Disk Drive Family. Truly professional units designed to work with the BBC Microcomputer.

PRICES START FROM £179.57

JOY
British Ma
profession
than total
joystick o
Acornsoft

● 12 mon
● Fully co
model
A/D in
port.

SO

at your loc
or most p

The iter
product
stock.
Howeve
before r

For furth
nearest

JOYSTICKS

British Made and fully guaranteed, the LVL twin joysticks are professional units with which your aim should be nothing less than total control. They will operate any programmes that have a joystick option and are written in a way that is compatible with Acornsoft.



£21.95

- 12 months guarantee
- Fully compatible with the BBC model 'B' or 'A' fitted with an A/D interface and an analogue port.
- Nylon encased-steel shafted joysticks with ball and socket joint
- Fast spring return to centre
- Graphite wiper linear potentiometers

SOFTWARE

At your local COMPUTERTOWN Dealer you'll find hundreds of titles. For most popular home computers, offered at prices and skill levels to suit all your desires. To avoid disappointment please telephone your local stockist for a full availability and price list.



ALL PRICES
INCLUDE
VAT.

The items featured represent a very small selection from our vast product range, and at the time of going to press were all available from stock. However, not all dealers carry every advertised item, please telephone before making your journey.

For further details, and full product literature pack call or telephone your nearest LVL Computertown Dealer.

CHESHIRE

C. TECH SOFTWARE
184 Market St.
HYDE
Cheshire
061 366 8223

CUMBRIA

THE COMPUTER SHOP
56/58 Lowther St.
CARLISLE
Cumbria
0228 27710

ESSEX

A.C.L.
1 Northmall
GRAYS, ESSEX
0375 79834

BROADWAY MUSIC
AND VISION
Woodford Green
ESSEX
01 504 7500

GREATER MANCHESTER

LOMAX
8 Exchange St.
St. Annes Square.
MANCHESTER
061 832 6167
* Home & Business
Computers Ltd.
54, Yorkshire Street,
OLDHAM
061 633 1608

WORC'S

SPURTREE COMPUTING
LTD.
Council Buildings
Teme Street
TENBURY WELLS,
Worcestershire
0584 81153/811304

MERSEYSIDE

THORNGUARD
46, Pensby Rd.
HESWALL
The Wirral
Merseyside
051 342 7516

NOTTS'

S P ELECTRONICS
48, Linby Rd
HUCKNALL
Notts.
0602 640377
COMPUTERTOWN (UK) LTD.
230, Derby Rd.
STAPLEFORD
Notts.
0602 399484

OXFORD

ABSOLUTE SOUND
AND VIDEO (Oxford) Ltd.
19, Old High St. Headington
OXFORD
0865 65961

AVON

K & K COMPUTERS
32, Alfreds St.
**WESTON
SUPER MARE**
Avon
0934 419324

COLSTON COMPUTER
CENTRE LTD.
The Colston Centre,
11, Colston Ave.
BRISTOL
0272 276619

YORKSHIRE

HOME & BUSINESS COMPUTERS
59, Daisy Hill
DEWSBURY
Yorks
0924 455300

BUCKS'

HI-VU ELECTRONICS
38, Church St. Wolverton
MILTON KEYNES
Bedford
0908 312808

SUSSEX

C.J.E. MICROS
78, Brighton Rd.
WORTHING
West Sussex
0903 213900

W MIDLANDS

JBC MICRO SERVICES
200, Earlsdon Ave.
Nth. Earlsdon
COVENTRY
0203 73813

WILTSHIRE

WILTSHIRE MICRO CENTRE
Unit 6, Central Trading Estate,
Signal Way,
Old Town,
SWINDON
0793 612299

YOUR
LOCAL



DEALER

HEREFORD

KEMPSONS
26, St. Owen St.,
HEREFORD
0432 273480

KENT

KENT MICRO
57, Union St
MAIDSTONE
Kent
0622 52784

LEICESTER

PERCY LORD & SON
63, Blaby Rd
WIGSTON
Leicester
0533 785033

LONDON

CANNONBURY RADIO
185, Upper St
ISLINGTON NI
London
01 226 9392

PAUL ELECTRICAL
250/2 Grand Drive,
Raines Park,
LONDON SW20
01 542 6546

WOODS RADIO
257, Lavender Hill,
Battersea,
LONDON
01 228 1768

SALOP

MEDLICOTT BROS.
53, Mardol
SHREWSBURY
SHROPSHIRE
0743 3060

NORTH'LAND

NEWTONS
Main St,
SEAHOUSES
0665 720307

STAFFS

J W BAGNALL
18, Salter St.,
STAFFORD
0785 3420

SURREY

* HASLEMERE COMPS
25, Junction Place,
HASLEMERE
Surrey
0428 53850

P & H ELECTRONICS
5, The Parade,
Reading Rd,
YATELEY
Surrey,
0252 877 222

ISLE OF WIGHT

EXCELL
4, Foreland Rd.
BEMBRIDGE
Isle of Wight
098 387 2578

LANCASHIRE

* P V MICROS
38A Water St.
ACCRRINGTON
Lancs
0254 36521

Home & Business
Computers (RCH) Ltd.
73, Yorkshire Street,
ROCHDALE
0706 344654

WALES

S.I.R.
91, Whitchurch Rd.
Cyncoed
CARDIFF
Wales
0222 621813

THE COMPUTER SHOP
41, The Hayes,
CARDIFF,
Wales.
0222 26666

SCOTLAND

COMMSCOT
30 Gordon St.
GLASGOW
041 2264878

- The complete AMS disc drive package, tailored to your BBC micro, is compatible with all disc interfaces and includes cables, a comprehensive manual and utilities on either disc or EPROM. Housed in a steel case, matching the BBC micro, these reliable and robust Hitachi 3" disc drives are the ultimate for home, office and classroom.
- The 3" disc is totally enclosed in rigid plastic and a unique automatic steel shutter protects the delicate disc surface from dust and finger marks. For the first time discs can be used in industrial, educational and commercial environments without the worry of corrupting precious programs and data.
- The disc is "flippable" like a cassette tape and has a storage capacity of 100K on each side in single density mode (twice as much when used with a double density interface). A neat plastic switch can be flicked back and forth to write-protect valuable discs.
- The AMS disc drives are completely hardware and software compatible with 5 1/4" drives which can be used in parallel so allowing easy transfer of software. Consequently the 3" drives will operate with all the standard floppy disc interfaces. They take their power from the outlet provided by the BBC micro - there's no onboard power supply to corrupt data.
- The AMS package includes utilities on either disc or EPROM for formatting and verifying discs. The EPROM, which is easily fitted, offers a simple to use and permanent alternative to using the utilities disc.
- The impressively engineered Hitachi 3" drives feature an eject button allowing single handed operation, a multi-colour LED indicating the disc side in use, and brushless direct-drive motor for reliable operation. The super fast track-to-track access time of 3ms is at the forefront of disc drive technology. The longest of programs are loaded in a flash.

Advance with AMS

3" Disc Drives - The Ultimate Choice

All units include REPLICA II tape to disc software free of charge.

STOP PRESS
 Double Sided Head
 Non-flippable disc
 Single £199
 Double £395
 includes VAT and delivery

Recommended Retail Price
Single 200K - £169

(100K per side)

Double 400K - £335

(200K per disc)

includes VAT and delivery



Direct Delivery

If not available from one of our 200+ dealers fill in the coupon and we will deliver your order promptly.
 Advanced Memory Systems Ltd, Green Lane, Appleton, Warrington WA4 5NG
 RING (0925) 62907 OR 62682

TO: Advanced Memory Systems, Ltd, Woodside Technology Centre, Green Lane, Appleton, Warrington Cheshire WA4 5NG.

Please send me:

- Qty AMS-3 (S) single disc drive all inclusive package at £169 each
- Qty AMS-3 (T) twin disc drives all inclusive package at £335 each.

Prices include utility disc, cables, manual, VAT and delivery.

Please send me by post, if not with drives:

- Qty double sided (100K x 2) discs at £4.95 each.
- Qty packs of five at £22.50 per pack.
- Qty Formatting and Verification Utility EPROM £17.25

I enclose a cheque for £ or debit my credit card

No.

Name

Address

Post Code Tel No

Signature Date

A val
 Sig
 (a
 su
 an

IN Nur
 simple
 cation a
 The p
 in place
 child is
 symbol
 comput
 give the
 If the
 the sco
 up to a
 The
 compu
 mather
 require
 How
 the pro
 The
 also in
 when
 haven't
 progra

WHICH

 Hitachi - in a word reliability

are and
can be
f software
h all the
heir power
there's no

er disc or
The
le to use
ties disc.

ves feature
ation, a
use, and a
eration.
3ms is at
ngest of

IS

Price
£169

£335

livery

A valuable maths exercise by PALI RAO

Sign of the times (and addition, subtraction and division)

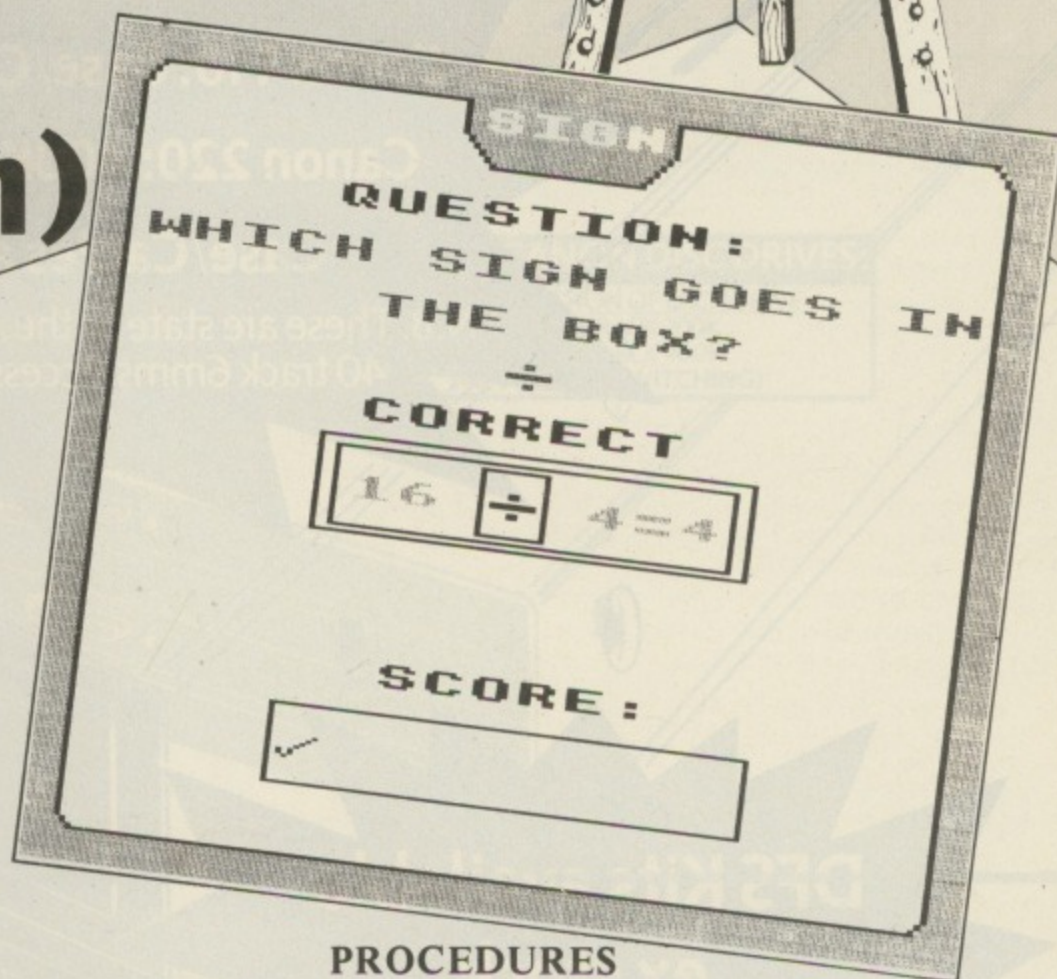

IN *Number Signs* a child is tested on simple subtraction, addition, multiplication and division.

The program prints a sum with a box in place of the correct sign and then the child is asked to enter the correct symbol. If the child is wrong, the computer will tell him or her and also give the correct symbol.

If the question is answered correctly the score is incremented by one, adding up to a total out of 10.

The program uses the normal computer symbols *, /, -, + for the mathematical functions, even where this requires the use of the Shift key.

However if the child fails to use Shift, the program will prompt accordingly.

The program uses Modes 7 and 2 and also involves the speech synthesiser when entering the name. But if you haven't got such a modification the program will still run normally.

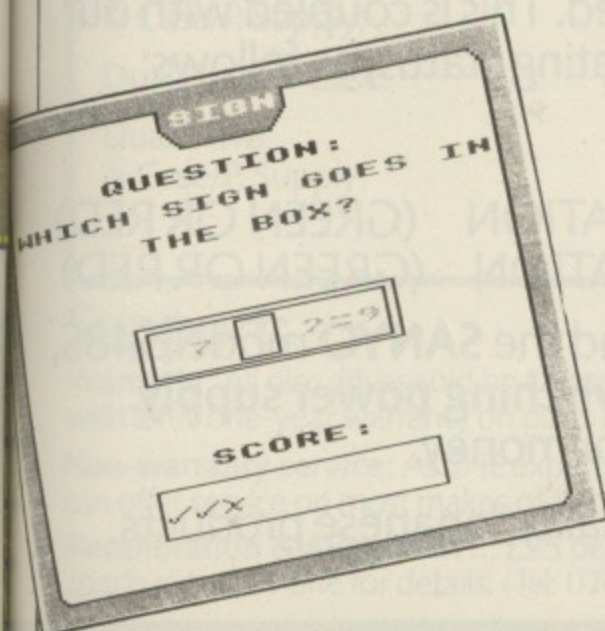

PROCEDURES

- | | |
|--------------------|--|
| PROCinit | Initialises variables and also sets up the user defined characters. |
| PROCinstr | Prints out the instructions and explains the keys to be used. |
| PROCtune | Plays a short tune and then causes a delay while the tune is being played. |
| PROCname | This procedure from <i>The Micro User</i> asks the user for his/her name. The speech synthesiser also asks the user but this will not have any effect if not fitted. |
| PROCcalc | Calculates the values for the equation. |
| PROCscreen | Sets up the screen, draws a border and box. |
| PROCbox | Draws the box in place of the numeric symbol. |
| PROCmessage | Informs the user whether the symbol was correctly input or not and also prints out the correct symbol if necessary. |
| PROCscore | Tells the user the score obtained and gives an encouraging message depending on the score. This procedure also asks the user if the game is to be played again. |

VARIABLES

- | | |
|--------------|---|
| TES | Name of the player. |
| X%,Y% | Position of sum on screen. |
| SX,SY | Position of tick/cross. |
| BX,BY | Position of box on screen. |
| delay | Delay period for PROCdelay (a simple loop). |
| SC | User's score. |
| A,B | Random elements in the sum. |
| C | True result of the sum. |
| AS | Holds user defined symbols for -, +, ÷, × |

Listing starts
on Page 147

CHASE DATA L

PRICES SENSATION

Canon 110: Case/Cables all INCL **£99**

Canon 220: 400K (40/80 switching)

Case/Cables all INCL **£169**

N.B. These are state of the Art Disc Drives; Direct Drive
40 track 6mms Access/80 track 3ms Access.

**DFS Kits available
ex stock
all inclusive price £109**

SLIM CANON DISC DRIVES:	
MODEL:	SPECIFICATION OF EACH DRIVE
110	S/SIDED 40 TRACK 100K
210	D/SIDED 40 TRACK 200K
220	D/SIDED 80 TRACK 400K (40/80 TRACK SWITCHING)

■ All **CANON** 40/80 switchable disc drives feature an on-board dual-colour LED on the front panel to show track mode selected. This is coupled with our own unique two-stage illumination, to give a clear operating status, as follows:

40 TRACK MODE: _____ LED GREEN

80 TRACK MODE: _____ LED RED

POWER ON: _____ HALF-ILLUMINATION (GREEN OR RED)

DRIVE SELECTED _____ FULL-ILLUMINATION (GREEN OR RED)

■ Super-slim **CANON** drives, models 211 and 221 and the **SANYO** model 548S, are available with their own **custom-built secondary switching power supply**. This is safe, low in heat generation and excellent value for money.

■ The **SANYO** disc drive is our latest acquisition in quality Japanese products. This is a "half-height" unit of standard dimensions.

CHASE DATA LTD DISC DRIVES

**FOR THE
BBC
MICRO**

SLIM SANYO DISC DRIVES:

MODEL: SPECIFICATION OF EACH DRIVE
548S S/SIDED 40 TRACK 100K

SUPER-SLIM CANON DISC DRIVES:

MODEL: SPECIFICATION OF EACH DRIVE
211 D/SIDED 40 TRACK 200K
221 D/SIDED 80 TRACK 400K
(40/80 TRACK SWITCHING)

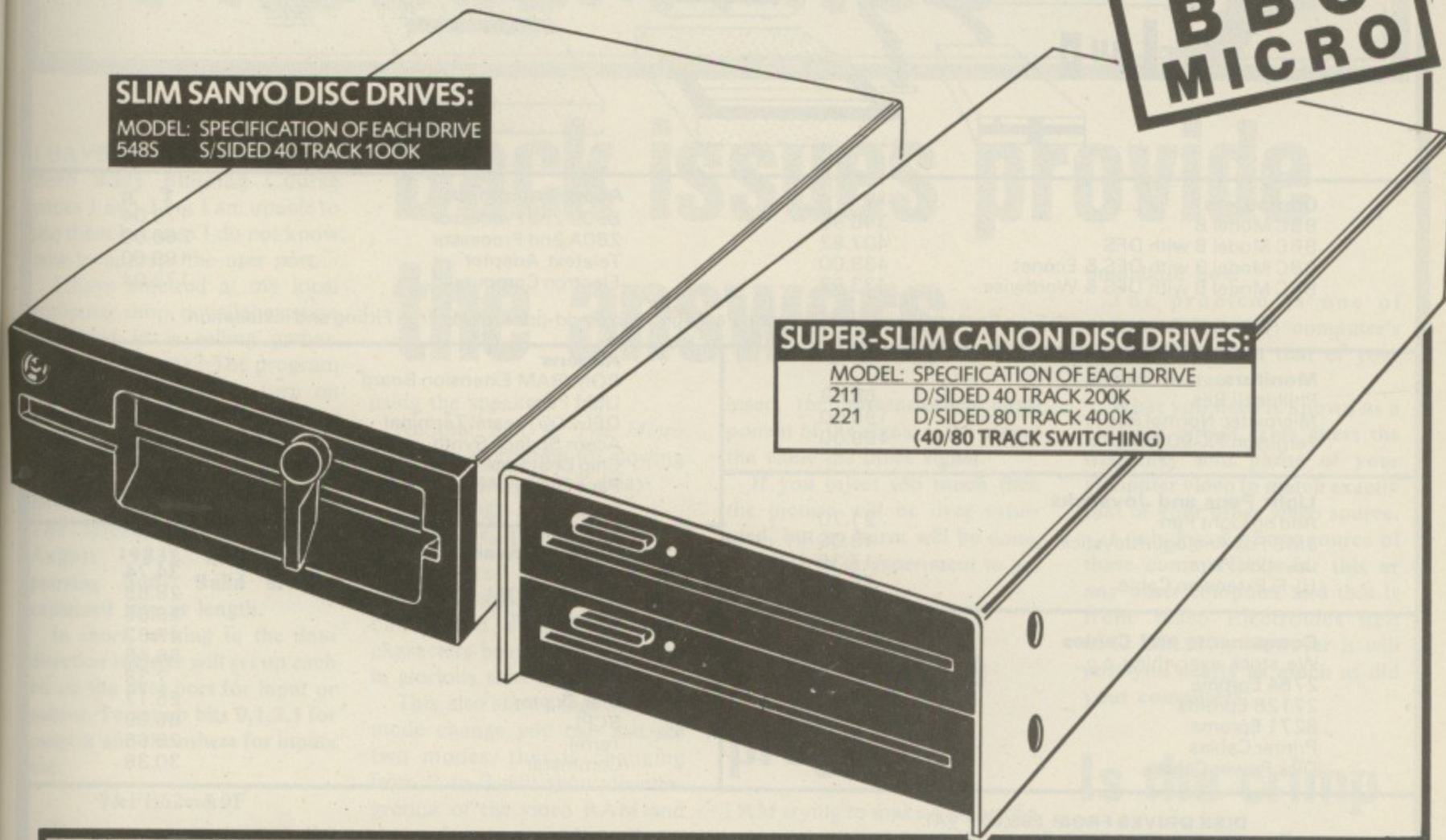

All inclusive price list:

This means: disc drive + case + all power & data cables + U.K. carriage + utilities disc & manual + V.A.T.

MODEL:	CANON					SANYO
	110	210	220	211	221	548S
Formatted Capacity per drive on BBC Micro:	100k	200k	400k	200k	400k	100k
Single Drive & Case:	£99	£139	£169	£179	£236	£154
Single Drive & Case/P. Supply:	£124	£164	£194	£209	£266	£184
Dual Drive & Case:	£204	£274	£314	£329	£437	£284
Dual Drive & Case/P. Supply:	£229	£299	£339	£359	£467	£314

Support:

Warranty: All disc drives sold by Chase Data Ltd. come with a full one-year warranty on parts & labour.

Non-warranty service: As THE experts in our field we can offer service on most makes of floppy disc drive.

Recalibration & Alignment ... £25 per unit inc. VAT. (parts extra). Phone for details: (Tel: 0784 38487)

Payment

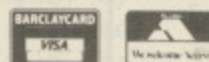

By Post: Send your remittance (cheques only please) with your order to:

CHASE DATA LTD

P.O. Box 6, Woking, Surrey, GU21 4PB.

By Phone:  (Tel: 0784 38487).

BBC Microcomputer in the NORTH

CTECH Computers Telephone: 061-366-8223/7794

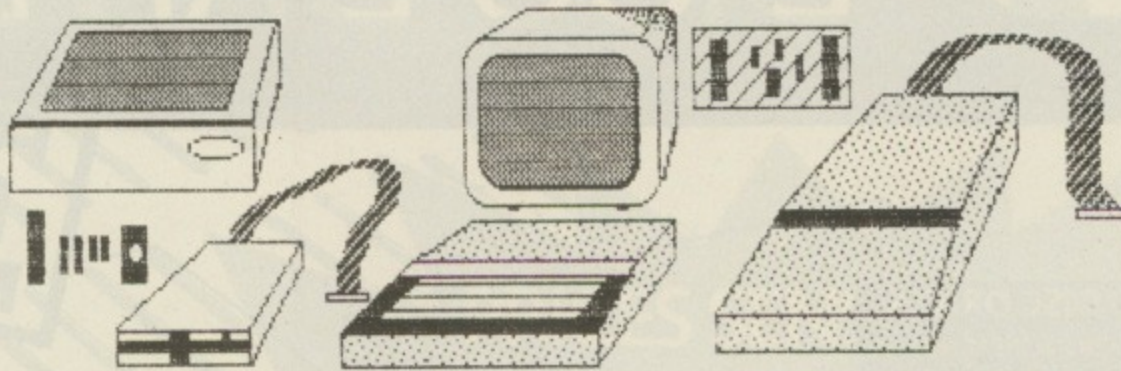

Computers	£ p
BBC Model B	346.95
BBC Model B with DFS	407.82
BBC Model B with DFS & Econet	439.00
BBC Model B with DFS & Wordwise	433.92

Acorn Equipment	£ p
6502 2nd Processor	173.04
Z80A 2nd Processor	260.00
Teletext Adaptor	199.00
Electron Computer	173.04

All computers come with Free Cassette Lead and Software Package. Most add-ons include Free Fitting and installation.

Monitors	£ p
Philips Hi Res	68.69
Microvitec Normal Res	199.00
Ferguson TX-90 RGB/TV	199.00

Addons	£ p
ROM/RAM Extension Board	40.43
Light Pen	21.69
OEL 200 Prestel Terminal	87.39
Acorn Speech Synth	47.83
Chip Chat Speech Synth	26.04
Pace Grapevine	POA
Disks	POA

Light Pens and Joysticks	£ p
Add on Light Pen	21.70
JMB Full Analogue Joystick	13.00
Joystick Pairs	17.35
Hi-Fi Extension Cable	£5.17

ROM Software	£ p
Wordwise	34.74
Graphics ROM	28.65
Print Master	28.65
View 2.1	47.83
Ultra-Calc	56.48
1.2 O.S.	7.38
Disk Doctor	25.17
BCPL	86.09
Termi	28.65
Commstar	30.39

Components and Cables	£ p
We stock everything e.g.:	
2764 Eproms	6.04
27128 Eproms	POA
8271 Eproms	POA
Printer Cables	12.99
Disk Power Cables	8.65

DISK DRIVES FROM £95.00 + VAT

Bare CHINON FO51D, Slimline, 40 Track, Single Sided. 100K (200K Double Density). As above but complete with Cables, Utility Disk, Cables, Case and Manual. **£109.00 + VAT**
 Bare TEAC55F, Slimline, 40/80 Track, Double Sided 400K (800K at Double Density). **£169.00 + VAT**
 As above but complete with Cables, Utility Disk, Cables, Case and Manual. **£199.00 + VAT**

DUAL DRIVES FROM £199 + VAT

Dual CHINON FO51D, Slimline, 40 Track, Single Sided 2 x 100K (2 x 200K Double Density). Complete with Cables, Utility Disk, Cables, Case and Manual. **£369 + VAT**
 Dual TEAC 55F, Slimline, 40/80 Track, Double Sided. 2 x 400K (2 x 800K with Double Density). Complete with Cables, Utility Disk, Cables, Case and Manual. (With your drive you may need an interface).

DISK INTERFACES FROM £69.00 + VAT

The Fabulous LVL Single and Double Density Interface. This will allow you to read and write to Acorn Disks see below. But also you can create your own Single OR Double Density Diskettes for extra online storage. Maximum capacity is 1.6 MB with 8 logical drives and 248 files. The standard Acorn Interface is available from us this uses the 8271 disk controller which gives very fast access to disk files. Acorn DFS is the standard for the BBC Micro it allows 31 files per disk and a maximum of 800K on 4 logical drives. **£85.00 + VAT**

PRINTERS

SHINWA CP80. 80 column, friction and tractor feed, Bi Directional logic seeking. Hi-RES and Block Graphics. Sub and Superscripts. Condensed, Emphasised, Underlining, Tabs and Italics plus more! **£199 + VAT**
 CANON PW 1080A. This is the latest state of the art in printer technology. This machine out performs the EPSON FX80. It will do everything the FX80 does and more besides and using the same control codes! What makes the PW1080A so special is not only it's superb value for money but the Near LETTER QUALITY mode. We include a free screen dump and our BBC Micro Instructions as well as the excellent manual. **£259 + VAT**
 QUEN 5100 Daisywheel. This British assembled printer has all the features that you would expect like Auto Bold, Auto Underline, Sheet Feeder option. Take Qume daisywheels and Ribbons. 20Cps Bi Directional. **£299 + VAT**
All prices Plus VAT

PRICES ...

All our prices are constantly moving, so please ring us to check the latest price.

FREE DELIVERY TODAY

(Orders over £90)

Ask about our installation service

If you are in Greater Manchester, Cheshire, Lancashire, Merseyside, Midlands, West Yorkshire or South Yorkshire, if you ring us now we can send one of our highly trained staff to install your computer equipment Today. (Now for Business software too!)

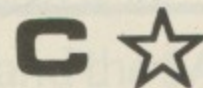

CTECH
COMPUTERS

**184 Market Street,
Hyde, Cheshire
SK14 1EX
061-366 7794
061-366 8223**

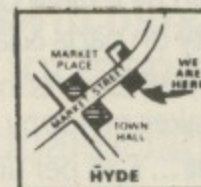

MIKE COOK'S PROBLEM PAGE

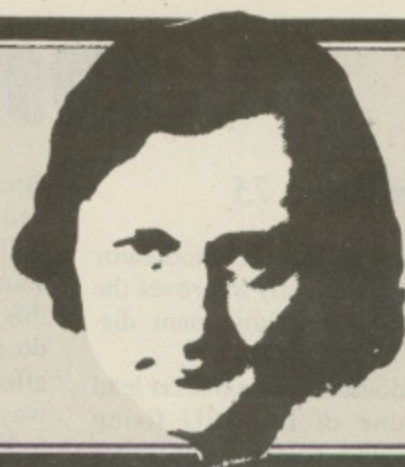

I HAVE recently purchased the Beeb Body Building Course packs 1 and 2 but I am unable to use them because I do not know how to address the user port.

I have inquired at my local computer shop, but all they seem interested in is selling games. Can you help me? The program I have to write is to turn on LEDs from a switch. — *Richard Mollett, Barkham, Berks.*

● It sounds as though you haven't got the back issues of *The Micro User* (July and August 1983). The accompanying Body Build articles explained this at length.

In short, writing to the data direction register will set up each bit on the user port for input or output. To set up bits 0,1,2,3 for outputs and the others for inputs use:

?&FE62=&0F

Then you can output to the port using:

?&FE60=A%

Or input using:

A%=?&FE60

The cost of colour

THE BBC Micro does not provide a colour output from the BNC connector.

However Acorn's reply was to connect a 470pF ceramic capacitor on the underside from the emitter of Q9 between IC45 and the UHF modulator — BC239 to the base of Q7 next to the empty IC97 — BC309.

After trying this, I found that although colour presence was noticed it was far too faint. Is there any way to increase the colour intensity?

I also discovered while examining the circuit diagram of the BBC Micro from the Advanced User Guide that it is also possible to take an audio output from PL16 instead of

Back issues provide the answers

using the speaker.

Another hint in *The Micro User* was a program for slowing down games — timed delay.

By typing:

?&FE45=1: ?&FE46=0

I discovered that the whole computer is slowed down. You can watch a mode change, characters being generated — all in glorious slow-motion.

This also shows that during a mode change you can just see two modes, that is changing from 2 to 7 will show disintegration of the video RAM and the appearance of Mode 7.

To revert to normal speed type:

?&FE45=11: ?&FE46=14

The value contained in these locations can be obtained by PRINT?&FE45, ?&FE46. — *Neeraj Sharma, Slough, Berks.*

● The trouble with this modification is the differing sensitivities of PAL decoders to the botched up colour signal that comes out of any computer.

To make this colour signal of a commercial TV standard would however double the cost of the computer.

To increase the intensity you could try increasing the size of this capacitor. So long as it is a disc ceramic type then you should have no trouble.

If you have another type why not put it in parallel with the first? This will effectively double the value. What it is doing is to

insert the chrominance component of the signal — the higher the value the more signal.

If you inject too much then the picture will be over saturated, but no harm will be done, so feel free to experiment to get the best results.

Videoing a program

I AM trying to make a video of a computer program. Unfortunately I cannot link the output of the computer to the video directly as the frequencies of the input/output of video and modulator are the same.

Is it possible to alter the frequency at which the modulator outputs the UHF signal? The way I am getting round that — by using a video camera on the TV screen — is not very satisfactory, but it was improved by using a switch on the camera which inverted the picture from positive to negative.

Of course there were different colours on the video as a result but the picture was much better.

— *S. Taurins, Abergavenny, Gwent.*

● It is not the frequency of the modulator that is at fault. This can be adjusted slightly by altering the slug accessed through the hole in the

modulator box.

The problem is one of synchronising the computer's video output with that of your picture source.

What you need is known as a Genlock circuit. This alters the frequency and phase of your computer video to match exactly that of your other video source.

I only know of one source of these commercially for this or any other computer and that is from Video Electronics (tel: 0942 882332). However it will cost you nearly as much as did your computer!

Is the crimp too thin?

I HAD problems last year with high resistance crimped connectors on three of the seven power supply leads — two of them within the power supply unit.

Since then I have tested nine PSUs, eight of them having potential faulty crimps, revealed by connecting a suitable resistor across each pair of supply wires in turn, to pass 2 amps.

Use a millivolt meter to measure the mV drop between OV on the PSU socket and the resistor end connected to the black wire.

A varying reading will indicate a fault at one of the two crimps at each end of the black wire. Similarly, connect the meter across the +5V socket of the PSU and the resistor end connected to the red wire.

In two cases the wire pulled out of the crimp. My opinion is that the wire is too thin for the size of the connector — which Acorn dispute.

I have also decoupled the

You've got a problem with your micro and you just can't sort it out on your own? Then write to MIKE COOK. If he can't help then probably no one can . .

—————▶

From Page 75

+5V supply to the modulator which significantly improves the quality of the subsequent display.

In addition I ran a thicker lead from one of the PSU fixing screws and soldered the other end to the modulator case. Lowering the source impedance to the area in question also marginally improves the display fed from the RGB output.

You will also find it revealing to measure the mV drop along each of the leads with the computer powered. — *D.P. Lawrence, Colchester.*

● Thanks for your advice. I have come across this problem on some of the very early series 2 printed circuit boards but had assumed that Acorn had got that one ironed out.

Boot up on power up

I HAVE looked at all my issues of *The Micro User* but I cannot find any reference to auto booting on power up.

I wish to use a BBC Micro for continuous monitoring of temperatures and require it to self boot should there be a power failure.

Can you help? — *Tim Fryer, Milton Keynes.*

● Your answer is on Page 93 of the January 1984 issue of *The Micro User*. Just make link 4 to change the auto boot option from Shift-Break to Break.

This will give a boot up on power up. (Note that diagram has holes labelled 1 to 8 and it should be 0 to 7.)

Speaking of damage . . .

I HAVE tried through Micronet, Prestel, experts and micro shops, but nobody will give me an answer to my question.

As I order *The Micro User* through my local newsagent, and as I consider it the best micro magazine on the market I thought who else but the expert himself to answer my query?

I own a BBC Model B. If I were to cut the internal wires,

disconnect the internal speaker and attach the wires to two small hi-fi speakers to get a better sound, could you please tell me if this would lose any memory or do any damage? And would it affect games programs in any way?

You are my very last hope for an answer. It really is important to me because the idea of having two speakers on either side of the computer with improved sound, speech synthesiser and games would be very impressive indeed. — *Robert Grant, Gatley, Cheshire.*

● Yes, you can do this. Wire the speakers in series and you should have no trouble.

Simple cut is OK

I HAVE just installed a disc upgrade on my Beeb using the directions in your article in the January 1984 *Micro User*.

My computer has an issue II motherboard so I was expecting

IF you have a technical query for this page, send it to Mike Cook, *The Micro User*, Europa House, 68 Chester Road, Hazel Grove, Stockport SK7 5NY.

Letters on other subjects should be sent, as usual, to Micromail, which this month starts on Page 177.

to have to cut pin 9 on IC 27 etc, but I found that the IC was not soldered in. So I decided to remove it from the socket and bend up the pin.

Then I noticed that the track from S9 didn't seem to go anywhere under the socket, although on the reverse of the PCB pin 9 was joined to pin 7 by a wire.

I have simply cut out the wire and not tried to bend up the pin or cut the track. Do you think this will be OK? And can you tell me what the symptoms would be if not? — *J. Clifford, Bracknell, Berks.*

● Yes, this should be OK. The symptom of it not being OK is failure of the discs to work at all.

Teletext . . . or Prestel?

PLEASE could you help me with two questions?

1. I have a teletext adapter with ROM. Is it possible to run an assembly program enabling the

ROM to work with a modem, and if so how?

2. I have a View ROM fitted. As I have an Acorn GP100A printer is it possible to convert the printer pad for the Epson printer to allow me to get out of the printer what the manual says, or can you possibly publish a program?

I would be most grateful as I cannot afford to buy an Epson printer. — *R.B. Dingle, Hounslow, Middlesex.*

● I think you are confusing teletext with Prestel. They are totally different systems having a common display format.

So the question of running the adapter with a modem does not enter into it. Unless of course you want to send teletext pages to someone else down the phone line.

View requires a printer driver to get all the effects available on a specific printer. These will slowly become available along with a do it yourself customising printer driver.

In the meantime if anyone has written one we would be glad to publish it.

Cool it — with an owl!

AS I experience overheating problems with my BBC Micro — no doubt due to the sideways ROM board — it would appear sensible to improve the micro's ventilation.

Fans or other electro mechanical devices are, in my opinion, undesirable because of their noise.

However, suitably drilled holes in the casing should ease the problem. There appears to be sufficient gaps for the air intake around the tube and 1MHz bus plugs, but the airflow appears to be restricted by the upper casing.

If the upper casing or lid was drilled with sufficient holes the airflow would be improved.

One idea is to drill holes in the form of the owl to maintain the aesthetics of the micro, in the north west corner of the lid.

Before taking this irreversible step I would like your advice on the validity of the theory.

One other idea I would sincerely like to employ is to install a switchable dummy load

in the loudspeaker circuit.

This will enable my children to play their noisy games in the living room without irritating the rest of the family.

The circuit is simple enough:

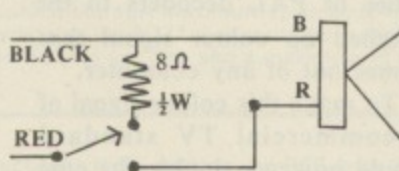

A most suitable position would be underneath the micro in the recess beneath the keyboard and alongside the name "BOOTHROYD". This would prevent the switch being accidentally knocked and gives plenty of room inside the micro for installation. Connectors should be used to enable the keyboard to be removed.

Lastly thank you for the best micro magazine on the market, it never comes out soon enough for me! — *A.P. Randall, Weymouth, Dorset.*

● Yes, drilling holes in the lid will help to solve your problem of overheating. I think it's a great idea to have the holes in the shape of an owl.

On the second point there is no need to include the 80hm resistor — just switch out the loudspeaker. This was one of the first modifications I did on my own computer.

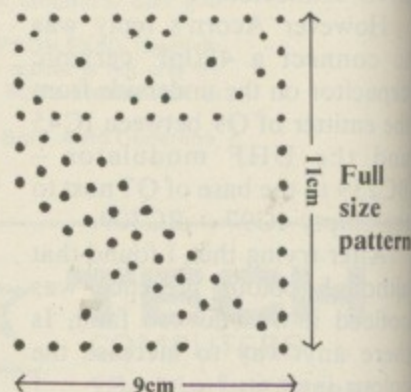

Underside of casing should have a thin loose weaved material or mesh glued to it, to prevent small objects dropping through the holes.

We're on the MOVE

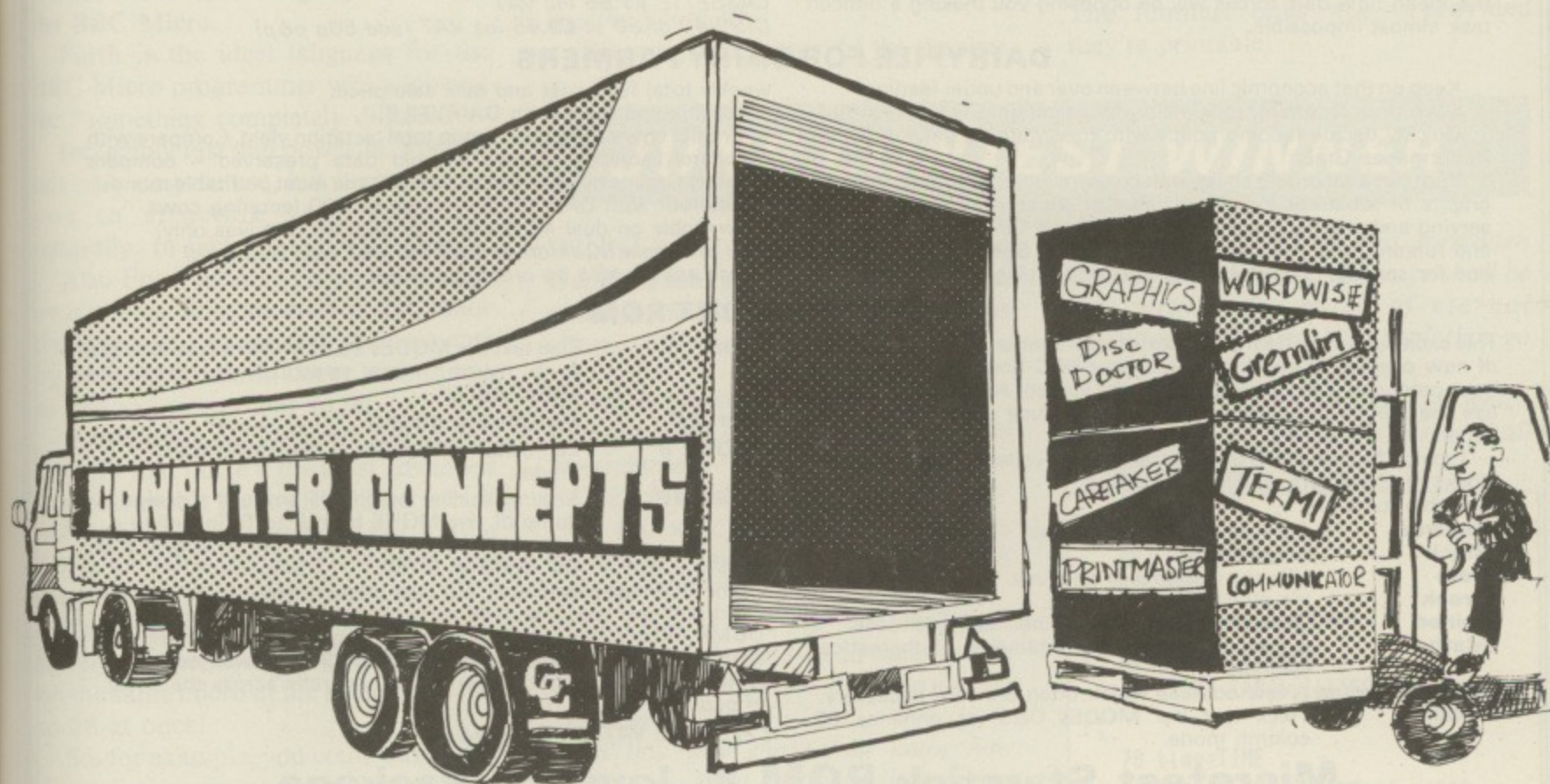

To Gaddesden Place, Hemel Hempstead, Herts HP2 6EX
Telephone: (0442) 63933
On the 1st August 1984

**Computer Concepts are expanding and require machine code programmers
with experience of Z80/6502 processors.
For further details of vacancies write to:**

**The Manager
Computer Concepts
Gaddesden Place
Hemel Hempstead
HERTS HP2 6EX**



SATAN'S CHALLENGE

or (Nevil Rides Out) A Black Magic Adventure



Dare you take up the challenge laid down by the most evil and sinister of all beings . . . the devil himself.

If you do you will find yourself alone and at the mercy of the twisted fancies and whims of a cold and calculating mind.

Occult forces are threatening the lives of those near and dear to you. Their only salvation rests in your hands but in accepting the challenge your own existence is put in severe peril.

In taking up the challenge you have to find the TALISMAN and locate a pentagram which then has to be prepared for the final rite. In the mean time dark forces will be opposing you making a difficult task almost impossible.

Do not allow yourself to be lulled into a sense of security for it will be short lived.

Many have gone before only to swell the ranks of the damned.

This is the latest adventure from the stables of Microtest and has been written with the acclaimed features of other adventures in mind eg save facility, quick response, simple but extensive commands, a mixture of logical and fiendish problems to solve.

Be warned this is an easy adventure to get into but devilishly difficult to end.

CASSETTE £7.95 inc VAT

DISC 40 or 80 tk £9.45 inc VAT (add 50p p&p)

DAIRYFILE FOR DAIRY FARMERS

Keep on that economic line between over and under feeding!
Save time recording milk yield and calculating feed amounts!
Quickly decide feeding policy with the 'Monthly Calving Group' Performance Graph!

Print out a recording sheet with cows in numerical order. Print out graphs or tables of individual cows or Monthly Groups showing serving and pregnancy details, illness record, Calving Index, weekly and running total Margin over Concentrate. See at a glance cows due for serving, pregnancy diagnosis and drying off. Keep track of

weekly total feed cost and milk sale price.

All this and more with DAIRYFILE.

Predict cow or Monthly Group total lactation yield. Compare with Standard Lactation Curves. All old data preserved - compare Monthly Groups over the years. Which is the most profitable month?

Find out with DAIRYFILE - for up to 200 lactating cows.

Available on dual 40 tk disc (For dual 40 tk drives only)

Dual or Single 80 tk drives £69 inc VAT (add 50p p&p)
Please state which on ordering.

MICROTEST FONT ROM

This exciting new ROM from Microtest will enable you to get all sorts of new characters and fonts from your BBC Computer. Once you have produced your masterpiece on the screen, all you have to do is use the inbuilt screen-dump utility to produce a hard copy onto paper.

Typing '*HELP FONTS' gives a list of available fonts and the blocks of characters which they replace.

Available fonts are:

- *Accents Accents and miscellaneous.
- *Block Small capitals.
- *Data Like the bottoms of cheques.
- *Greek It's all Greek to me too!
- *Joined Standard capitals with joined up lower case.
- *Maths A mix of until now unobtainable Mathematical symbols.
- *Miscellaneous A few oddities which often are very necessary.
- *Thick Thick text (for MODEs 0&3) to enhance 80 column mode.

*Thin

Thin text (for MODEs 2&5) which makes modes 2 & 5 much more readable or perhaps "READABLE".

*Vertical

For labelling graphs.

*MODE 8

Ten column multicolour, memory-miserly mode.

*S DUMP

A dump facility which will produce a screen dump of any MODE from 0 to 8 (including a text only dump in MODE 7) on an Epson, Star, CTI CP80 or MT80.

The ROM uses absolutely NO user memory and can be used with word processors etc. as well as normal BASIC programs. The DUMP utility will produce positive or negative graphics and will also rotate the picture produced through 90° as well as being able to position the picture anywhere laterally across the sheet of paper.

£17.50 inc VAT (add 50p p&p)

Microtest Starstick ROM & Joystick Package

Now available the Starstick ROM and Joystick. This comes in three forms:

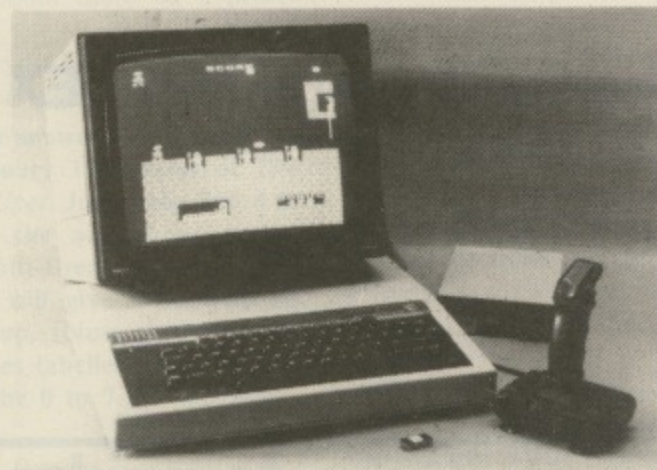

Enables you to use our joysticks on most programs even those that do not offer joystick capability.



available from

MICROTEST LTD

18 Normandy Way, Bodmin, Cornwall PL31 1EX

Telephone: 0208 3812

OR ANY GOOD DEALER

Large picture shows BBC Computer System and a Quickshot II Joystick. Small inset just a few of the joysticks that will work with the patch lead. Screenshot by kind permission of SUPERIOR SOFTWARE

All MICROTEST ROMs are fully TUBE® compatible. (TUBE® is a reg. trademark of Acorn Computers).

VISA



Go
M

THIS mo
Skywave
ROMs -
the BBC

Forth
BBC Mi
for "son

Incred
not only
you to
naturally

Also
own wo
the lang
by creat
as plott

In a
features
Forth a
only is i
Forth-8
support

This
pletely
on the
to 28 a

So, f
micro
workin
receivi
while

Dear B

Go Forth and Multitask!



ANOTHER GREAT FREE COMPETITION

THIS month we're giving away three of Skywave Software's Multi-Forth 83 ROMs – the latest language ROM for the BBC Micro.

Forth is the ideal language for the BBC Micro programmer who's looking for "something completely different".

Incredibly fast and powerful, Forth is not only easy to use, but it also guides you to structure your programs naturally. In fact you have no choice.

Also Forth allows you to define your own words. This means you can tailor the language to your own requirements by creating words to cover such things as plotting circles and so on.

In addition Multi-Forth has many features that make it the most advanced Forth available for the BBC Micro. Not only is it the latest version of Forth – the Forth-83 FIG standard – but it also supports multi-tasking.

This means you have several completely independent programs running on the same micro at the same time – up to 28 at once!

So, for example, you could have your micro listing one program while you're working on another – or you could be receiving messages via your modem while still using your word processor

program.

As you can see, the potential is enormous, so why don't you try to win one for yourself?

The competition must be the simplest

ever. You must have read Bob's letters to Trev in Micromail – all you have to do is to send us Trev's postcard to Bob. The funniest ones win – provided they're printable!

JUNE CONTEST WINNER

WINNER of our June contest was Geoff Eisenhauer of Ipswich, who receives a 6502 second processor for his efforts. The winning entry was:

IN the beginning there was REPEAT. And the Lord Acorn said unto the first programmer: "As oft as ye shall use REPEAT so shall ye use UNTIL.

In this way ye shall go through any section of program as oft as ye shall choose.

On the first pass thy "counter" shall be known as one and on all other passes shall thy counter be known as "counter+1".

In this way shalt thou know how many times thou hast been through thy process.

But beware of the forbidden GOTO within thy REPEAT... UNTIL loops.

For, if ye shall eat of this forbidden command in thy loop, verily, ye shall be lost within the maze of eternal repetition. And on thy belly shalt thou go for the rest of thy PROCs.

And the fruit of the knowledge which cometh from the second processor shall be denied thee".

```
10 REPEAT
20 counter=0
30 REPEAT
40 counter=counter+1
50 COLOUR counter
60 PRINT TAB(6,16)"COLOUR ";counte
r;" "
70 time=TIME
80 REPEAT UNTIL TIME=time+100
90 UNTIL counter=15
100 UNTIL FALSE
```

POST CARD

Dear Bob

Name _____

Address _____

Trev

Enter Trev's message to Bob on the left of the postcard (no more than 200 words), fill in your name and address in the space provided on the right, then send this coupon to: Forth Contest, Micro User, 68 Chester Road, Hazel Grove, Stockport SK7 5NY.

Hey Prestel. A new dimension for the BBC Micro.

Add the new Prestel Adaptor to a BBC Micro and you can download all programs available on the Prestel service.

Which considering Prestel is fast becoming a major software source, is a very attractive proposition indeed.

You can, for example, connect it to the growing Micronet 800 database. This



gives you an extensive choice of educational and business programs. Other 'closed areas' for private company communications are also available.

And that's in addition to games that range from simple to sophisticated. Plus electronic shopping and banking facilities, and an extremely useful personal 'mailbox' service.

But that's only the beginning. The Adaptor

also enables you to access Prestel information on any TV or monitor. And store the data so that it can be displayed or manipulated how and when you require it.

What's more, the Prestel Adaptor turns your BBC Micro into a terminal that can link with other dial-up computers with 1200/75 baud interface.

So you can, for example, have access to the British Telecom Gold electronic mail and telex service.

In fact, the enormous potential of our Prestel Adaptor, coupled with a surprisingly modest

price of £99 + VAT, make it a most exciting not to mention economical way to get more from your Micro.

The BBC Prestel Adaptor is currently only available via mail order.

You can order it on your credit card by ringing 01-200 0200 at any time, or 0933-79300 during office hours.

Alternatively, send off the coupon below.



Technical Specifications

For use with any BBC Micro 'B' with 1.2 MOS or later issue.

Prestel Language ROM supplied.

Dealer will install ROM together with MOS update if required in the BBC Micro.

Interfaces to any BT connection attached to 1200/75 baud dial up system (eg. Prestel, Micronet, Telecom Gold).

A BT socket outlet of the latest type will be required.

Connection via RS423 serial port.

Height 70mm. Width 210mm. Depth 350mm.

Colour: BBC Computer Cream.

Power in 240v, 50HZ, 15w.

Operating Temperature 10°-35°C.

To: BBC Microcomputers, c/o Vector Marketing, Denington Estate, Wellingborough, Northants NN8 2RL. Please send me _____ BBC Prestel Adaptor at £113.85 each, inc. VAT and delivery. I enclose PO/cheque payable to Readers A/C, Acorn Computers Ltd, or charge my credit card.

Card Number _____

Amex/Diners/Visa/Access (Delete)

Name _____

Address _____

Postcode _____

Signature _____

Registered No. 140 3810 VAT No. 215 400220

BU9

The BBC Microcomputer System.

Designed, produced and distributed by Acorn Computers Limited.

ONE of the favourite settings for an adventure is a deserted spaceship. I can only think of one book which begins in similar fashion – namely “Tiger Tiger” by Alfred Bester.

It's an interesting story because not only does the hero have to escape from the wrecked and empty spaceship but he also has to rediscover his ability to jaunt – that is, to travel through space by thought alone.

To achieve this he has to locate a number of objects and people, whom he interrogates telepathically, travel through a maze called the Gouffre Martel, open a safe and eventually distribute around the world an incredibly powerful substance which caused the original Big Bang and can be exploded by anyone just thinking about it.

The moral that we are all responsible for, and in the front line of, a nuclear war was made quite clear.

Unfortunately adventures are nowhere near this thought-provoking level, partly because the complexity is beyond the modern micro and programmer and partly because originality is rarely profitable.

Consequently space adventures almost always feature a cryptic computer, lifts that don't work, doors that won't open, engines and generators to be mended and shuttles to be flown, plus the occasional space suit to locate.

Robots are almost constantly on the prowl and the dilithium crystals can only be mined at the end of an underground maze – tough luck if you forgot the spade or the gadget to fix the drill.

The Five Spheres of Goliath by Kansas is the fifth deserted spaceship I have encountered. The main difference is that this one has sound – you get Melvyn Bragg's theme tune by Paganini as your predicament unscrolls.

The first problem is to escape from your cell. This is *quite* a problem because, although you know the ship is at rest – Einstein steps back in amazement – I had to search the cell before I could find the bed and mattress I had just been sleeping on and then I couldn't climb on it or go up.

The next problem was to repair the generator accompanied by a nice sound effect that fades as you move away.

I stood there admiring my

Alice through the VDU

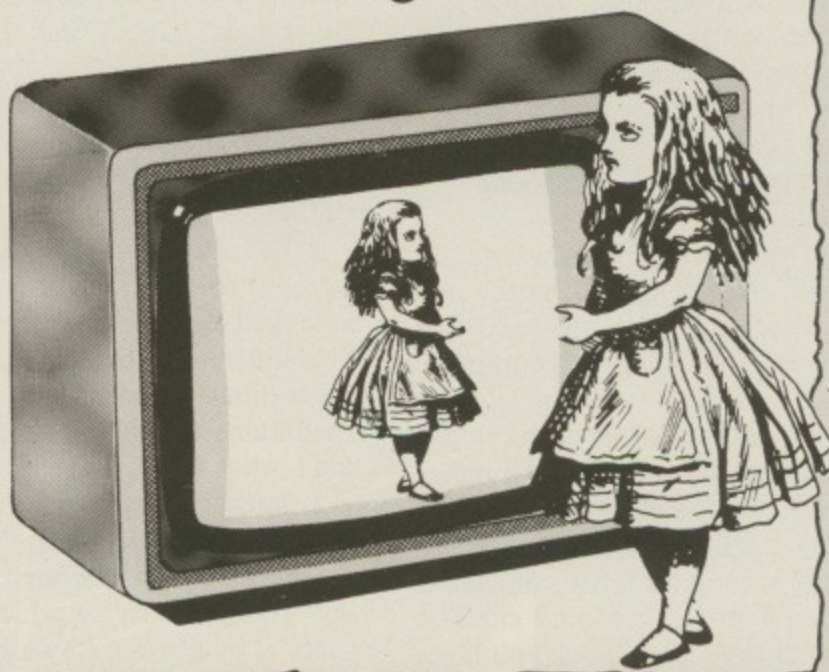

Our monthly foray into Adventure games

Space venture to the music of the spheres

handiwork. It would have been a neat trap to have the sound deafen me had I stayed too long, but, as usual, I knew I was safe because I had taken the hint that “There are more things in heaven and earth, Horatio” and (look it up) “if we list”, followed by GOTO 140, the program can be read and restarted. Actually I needed this because the SAVE wouldn't work.

Apart from the generator I found the lift and car sound effects a bit tiresome. I hate waiting, and there is a deal of going to and fro to get the coins to get the balls to get the wire to open the safe, and so on.

You have 500 moves to save the ship. I didn't manage it first time – the cryptic clue “Put the E between 1 and 3” baffled me.

Note that it does add more interest to have a move or time limit, and I eventually finished in 245 moves (PRINT T1%). I'm fairly sure that can't be beaten.

You can phone Kansas for help “when you get completely thwarted – and you will”. It surprises me that

people write in asking me to help when almost every manufacturer is delighted to answer questions – it gives them an idea of their market.

Incidentally, Level 9 now issues hint sheets which I can thoroughly recommend. They contain hundreds of clues cleverly mixed up and you can actually play the games in reverse – that is, reconstruct the game without buying the program!

In Startrek by Superior Software you are on the bridge of the starship Enterprise. North is the radio (Uhurules), south is the helm (Sulules) and west is the science computer (Spockless, but with button).

As usual everyone's left you and nothing is working, so go east into the lift which is dark and has a slippery floor. Some zealous midshipman has holystoned it into a death trap (until you get the lights on?). Make a note in the log to have him keelhailed.

You have a choice of five levels – Armoury, Transporter, Exobiology,

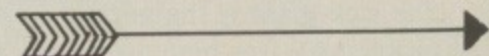

From Page 81

Engines (Scotty couldn't take it any more so he's gone, too) and Hanger, where there is a working shuttle.

Your mission is to get the dilithium crystals, new sensors and navigational computer and rescue Spock (surely they mean Kirk) from the Klingon ship just off the port bow. He's in room 84 - the Klingon brig.

To help you further the crystals are in room 63, the sensors go on the hull of the Enterprise - room 89 - and you have to steal the Klingon's computer from room 86.

There are two ways out of the ship - the transporter and the shuttle - one of which takes you to a flat plain (never seen a hilly one), which needs excavating, leading through a forest maze to a mountain which you can only climb if you have the right gear. Then you have to break into a maze of tunnels and off to work you go.

There are 101 rooms, the last of which does not contain the worst thing in the world. All in all a nicely thought out, logical game for Star Trek fans.

Having said something nice about a Superior Software game I'm afraid I must criticise their Lost City - it's by different authors and downright dull to play.

I have seen a good review of it that couldn't even get past the *first* problem - how to get out of the valley (WEAR BOOTS, CLIMB MOUNTAIN).

There are about 40 rooms - I worked that out from how the program scores - and it's quite tricky to see how you move between them.

Built into the room descriptions are the key words to get you to the next room.

You have to say OPERATE DRILL or you're stuck by a rockfall and EXCAVATE SPADE - what's wrong with USE and DIG?

Also the password appears to be randomly chosen from six words and the clue is the "cryptic words REMEMBER THE ICE" which is not cryptic.

So much for games I can solve but, even with MZAP, the machine code adventures make life difficult. Bob Redrup has been very helpful with Twin Kingdom Valley, having progressed to almost 900 points. He sent me a neat map laid out as described in my Hobbit article and "The Guide to Playing the Hobbit".

The sick giant is the answer to a lot of problems - free him, give him some-

thing, then move and wait. Most of the time he will follow you.

Lead him to Watersmeet, which cures both of you if you are weak. He can now help you to carry things but he is a bit greedy and tends to grab anything in sight.

With his help you can eventually enter the Large Hollow Chamber and reach the River of Gold and the Secret of Life.

I was stuck in the Wheel of Fortune so I wrote to Epic and got my legs smacked for being stupid. Surely I "should realise that a penny is worth more than an old boot", but I climb mountains in old boots and a penny ain't what it used to be.

I am currently rummaging at the bottom of the well (there's a ladder in the hut) but I'm not very intrigued by 250 rooms, most of which are "on a road", "by a well", "by a hut", etc, and the Mode 7 pictures aren't much help.

Nevertheless Epic has put a lot into this game and kids should enjoy it because it's random, freewheeling and illogical.

All my adventures are totally logical, so now for the solution to the Trap Door Maze in the May issue of *Micro User*. I called it that because it is not certain that you can return immediately to a room that you have just left.

Nevertheless the odds of never being able to return to Room 0 are about 1 in 10. This room does connect to all the others, so the game is solvable in practice.

Most people had no trouble with the first part - you GET all the objects and then leave a trail (AXE, BOTTLE, CORK, DAGGER, EGG, FEATHER, GUN, HELMET, ICON)

at each new (empty) room. You then GET JEWEL, tumble randomly back to Room 0, collect all the other objects and drop them in Room 0.

Everything disappears and the maze reconfigures, but now you can use SCORE (try it) to find your way to the money. Note that every time you TAKE the \$1,000,000 the maze will reconfigure and you are dumped back in Room 0. Nobody realised that you can use the money as a marker - just once.

Drop the money in Room 0 - which can always be reached by random moves and is now identified - and so for the long haul.

Imagine how easy the maze would be if you were ever told what exits were available as you enter a room. You have to work this out for yourself by careful choice and cautious move.

This steady, logical mapping requires clear thinking and patience to eventually get to the EXIT, take it, tumble back to Room 0, get the money and win.

Nobody worked out the final twist, but the nearest was S. Chmiel who, encouraged by our excellent prize, sent in a two-page explanation. If he can open the MOD2HEX safe he'll have to change his name.

This month's totally logical game has you in charge of the Filthy Fifteen - the toughest, most unsociable bunch of prisoners ever jailed. They can't stand each other for more than a night.

You have five cells and all you have to do is keep them happy for a week to win promotion. I'm looking for how you work out a solution rather than just an answer to this schoolgirl problem. Alice

```
10 REM THE FILTHY FIFTEEN
20 DIM P(15,15),N(15)
30 FOR I= 1 TO 15
40   N(I)=1
50   FOR J=1 TO 15
60     P(I,J)=0
70   NEXT J
80 NEXT I
90 FOR night= 1 TO 7
100  PRINT"night ";night
110  FOR cell = 1 TO 5
120    PRINT"cell ";cell
130    INPUT "The 3 prisoners are "
,X,Y,Z
140    IF X=Y OR X=Z OR Y=Z THEN PR
INT"DON'T CHEAT":GOTO 120
150    IF N(X)=night AND N(Y)=night
AND N(Z)= night THEN 170
160    PRINT"PRISONER ALREADY LOCKE
D UP":GOTO120
170    IF P(X,Y)+P(X,Z)+P(Y,Z)=0 TH
EN 190
180    PRINT"PRISONERS REFUSE TO SH
ARE A CELL AGAIN":GOTO120
190    N=night+1:N(X)=N:N(Y)=N:N(Z)
=N
200    P(X,Y)=1:P(X,Z)=1:P(Y,X)=1:P
(Z,X)=1:P(Z,Y)=1
210  NEXT cell
220  PRINT"DAY BREAKS AND NO RIOT S
O FAR"
230  NEXT night
240  PRINT"WELL DONE YOU ARE PROMOTE
D GOVERNOR":STOP
```

DOUBLE MEASURE...

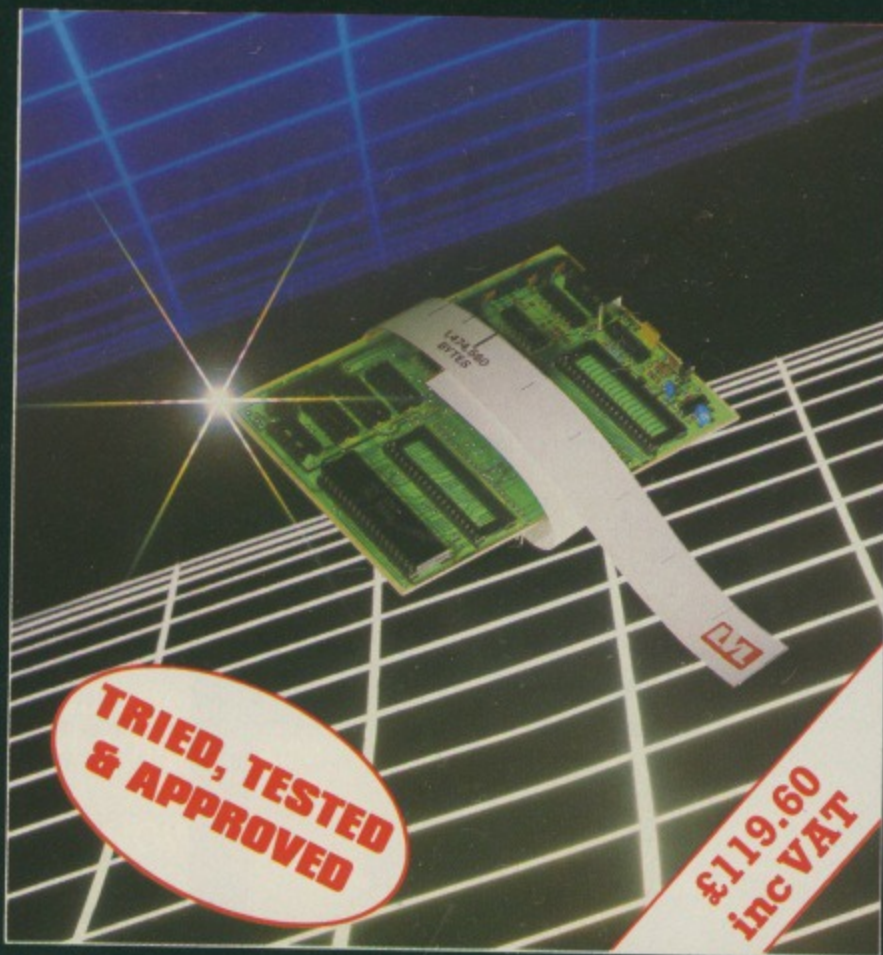

AVAILABLE FROM ALL LVL DEALERS. (FOR FURTHER INFORMATION TELEPHONE 0602 394000)

Twice as much storage capacity on your present or proposed discs.

The LVL *true double density* printed circuit board offers an amazing 1,474,560 Bytes of on-line storage, on a twin 80 track double density drive.

Removed is the 8271; (it is not capable of supporting double density). In its place, a small printed circuit board with a new disc controller and support circuitry provides a much improved data retrieval.

This drastically reduces read errors by using a phased locked loop data separator, which is superior to the standard window circuit.

Your BBC micro will now recognise the media density in the drive, and inform you if it is correct. You may define what density you require, 40 or 80 track, and which sides of the disc to use.

The device gives complete flexibility and comes with an Eprom containing firmware; manual, and a 40/80 track utilities disc. On a dual drive it is simplicity itself to copy existing software from single density to double density.

- Double Density
- Automatically checks for correct density
- No 8271 (Rare & expensive)
- Utilities provided
- Defaults to single density on power up
- 40 or 80 track
- Own PCB with separate 8Mhz clock
- Simple to fit
- User definable density
- Phase lock loop data separator circuit.



Scientific House,
Bridge Street, Sandiacre
Nottingham, NG10 5BA
Telephone (0602) 394000



OPTIMA SOFTWARE



The games that set the standard



SEA WOLF

So far all has gone well. You have successfully guided your submarine safely through enemy controlled waters and you are beginning to relax.

Suddenly alarm bells scream in your ears – you are under attack!

Desperately you scan the radar screen. Should you try to get him within range of your torpedoes, or attempt evasive tactics? Can you lead your crew to safety?

BED BUGS

The pests are after your feet and you'll have to move fast to stop them. Swot them with a jam sandwich or crunch them with your false teeth.

If you're desperate you can always phone for help. But whatever you do, do it quickly. You need cunning tactics and nimble fingers!

Bed Bugs guarantees hours of hilarity for the whole family.

OMEGA PROBE

Far out in the uncharted reaches of the universe lie the Omega zones from which no man has ever returned.

To explore this hazardous region the Earth's scientists have created the Omega Probe – the ultimate spacecraft.

As pilot of the probe, you face the unknown hazards of the Omega zones. Your mission: to survive.

This fast and furious machine code game with its tremendous graphics and many unique features takes arcade games to new heights of programming excellence.

Get these great games from your Acorn dealer or send off the coupon below to:

Optima Software Ltd, 36 St. Petersgate, Stockport SK1 1HL.

Sea Wolf

- BBC 'B' cassette £6.95
- Electron cassette £6.95
- BBC 40 track disc £8.95
- BBC 80 track disc £8.95

Bed Bugs

- BBC 'B' cassette £6.95
- Electron cassette £6.95
- BBC 40 track disc £8.95
- BBC 80 track disc £8.95

Omega Probe

- BBC 'B' cassette £6.95
- Electron cassette £6.95
- BBC 40 track disc £8.95
- BBC 80 track disc £8.95

I enclose cheque payable to Optima Software Ltd.

I wish to pay by *Access/Visa (*delete as appropriate).

Name _____ Card No. _____

Address _____ Expiry date _____

Signed _____

DRILLA KILLA

BUY BEFORE IT'S BANNED!

As you drill your way from a back alley to the Houses of Parliament, your victims include little old ladies, joggers, Hooray Henries and MP's of all persuasions. But watch out for the police!

This fast action arcade game features MODE 2 multi-colour graphics, superb sound effects, bonus scene/lives and a high score table.

Post the order form NOW.

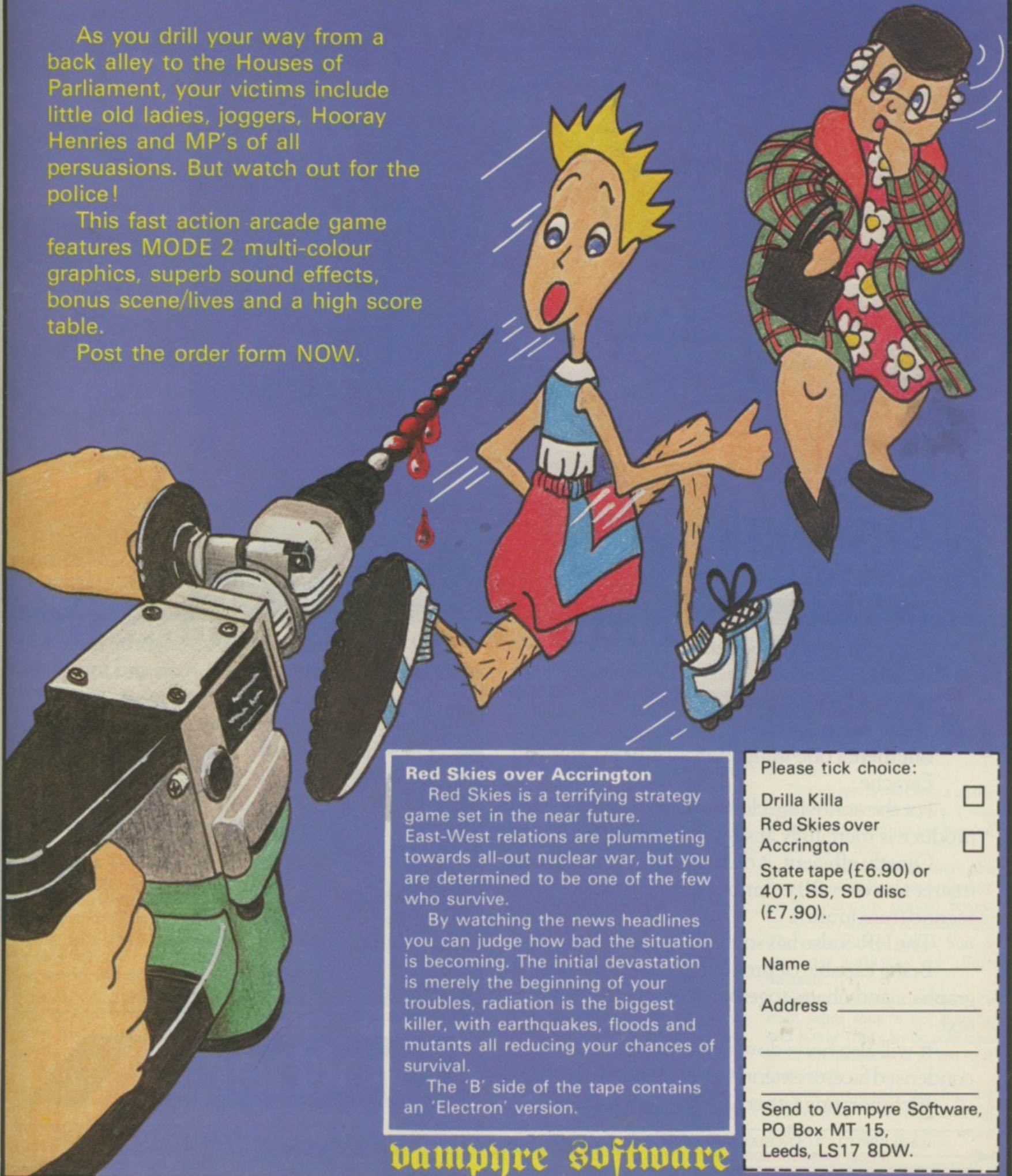

Red Skies over Accrington

Red Skies is a terrifying strategy game set in the near future. East-West relations are plummeting towards all-out nuclear war, but you are determined to be one of the few who survive.

By watching the news headlines you can judge how bad the situation is becoming. The initial devastation is merely the beginning of your troubles, radiation is the biggest killer, with earthquakes, floods and mutants all reducing your chances of survival.

The 'B' side of the tape contains an 'Electron' version.

Please tick choice:

Drilla Killa

Red Skies over Accrington

State tape (£6.90) or 40T, SS, SD disc (£7.90). _____

Name _____

Address _____

Send to Vampyre Software, PO Box MT 15, Leeds, LS17 8DW.

vampyre software

Little Brothers should be seen but not heard.



**ONLY
£159.95
inc.VAT.**

A maxim which eloquently describes the Brother HR-5.

Less than a foot across, it's nonetheless loaded with features.

But there's one thing the HR-5 won't give you. Earache.

For the annoying 'clickety clack' many printers produce is mercifully absent from the HR-5.

Quietly efficient, it delivers high definition dot matrix text over 80 columns at 30 characters per second (maximum).

The HR-5 also has something of an artistic bent.

Being capable of producing uni-directional graphics and charts together with bi-directional text.

It will also hone down characters into a condensed face, or extend them for added emphasis.

Incorporating either a Centronics parallel

or RS-232C interface, the HR-5 is compatible with BBC, Spectrum, Oric, Dragon, Atari and most other computers with these interface options.

Perfectly portable, the battery or mains operated HR-5 weighs less than 4lbs, and has a starting price of only £159.95.(inc.VAT).

Which is really something to shout about.

PLEASE SEND ME MORE DETAILS OF THE REMARKABLE BROTHER HR-5 PRINTER. BMU9/14

NAME _____

ADDRESS _____

TEL NO. _____



Life was quiet, until the mutant lobsters...

THE year is 2005, Earth has been devastated by a nuclear holocaust and the few remaining members of the human race have been forced back into an old way of life as cavemen.

Life was quiet until the mutant lobsters turned up.

In **Rubble Trouble**, you pit your wits and strength against ever increasing numbers of these flesh eating lobsters known as Krackats.

When the game begins you are in a maze of boulders which you can roll about to crush the crustaceans.

You may be thinking that this is just another Pengo type game, and you would be right. But there is one very clever variation.

Should you push a boulder towards a Krackat and miss it you had better be nimble, because these boulders bounce!

On many occasions an itchy trigger finger left me chewing rubble and watching another little caveman, complete with halo, floating upwards to that



great gravel pit in the sky.

One by one the rocks disintegrate. This, along with the increasing level of radiation, provides the game with a time limit, bonus points being awarded for a quick clearance.

The boulders come in three types. The first are common or garden rocks. The second blue in

colour, are worth 150 bonus points when crushed. Finally come the flashers, to be avoided at all costs as any attempt to roll or crush one results in a nuclear explosion.

Should you tire of this maze there are two further options. First there is the hayfield in which the maze paths are filled with illusionary boulders which can be walked through without the need to crush them, leaving a clear path behind.

By disguising the maze layout in such a way, rolling boulders and escaping Krackats can be a very risky business.

Finally comes the invisible maze, where the rocks are invisible except when rolling. Not for the novice.

Excellent graphics and good use of sound combined with a well implemented twist of an established theme kept me at the computer until 2am.

Micro Power has got yet another winner.

Jon Revis

MRM
SOFTWARE

CASTLE ASSAULT

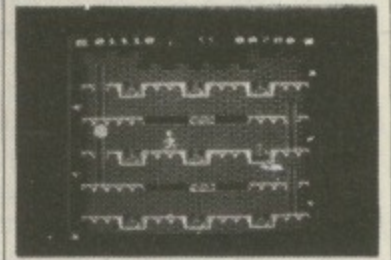

FOR THE BBC 32k (OS 1.2)

Low price - but still a challenge to the ace

CASTLE Assault is the first MRM game I have played, MRM being a fairly new name in software for the BBC Micro.

Anybody who has seen their advert for software at £5.70 must, like me, have thought the price was a reflection of the quality.

However as soon as the tape had loaded I was proved wrong.

The game description was well presented and the instructions equally simple. After tapping the spacebar I was playing.

The screen layout was a castle split vertically into layers. I was a figure standing on the bottom level of the five.

Three of the levels were the same, consisting of three smiling crabs sitting in sunken boxes, each crab jumping in succession. The other two levels had a moving walkway as their obstacle.

Firstly the crabs have to be leapt while they're not leaping and bonus fruit can be collected from the ladder end of the first four levels.

After eventually passing the crabs, you face the moving walkway which is even more

Rescue your loved one

SPOOKS and Spiders is an attractive and incredibly frustrating game.

You have to guide a silly little man through the haunted corridors of a prison to find and release "beautiful" damsels in distress who are being held prisoners behind one of the many cell doors.

To rescue his sweetheart, a key must be obtained to open the cell in which she patiently awaits her knight in shining armour.

This key is to be found hanging next to a door. To reach it a series of obstacles must be passed. For instance, giant spiders and irritating ghosts prowl the corridors acting as guards.

They can be avoided by a well aimed leap which is easier said than done. An accurate jump will clear them but experience is a must if you want to complete the first of the three stages.



If you are lucky enough - sorry, skilful enough - to gain possession of the key, great care must be taken not to bump into walls, ghosts or spiders for you will drop your key and use up

one of your three valuable lives.

A series of ladders takes you to different levels in the prison.

Once you have successfully opened all doors and rescued your loved one, you will jump for joy and pass onto the next phase - which seems more impossible than ever. The ghosts will become skulls and the whole game gradually turns you into a nervous wreck.

This is a difficult, but very enjoyable game which becomes compulsive since you always think that such a low score as your last can easily be beaten.

The skilful selection of colours and graphical displays used by Software Invasion make the game very presentable. My only criticism is that a wider range of sound could have been used to make it more entertaining and lively, although the sounds used are acceptable.

Mark Freeman

From Page 87

difficult. You have to jump on, run along, then jump off the platform as it oscillates from side to side.

I persevered, and eventually made it to the gold on the top level and so graduated to the next stage.

Stage two has the same basic layout - a change would have been nice - but the crabs are replaced by coiled snakes, boulders fall from the ramparts and a duck sometimes seen on stage one flies around, causing havoc if met on the same level.

In the unlikely event of reaching the gold again, a bonus man is awarded, the snakes turn into another leaping beast (there are six in all) and the usual increase in difficulty is encountered.

As you have probably guessed the game is a mixture of Hunchback and Killer Gorilla. The game runs at the same speed as Killer Gorilla, a little slow, and needs a high degree of accuracy in jumping like Hunchback.

The keys are the standard Z X

* ? with Return to jump. The sound is very arcade-like but unfortunately the man's steps lacked sound, as did the walkways.

However, the graphics are pleasant with well defined characters and clear movement.

The author has included the usual features including a high score table, a sound on/off during play and a pause facility. The status of the sound and pause is displayed on screen.

One annoying thing is that on hitting Break, in anger or by accident, the memory is cleared and the game has to be reloaded. I have noticed this on other games and I don't approve.

The game is of high quality, and represents excellent value for money. It's fun to play, if a little tricky at first, and needs a technique to be mastered for the crabs and walkways, more prayers for the ducks and boulders.

Personally, I would have preferred the game faster with easier jumps, but I strongly recommend it for the games ace looking for a challenge.

Andrew Smith

Good features, but it's too dear

KEY Definer and Character Generator from GSOFT allows you to load from tape or disc a set of function key definitions, and makes it easy to define the user defined characters.

Taking the second first, a 3.2k Basic program presents an 8 by 8 grid of red asterisks. You move around the grid by using the normal cursor movement keys.

Whenever you make a move the asterisk in the new position turns white, showing that the pixel concerned is now "on".

If you want to turn it off you must also press the spacebar.

I would have much preferred the opposite, more conventional method where the current pixel is not turned on unless a separate key is pressed, because in practice you will want more pixels off than on.

If at any time you press the Return key the shape you have designed so far appears on the screen and the eight numbers for the corresponding VDU 23 statement are given.

This allows you to easily

design the character, and save tedious calculation. (See pages 171 and 384 of the User Guide)

A good feature is that a definition can be saved to tape or disc and reloaded into the Basic Micro's memory, although you want to include it in a Basic program you must naturally reproduce the VDU 23 statement manually.

All the instructions are on one screen and they are very compressed. The program is very easy to use and achieves its objective simply.

To use the function key definer, simply type *LOMUCH KEYS. This can be done without affecting any programs already in memory.

Pressing key f0 will then allow you to use a printed document like a typewriter (mistakes on the screen deleted by the Delete key will be printed), f5 and f6 which give the current value of PAGE and TOP respectively and f9

QUICK RUNS

A first look at some of the latest releases

Spitfire: A flight simulator. Test your skill and concentration as you fly your fighter through a series of realistic and exciting manoeuvres, including take off, landing and looping the loop. Alligata.

★ ★ ★

Denis Through the Drinking Glass: In this zany text adventure you take on the role of Denis Thatcher whose aim is to avoid Maggie, overcome all the horrors of the political jungle, and reach the haven of the Gravediggers Arms. You'll meet them all on the way - the Royal Family, Ian Paisley, even the Pope. Every location is described in rhyme. Applications.

★ ★ ★

Blogger: As Roger the Dodger, master burglar, you work your way through several buildings searching for golden keys and emptying safes. As you rip off shops, houses and banks be on the alert

for many obstacles and spooky nightwatchmen. Alligata.

★ ★ ★

Neanderthal Man: In your endeavour to survive in a hostile land full of prehistoric animals, you must feed your family by returning to the cave and throwing food. Use your spear to kill predators as they menace you and your offspring. Alligata.

★ ★ ★

Contract Bridge: In this micro-simulation of the real game designed for one player, the computer bids the other three hands and plays your opponents' cards after the first trick. The program includes full instructions in conventional bidding and a running score sheet. Alligata.

★ ★ ★

Sea Adventure: You were sailing in the South Seas when your boat was holed

by killer whales. You are now adrift in this Mode 7 text and graphic adventure and trying to return safely to England. All movement is made using the function keys for single entry. Virgin.

★ ★ ★

Brainbox: In this two player strategy game you must attempt to wipe out your opponent's brain using a laser beam. You direct the beam at him by positioning deflecting prisms according to certain preset rules. Randomly placed prisms interfere with your plans. Virgin.

★ ★ ★

Web Runner: Try your skill and reactions as you attempt to escape from an enormous spider's web after planting a bomb in each corner. You will be chased continuously by a motley bunch of flies, spiders and centipedes which you can only eliminate with your laser. Alligata.

t it's
lear

cter, and save
on. (See page
e User Guide
re is that th
saved to tape
d into the BB
y, although
de it in a Bas
must naturall
DU 23 state

ions are on th
are very clear
ery easy to us
objective.
function ke
type *LOAD
can be don
any program
ry.
ey f0 will
use a printer
er (mistakes
by the Delete
, f5 and f6 will
ue of PAGE
ely and f9 will



give the Ascii value of any key pressed.
The rest of the keys will do simple things such as CHAIN or SAVE a program. There is not much value in this part of the package, and it is rather a stocking filler.

Both programs transfer to disc easily and the brief documentation is adequate.

However there are other character definers available which are comparable and much cheaper than £9.95.

Norman Kirkby

Realism is the key!

STOCK Car is yet another new title from the prolific Micro Power software house.

In this game you take on the role of a stock car ace pitting your wits against three computer controlled cars – two in the two player game – as you power your highly tuned machine around a choice of six circuits.

The aim is to achieve the fastest average lap time for any of the circuits, the current records being displayed in the high score table.

Once loaded, the game can be set up to your own requirements by setting the number of players, choice of circuit, number of laps, and finally the degree of skid required.

This last factor is the one which provides the game with its realism. I found that when using a skid factor of 20 per cent the car was a dream to drive – the skid factor is not necessarily a disadvantage. By beginning to turn just before entering a corner the car can be drifted rally style



around the bend.

Great fun can be had by blasting down the outside of the straight in top gear and then cutting across and taking the inside line through the bend, passing some computer controlled dummy who has left you the smallest of gaps. Yet another

computer car "bytes" the dust.

Once you think that you've mastered the game, try it with the oil slicks. These appear randomly around the circuit. Once every car has passed them the slicks vanish and reappear somewhere else. Quite often somewhere else just happens to be directly in front of your car.

To say handling is impaired when passing through a slick is a bit of an understatement, you would have more control driving on ice.

Taking a peek at the computer's cars, while grappling with the controls in the middle of an oil slick, I noticed that they appeared to pass through the oil without a waver. I can only assume that they were fitted with tyres of a different rubber compound to mine.

My first impression of the game had been one of disappointment with the graphics – the user's car being the only

ow adrift in
ic adventure
to England.
the function
n.

ver strategy
ipe out your
laser beam.
at him by
s according
omly placed
ans. Virgin.

skill and
escape from
ter planting
You will be
otley bunch
edes which
with your

Frak: Move Trogg the cave man around by climbing ladders and jumping rocky ledges as you search for golden keys to progress to the next level. Avoid at all costs the flying knives and floating balloons. Various nasties you will meet can be thwarted with your Yo-Yo! Superb graphics. Aardvark.

★ ★ ★

Caesar the Cat: Using keyboard or joystick you try to get Caesar to clear the larder of mice by catching them and taking them through the door. As they eat through the larder's contents and flit about on the shelves you must avoid knocking down crockery. Mirrorsoft.

★ ★ ★

Football Manager: Take on the role of a football manager as you strive to achieve promotion from Div 4. Using an on screen menu you can swap between

buying and selling players, selecting your team, viewing the fixture list or league table, and playing the game. You can even watch graphic edited highlights as the teams battle it out. Addictive.

★ ★ ★

Manage: In this interactive management game for two players you make decisions that will influence your opponent's market. Users will learn the significance of pricing policy and the correct allocation of cash resources. CCS.

★ ★ ★

Mystery of the Java Star: Four part adventure with each part loading separately. You can only progress to the next part when you are successful in the previous one. The object is to search for a shipwreck and in it find a ruby called the Java Star. The game climaxes in a

real time search of the sea bed with restricted air. Shards.

★ ★ ★

Frac Attack: An educational package of six games based on the understanding of fractions. Options include Shady Fractions (estimate the proportions of shaded squares), Frac Attack (shoot the wrong answers and rescue the right one), and Hungry Radish (find the biggest fraction or get eaten). Shards.

Arena 3000: It's the year 3000 and as a mere humanoid you take on waves of mutants in the entertainment arena. Moving around the screen under key control you fire your death ray in the direction of travel. The mutants only die after being hit several times, but you die from their slightest touch. As you clear each wave a different one arrives to take up the challenge. Microdeal.

From Page 89

multi-coloured character. But following an hour at the wheel, this no longer seemed of any significance. The beauty of this game lies in the realism of the action.

Jon Revis

One for the 'swarm' fans



SIMONSOFT Sprites Version Two came on a disc with 30 entries in the catalogue. This was certainly going to take some time to review! First step was to read the manual, 32 unnumbered pages.

It is immediately apparent that the author hasn't given too much consideration to disc users, as to use any program involves using the downloader provided and a table of PAGE values in the manual. Very messy.

However the two demonstration games included convinced me that if writing "swarm" type games is your bent then this one is for you.

Back to the package proper. The disc (or cassette) contains two sprite definition programs, 20 different sprite control programs (machine code for speed), two demonstration

games and some ready defined sprites assembled in "books" that the user can play around with.

The 20 programs give users access to almost any sprite effect they may want, and are packaged separately so that only the code needed for a specific effect is in the computer.

I was quite impressed by a number of features:

- The enlargement facility gives up to x5 magnification of a sprite. Both base sprites and their clones can be constrained to move along preset paths.
- Transfer plotting plus background storage. The background beneath a sprite is replaced after a sprite moves on. This means some loss of speed but sprites do not change colour when moving over background.

This is quite a nice package with a number of very good facilities for anyone wanting to write programs using lots of motion in Mode 2.

However the manual and/or the loading of the programs could be made a lot clearer for disc users.

Alan Plume

From je to elles

TENSE French by Sulis Software is an educational package for testing the user on 20 common French verbs, using any of eight grammatical tenses.

The first tape tests present, perfect, imperfect and future, while the second tests past perfect - better known as pluperfect - past historic, conditional and present subjunctive.

The program ran easily from cassette with good instructions. The Mode 5 display menu was clear, each option producing an instantaneous, well laid out display.

The options are: 1, Change of tense; 2, List of verbs; 3, Test on meanings; 4, Test on one verb; 5, Test on all/some verbs; 6, Change volume; 7, Leave the program.

For the test on meanings, there is the full list of 20 verbs on the left, while on the right of the screen in double height letters is: "What is the French for XX?"

The program offers the choice

'Pit' your wits against man-eating tomatoes

IMAGINE the scene - your keyboard slowly cooling down from white heat, your joystick wilting from the tension and your monitor reeling from the bombardment of electrons.

Suddenly you find yourself in a mine, and there's obviously no-one else down there.

You are given your objective - the quest for buried treasure. It is easy enough to get at, so where's the challenge?

Well, I've neglected to tell you about the ferocious tomatoes and the pot-bellied dragon, probably due to all the lighter fluid or equivalent required to breathe fire!

In *The Mine*, you have a side view of the shaft, and you control a particularly 'hunky' character who wanders around it, looking for buried treasure.

The program pits (no pun intended!) its wits against you in the form of giant man-eating tomatoes that rush after you.

The real enemies though are



the squat, pot-bellied aardvark look-alikes known as the fire breathing dragons. They run up to you and spew death all over you.

Your only defence against these menaces is the 'neutraliser' which, when activated near the menaces, starts to shrink them until they finally disappear.

However, a more dramatic way of killing is to cause the rocks to fall, smashing down on any menaces in hot pursuit.

This is the best version of the arcade game "Mr. Do" that I've seen, although the market isn't exactly flooded with them.

The quality of the animation and the detail of the graphics is quite superb, especially the mushrooms and the Aardvark clones.

The program includes a hall of fame for the top scores and offers the user a choice of using the keyboard or the joystick to control the character.

The cassette is, as is usual from this company, beautifully packaged with very comprehensive loading instructions including details for disc and Econet users.

The program is recorded twice on one side of the tape. I had no problems loading it.

All things considered, this is a program for small-time games dabblers and arcade addicts alike with many fascinating gimmicks and features.

Philip Tudor

MS

d home
y exam
hese into
n to

k
Core

gles
rels

and y in
nbers

.C. cricuits,
and parallel.

ss,

O.S.
bearings

symbols,
c charts

M.
DE L61 1AB.

*
ER GAMES
r games
line and
joystick

e £6.95
.95

derotes
ron
patible

ade fun.
positronic
out for its

.95

10 IBT.

ck or
cs.

NEW



GET A GRIP OF A&F SOFTWARE

*Commodore CM64
Chuckie Egg
BBC 32K Haunted Abbey*

AVAILABLE FROM ALL GOOD COMPUTER SHOPS

John Menzies



Selected Stores

	CM64	BBC	ELECTRON	DRAGON	SPECTRUM
CHUCKIE EGG	£7.90	£7.90	£7.90	£7.90	£6.90
CYLON ATTACK		£7.90	£7.90		
HAUNTED ABBEY		£6.90			
PHARAOH'S TOMB		£7.90	£7.90		

Sold subject to A&F Software Ltd.
Full terms and conditions available on request



Unit 8, Canalside Industrial Estate,
Woodbine Street East, Rochdale, Lancs
OL16 5LB. Tel: 0706 341111

P
t
v

VOR
dime
which
with
vorte
aliens
Yo
but
deple
quic
miss
If
you
throu
no h
you
face
inva
D
or be
but
scor
surv
you
T
get
ship
mov
but

Peril in the 3D Vortex

VORTEX is a Mode 4 three dimensional space game, in which your spacecraft is pulled with increasing speed into a vortex, dodging marauding aliens as you go.

You have the obligatory laser, but the enemy's return fire depletes your protective shields quickly – and they don't often miss!

If you can survive this section, you then weave your way through an asteroid storm with no help from your laser. Should you get through unscathed you face yet more and faster invaders and asteroids.

Death results from a collision or being shot with no shields left, but you do have five ships. Your score depends on how long you survive and how many aliens you shoot.

The 3D effect takes time to get used to, as does the way your ship arcs up the screen as you move left and right. The fire button is auto-repeat so saving



keyboard wear – a thoughtful feature.

The game is original, with clear, fast graphics – especially the moving background – complemented by exciting sounds. It is well presented and professionally written and is as good as, if not better than, previous Software Invasion releases.

The on-screen instructions are very clear and concise. The game supports joysticks in addition to keyboard control and there is a sound on/off option.

My only criticism is that all the stages are similar in screen format – they just get faster – and this tends to monotony.

Overall though, nice one. Software Invasion.

Andrew Smith

Only manual lets database down

BETA-BASE is a database program specifically for use with a disc system. Apart from the manual the package is well-designed and could prove very useful.

Many such programs rely on having entire datafiles in main memory when the program is running, restricting the maximum size of files.

This program, from Clares, makes use of the fast access capabilities of disc storage so that files can be held on disc with only a few records at a time in the computer's memory.

This enormously increases the quantity of data that can be handled and the only overall restriction is disc capacity. With about 10 fields per record and about 20 characters per field you could hold about 500 records on a 40 track disc.

The drawback of course, comes in the time taken up by accessing discs.

While it is possible to operate Beta-Base using only one drive, it does involve quite a few swops between the program and data discs. A dual drive system would be much more convenient.

The system offers searches on up to five fields and sorts on up to three. The searches can be

performed if wanted by looking for a search string within a field.

This facility is useful where you are uncertain how a piece of data may have been recorded or what it consists of.

The user can enter, view, amend and delete data. Calculations may also be performed on the fields to update them or to report their total.

The data – either all records or those specified by the result of a search – can be printed out in a specified order. The user can choose which fields are to be printed and there is flexibility of layout of the fields on the page.

The redefine option allows the user to add a new field or extend the length of an existing one.

Unfortunately the program is accompanied by an inadequate manual.

Referring, for example, to the transfer-option the manual says it is very powerful, giving the opportunity to transfer the whole or part of a file and to merge it with another file so that new databases can be constructed.

Exciting stuff, but this function was so badly explained that, despite several attempts, I couldn't get it to work.

Ken Garrett

The Micro User Index of software reviews

3 Deep Space (Postern)	Feb 1984	Dbasebeeb (Carrera)	June 1984	Hopper (Acornsoft)	Sep 1983	Physics (Program Power)	Dec 1983
3D Bomb Alley (Software Invasion)	Jan 1984	Delivery (Paeen Systems)	Apr 1984	Horror Castle (A & F Software)	May 1984	Physiological Simulation (Fiveways)	Dec 1983
Action of the Heart (Garland)	Sep 1983	Devil's Causeway (Kaydee)	Sep 1983	Hunchback (Superior Software)	May 1984	Pimania (Automata)	Mar 1984
Aid (Lincoln)	Jan 1984	DFS (Amcom)	Sep 1983	Hyperdrive (IJK)	Mar 1983	Printer Monitor (Watford)	Mar 1984
Alien Destroyers (Program Power)	Aug 1983	DFS (Watford)	Sep 1983	Inheritance (Simon Hessel)	Jun 1983	Programs I (BBC Soft)	Apr 1983
Alphabeta (H & H)	Mar 1983	DFS (Amcom)	Oct 1983	Invaders (IJK)	Mar 1983	Reading Music (Childsplay)	June 1984
Angle (Chalksoft)	June 1984	Disc Executor (Vision Software)	Jan 1984	Invaders (Software Invasion)	May 1983	Rocket Raid (Acornsoft)	Jul 1983
Animal/Vegetable/Mineral		Dragon Rider (Salamander)	Oct 1983	Jigsaw (ega beva)	May 1984	Screen Dump (DACC)	Mar 1984
(Bourne Educational)	Oct 1983	Easy Crasher (Salamander)	May 1984	Junior Maths Pack (Program Power)	Oct 1983	Sea Lord (Bug-Byte)	Apr 1984
Answer Back (Kosmos)	July 1984	ECFG (Gaelsett)	May 1983	Lemming Syndrome (Dynabyte)	June 1984	Shrinking Professor (A & F Software)	Apr 1984
Apollo (Software Invasion)	May 1983	Escape from Moonbase Alpha		Let's Count (Ask)	Jan 1984	Slick (BP Educational)	Jul 1983
Arcadians (Acornsoft)	Aug 1983	(Program Power)	Apr 1984	Lift off with numbers (Shiva)	Aug 1984	Snapper (Acornsoft)	Dec 1983
Atlantis (IJK)	Mar 1983	Escape from Orion (Hopesoft)	Nov 1983	Lines and Angles (4mat)	Aug 1984	Snooker (Acornsoft)	Oct 1983
Aviator (Acornsoft)	June 1984	Essential French Verbs (Carsondale)	Dec 1983	Love and Marriage		Snowball (Level 9)	Feb 1984
Beebcalc (Gemini)	Sep 1983	Eye (Longman)	Aug 1984	(Acornsoft/Ivanberg Software)	May 1984	Space Pirates (Bug Byte)	Mar 1983
Beebsynth (Clares)	Nov 1983	Facemaker (Ask)	Jan 1984	Lords of Time (Level 9)	May 1984	Sphinx Adventure (Acornsoft)	Jan 1984
Billiards (H & H)	Mar 1983	Firehawks (Postern)	Dec 1983	Lost in Space (Salamander)	July 1984	Spreadsheet (Micro)	Nov 1983
Bridge to the East (Ixon)	Mar 1984	Flints Gold (Micrograf)	Aug 1984	Man (Chalksoft)	June 1984	Sprite-Gen (DACC)	Dec 1983
Bun Fun (Squirrel)	Aug 1983	Forth (Level 9)	Nov 1983	Marklist (Optima Software)	Apr 1984	Spy (System)	Nov 1983
Business Games (Acornsoft)	Mar 1984	Fortress (Amcom)	June 1984	Mary Rose (Ginn)	Jan 1984	Star Maze II (Kaydee)	Oct 1983
Canyon (BBC Soft)	Oct 1983	Franklin's Tomb (Salamander)	May 1984	Missile Base (Acornsoft)	Apr 1984	Starship Command (Acornsoft)	Oct 1983
Cashbook (Gemini)	Aug 1983	Frogger (A & F Software)	Mar 1983	Music (BBC Software)	Apr 1983	Superfruit (Simonsoft)	Aug 1984
Castle of Riddles (Acornsoft)	Jan 1984	Fruity Freddy (Softspot)	July 1984	Music Editor (System)	Dec 1983	Supergolf (Squirrel)	Mar 1984
Chess (Bug Byte)	Apr 1983	Fungames (BBC Soft)	Apr 1983	Music Synthesiser (Bug Byte)	Jul 1983	Swoop (Program Power)	Sep 1983
Chess (Acornsoft)	Dec 1983	Fun to Learn (Shard's Software)	May 1984	Number Puzzler (Ask)	Jan 1984	Taxcalc (BBC Soft)	Nov 1983
Chess (Computer Concepts)	Dec 1983	Galactic Firebird (Kansas)	Nov 1983	Oblivion (Bug-Byte)	Apr 1984	Tess (H & H)	Apr 1983
Chickaroo (Screenplay)	May 1984	German Sentence Practice		Old Father Time (Bug Byte)	Jan 1984	The Grange (Dobsoft)	Jan 1984
Circus (Digital Fantasia)	Jan 1984	(Educated Owl)	Dec 1983	One Disc Home Office (Dr. Soft)	July 1984	The Synth (Musicsoft)	Aug 1984
Colossal Cave (Level 9)	Feb 1984	Ghouls (Program Power)	May 1984	Omega Probe (Optima Software)	May 1984	Timeman One (Bourne Educational)	Sep 1983
Commercial Accounts (Gemini)	Jun 1983	Grafkey (Clares Soft)	Apr 1983	Package 004 (Software Invasion)	Jun 1983	Toolbox (BBC Soft)	Mar 1984
Community (Ixon)	Mar 1984	Great Britain Ltd (Simon Hessel)	Jun 1983	Painter (A & F Software)	May 1983	Transistors Revenge (Softspot)	June 1984
Connect 4 (Database)	Apr 1983	Gunsmoke (Software Invasion)	Nov 1983	Pascal, Sequences, Puncman		Vampire Castle (Micrograf)	Aug 1984
Cosmic Kidnap (Superior Software)	June 1984	Heist (Softspot)	Aug 1984	(Chalksoft)	Nov 1983	Vu-File (Psion)	Nov 1983
Countdown to Doom (Acornsoft)	Jun 1983	Hide & Seek (Ask)	Jan 1984	Peeko-Computer (Acornsoft)	Feb 1984	White Knight (BBC Soft)	Dec 1983
County (SM) (Bryants)	Mar 1984	Hobbit (Melbourne House)	June 1984	Pengo (H Soft)	Feb 1984	Wordhang (Bourne Educational)	Oct 1983
Cylon Attack (A & F Software)	Feb 1984	Home/Business Pack (Gemini)	June 1984	Philosopher's Quest (Acornsoft)	Jan 1984	Wordwise (Computer Concepts)	Jul 1983
Datext (Optima)	Jan 1984	Home Finance (BBC Soft)	May 1983			Zany Kong (Solar Soft)	Sep 1983

TRACKER DUAL DRIVES

AT SINGULAR
PRICES

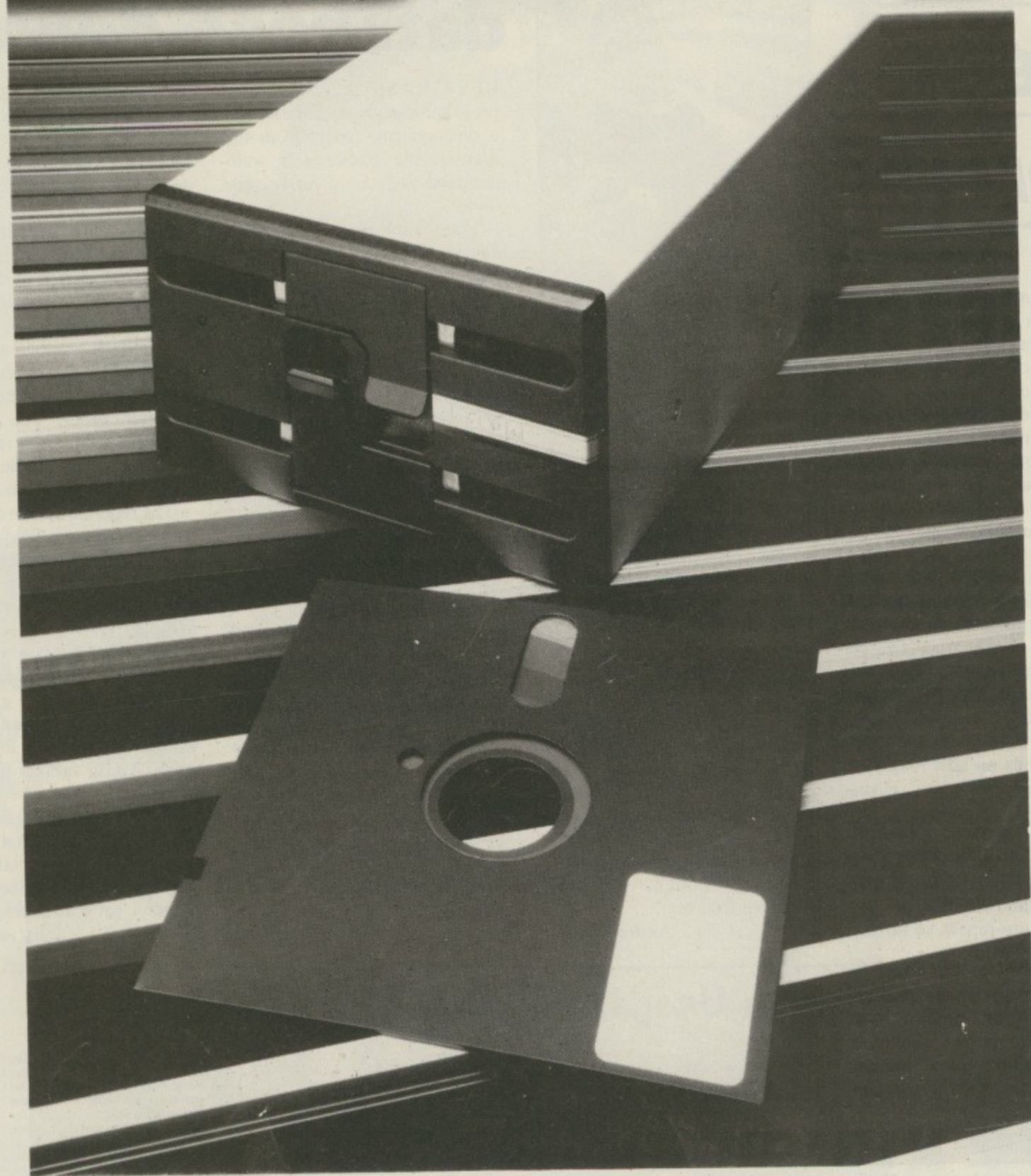

● Dual Drive ● BBC compatible ● Matching quality steel case ● Switchable 40/80 track ● Complete with utilities disc, manual, cables ● Runs off BBC power supply ● 5 1/4 in drive designed and built in Britain

★ TRK1 Dual Single Sided **£279**
★ TRK2 Dual Double Sided **£349**

★ DPSU1 separate Power Supply **£36**
★ Carriage **£8**

Tech OP Ltd.

Electronics and Physical Sciences

Access accepted. Prices exclude VAT.

19 Rodney Road, Cheltenham, Glos. GL50 1HX UK.
Tel: 0242 570999.

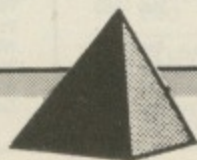

Print from Japan

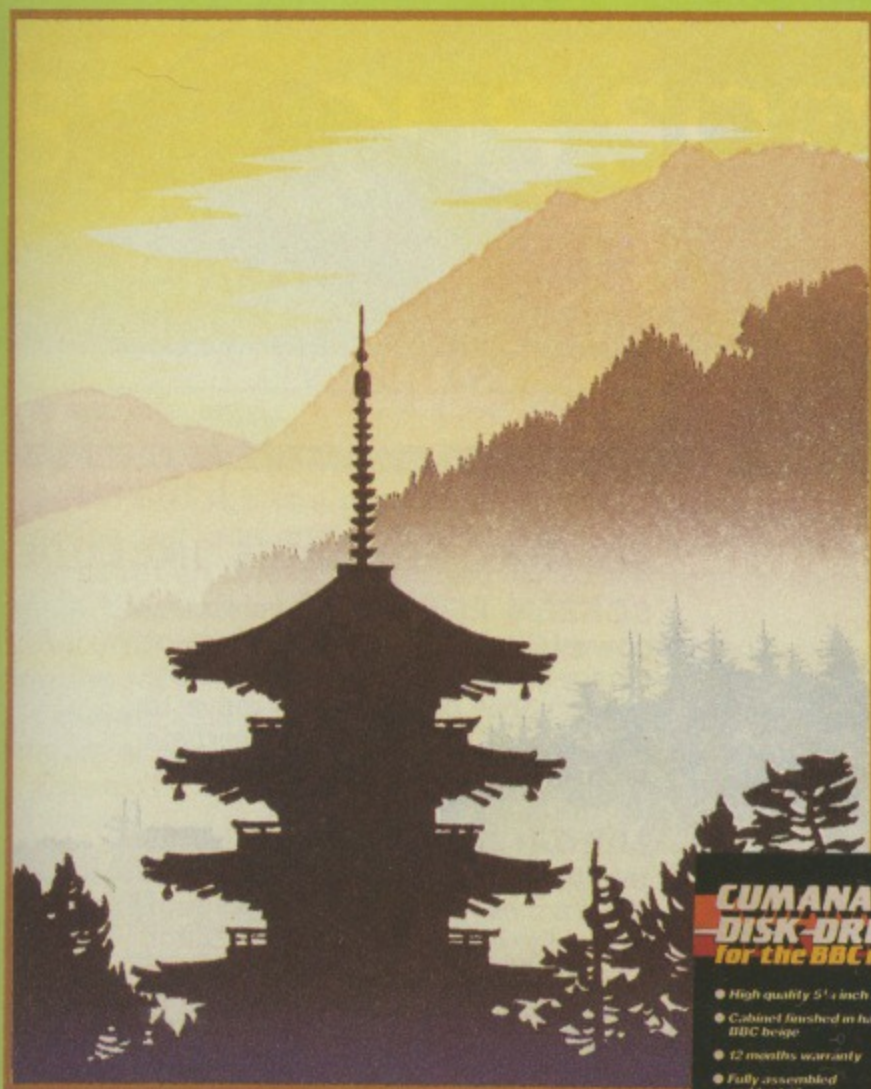

Disk Drives from Cumana



Like the beautiful prints from Japan, Cumana disk drives represent the very highest standards in design and production. Also like the prints, Cumana disk drives represent the highest state of the art; and they not only look beautiful, they perform beautifully as well.

Cumana disk drives for the BBC Microcomputer are available in slimline single, dual and dual switchable versions. They have 12 months warranty, are fully assembled and tested before packaging, and are available — at unbeatable value for money prices — from W. H. Smith, The John Lewis Partnership, Greens Leisure, Laskys, Spectrum UK, area distributors (see below) and Cumana's national dealer network.

Look out for the distinctive Cumana packaging in your high street, today!



Area distributors:

HCCS Associates (Gateshead) 0632-821924, Eltec (Bradford) 0274-722512, Basic Business Systems (Nottingham) 0602-819713, Walters Computer Systems (Stourbridge) 03843-70811, Microage Distribution (North London) 01-205 7688, J. S. Simnett Computers (South London) 01-541 1495, Gwent Computers (South Wales) 0633-841760, National Micro Centre (Stockport) 061-429 8080, Microworld (Edinburgh) 031-228 1111, Microtest (Cornwall) 0208-3171, DRG Business Machines (Weston-Super-Mare) 0934-415398, Kingdom Design (Belfast) 0232-643720, Hugh Symons (Bournemouth) 0202-26535, Audio & Computer Centre (Jersey) 0534-74000, Peco Electronic (London) 01-543 1030 (Brighton) 0273 688395/6, Clwyd Technics (North Wales) 035 283 766, + National Dealer Network.

The Highest State of the Art



Cumana Limited,
Pines Trading Estate, Broad Street,
Guildford, Surrey, GU3 3BH.
Telephone: Guildford (0483) 503121.
Telex: 859380.

For further information about Cumana disk drives for the BBC Micro, please complete and return this coupon.

Name _____

Address _____

Interests:

Home Use

Education

Dealer

Business

Tel. No. _____

MU9/84

Note: If dealer, please attach this form to your letterheading.

TOOLKIT ROM from BEEBUGSOFT

BASIC Programmer's Aid for the BBC micro

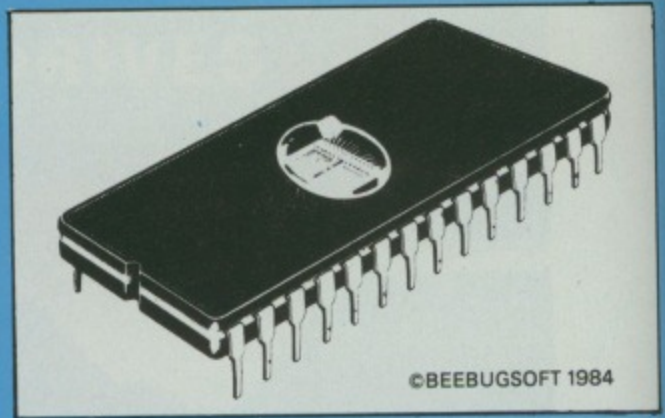

- 27 new commands to make life easier
- Saves hours in program development and debugging
- Supports both cassette and disc systems
- No command name conflict with other Roms
- Ideal for expert and novice alike
- Fitting instructions and a 32 page manual supplied
- You'll wonder how you ever managed without it

SPECIAL FEATURES INCLUDE

SCREEN EDITOR An extremely powerful editor, allowing the use of cursor keys to list a program line-by-line in either direction and move to any part of a program to overtype or insert new code and corrections.

ERROR DETECTION Powerful facility to trap an error in a Basic program as it runs. It will then automatically enter the Screen Editor, display the line in error and position the cursor close to the statement at fault.

"TOOLKIT is an essential utility for all Basic programmers using the BBC Micro. . . . The range is enormous. . . . an indispensable aid packed full of powerful utilities."

EDUCATIONAL COMPUTING MARCH 1984

"... highly recommended."

PCN MARCH 17 1984

"The Beebugsoft Toolkit costs £27 and in my opinion is worth every penny. Since it has been installed in my BBC it has been used extensively and I can find no fault with it. Highly recommended to lazy programmers!"

COMPUTING TODAY JUNE 1984

COMMANDS

*CHECK	Verify a program or data in memory with disc/cassette.
*CLEAR	Clear all variables including integers.
*EDIT	Enter full screen editor.
*FREE	Display free memory and pseudo variables.
*HELP INFO	Display a screenful of useful system information.
*MEMORY	Display memory contents.
*MERGE	Merge a program in memory with one on disc/cassette.
*MOVE	Move program to run at specified address.
*NEW	As NEW, but can be issued from within a program.
*OFF	Cancel enhanced error handling.
*OLD	As OLD, but can be issued from within a program.
*ON	Auto error handling—enters editor at line in error.
*PACK	Efficient program compactor.
*RECOVER	Intelligently recover bad programs.
*RENUMBER	Allow partial renumbering.
*REPORT	Extended error reporting facility.
*SCREEN	Screen dump to cassette or disc.
*UTIL	Display utilities menu.
*UTIL 1	String search.
*UTIL 2	String search and replace.
*UTIL 3	Move Basic program lines.
*UTIL 4	List procedures and functions.
*UTIL 5	List values of A% to Z%.
*UTIL 6	List numeric variables.
*UTIL 7	List string variables.
*UTIL 8	List names of arrays.
*UTIL 9	Set up range for utilities 1 and 2.

BEEBUGSOFT, PO BOX 109, HIGH WYCOMBE, BUCKS HP10 8HQ

Please send me.....Toolkit(s) at £27.00 each

Name

Address

Send Cheque/Postal Order to BEEBUGSOFT,
DEPT 16 , PO BOX 109, HIGH WYCOMBE, BUCKS HP10 8HQ
(Distribution agents for BEEBUG Publications Ltd.)

Available from your dealer
and selected branches of
W.H. Smiths

£27.00

Including
VAT & P&P



SERIOUS SOFTWARE from BEEBUGSOFT.

Masterfile

MASTERFILE is a general purpose data base, written especially for the BBC Micro. It is extremely useful, allowing vast amounts of information to be quickly stored.

Once set up, the information may be retrieved or sorted at any time, in a number of different ways, using any of the fields as keys.

Records may be instantly displayed or printed, using any printer suitable for the BBC Micro, also a label printing facility is included.

Separate versions of the program are available for cassette and disc based systems. The disc version uses random access files to maximise record storage.

One extra feature of the disc version is that it provides limited spreadsheet facilities.

Spellcheck

SPELLCHECK is menu driven, and is the ideal companion for **WORDWISE** or **VIEW**. It provides an automatic spelling check for letters or documents.

It is supplied with a dictionary disc already containing 6000 words, which may be increased to a maximum of about 17,000 words on a 100k disc.

Random access files ensure very fast word retrieval from the dictionary disc.

SPELLCHECK is menu driven, and is very simple to use, allowing unknown words to be added to the dictionary, ignored or re-spelt.

Incorrectly spelt words may be instantly respelt and a correct version of the document filed away, ready for printing or later use.

Dictionary discs for foreign languages may easily be created to help check letters sent abroad.

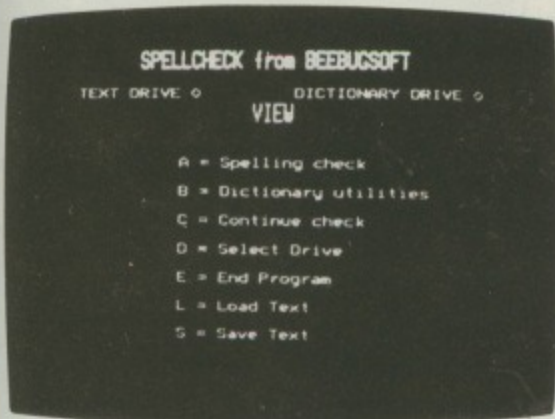

".... I found the program to be invaluable.... fast and reliable a worthwhile investment."

PCN FEBRUARY 1984

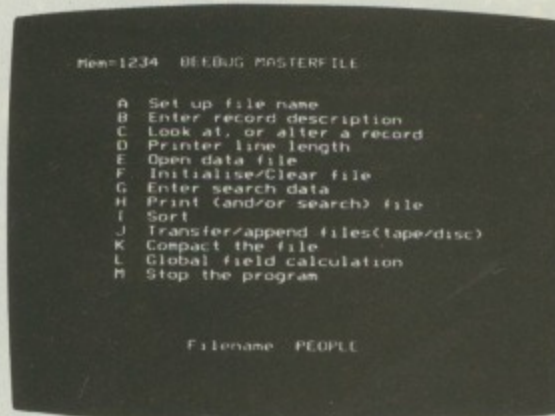

TECHNICAL INFORMATION

The cassette version will allow up to 10 fields to be specified per record. Any number of files may be set up, and each file may hold about 110 records (based on a typical 5 field record).

The disc version allows up to 17 fields per record, and the only limitation as to the number of records, is the capacity of the disc. Typically, using 5 fields, about 2000 records may be stored on a 100k disc.

".... Works well and offers an efficient data base...."

PCN NOVEMBER 1984

BEEBUGSOFT, P.O. BOX 109, HIGH WYCOMBE, BUCKS. HP10 8HQ

Please send me Spellchecks at £19.00 each. Masterfile disc(s) at £19.00 each.
Masterfile cassette(s) at £10.00 each.

Name

Address

All BEEBUGSOFT products are available from leading dealers including larger branches of W.H. Smith



Send Cheque/Postal Orders to BEEBUGSOFT, DEPT. 16 P.O. BOX 109, HIGH WYCOMBE, BUCKS. HP10 8HQ
 (Distribution agents for BEEBUG Publications Ltd.)

VILLAINS

By DEREK BENT



THE object of the game is to prevent your four giant Lidthium energy crystals from being stolen by villains intent on your destruction. You will also have to defend yourself against repeated attacks from assassins and Hugo, the mad professor. Your only weapon is a laser blaster.

The villains home-in on the energy crystals from any of the four corners of the screen. If they see one they run towards another corner of the screen where they dematerialise. Your aim - to stop them.

If you are hit by either an assassin or a villain your energy level decreases by one unit. You are slowed down if you are hit by Hugo's freeze ray.

It gets worse! You are destroyed if your energy level reads zero or if all of your energy crystals have been stolen.

Score 80 points for stopping a villain and 150 points for stopping an assassin and Hugo.

You get a bonus each time you clear a wave, and every three waves completed your energy and speed of movement are restored.

Listing starts
on Page 161

VARIABLES

gold%	Flag for each of the crystals that indicates whether a particular crystal has been stolen.	men%	Number of units of energy remaining.
xpos%	X coordinates of the left and right corners of the screen from which the villains appear.	print%	Determines which of the crystals is printed any one loop of the program.
ypos%	Y coordinates of the top and bottom corners of the screen from which the villains appear.	score%	Player's present score.
X%	X coordinate of the player's man.	hugo%	Used inside PROC Hugo. Number of loop procedure does before Hugo attacks the player's man.
Y%	Y coordinate of the player's man.	C%	Used by PROC movex. Contains the value added to the man's X coordinate. Determines which user-defined characters, for the player's man, are used, depending on which the man is pointing.
goldpos%(,1)	X coordinate of each of the crystals on the screen.	killed%	Remaining number of villains, assassins and Hugos to be killed before a wave is completed.
goldpos%(,2)	Y coordinate of each of the crystals on the screen.	waves%	Number of waves completed.
x%	X coordinate of the villains, the assassins and Hugo.	dist%	Distance the assassins can venture in from the sides of the screen.
y%	Y coordinate of the villains, the assassins and Hugo.		



ning.
is printed
r of loops t
ks the playe
ns the val
dinate. Al
racters, for t
on which w
assassins a
is complete
e in from t

THIS
HI%
col%

Names of players on the high score table.
Scores of players on the high score table.
Major general variable used in the program.

PROCEDURES

PROCinit

Defines characters used for the various parts of the villains, the player's man and the crystals. Also defines the sound envelopes and dimensions the various array variables.

PROCvar

Assigns initial values to the main variables used in the program.

PROCscreensetup

Draws screen and sets up a graphics window. Displays all the crystals and draws the player's man in the centre of the screen.

PROCscore

Displays present score at top of screen.

PROCKey

Takes inputs from the keyboard and assigns the appropriate move procedures.

PROCmovex

Updates X position of player's man unless at edge of screen.

PROCmovey

Updates Y position of player's man unless at edge of screen.

PROCgun

Fires laser in the direction the player's man is pointing. Checks to see if anything has been hit.

PROCvillain

Contains the loop for the movement and the actions of the villains.

PROCassassin

Contains the loop for the movement and the actions of the assassins.

PROChugo

Contains the loop for the movement and the actions of Hugo.

PROCgameover

Draws a sunburst type explosion over the player's man.

PROChitable

Displays high score table.

M
E
X
I
C
O
M
I
C
S

The Definitive 24K ROM based Random Access Database Management System for the BBC Micro.

DATA

GEMINI



DataGem is here! The most comprehensive Database Management System ever written for the BBC Micro, allowing up to 5100 user definable records. Facilities are also included for interfacing with 'Wordwise' and 'View' word processors.

DataGem will not work with cassette based systems and requires a model B BBC Micro computer fitted with at least one disk drive and operating system 1.2 or greater. Use of a printer is optional.

Write to or telephone Gemini for further information, or complete the coupon below. Stock subject to availability

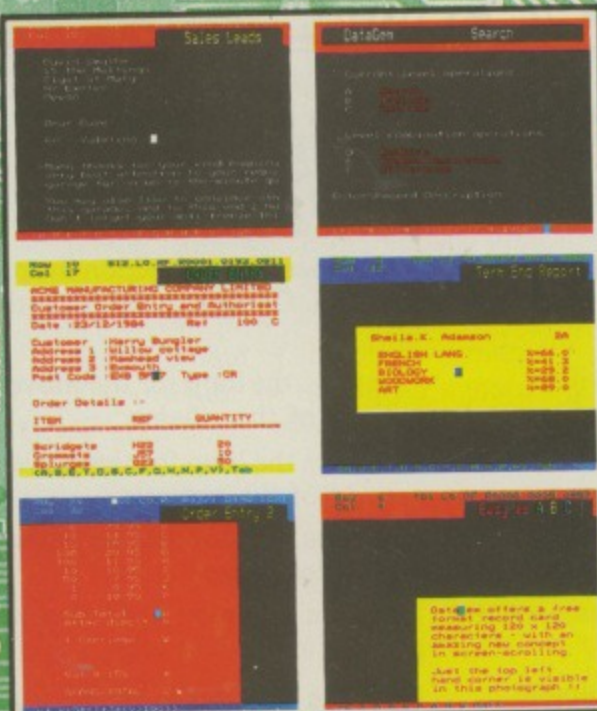

GEMINI

MU

18a Littleham Road, Exmouth, Devon EX8 2QG England

AVAILABLE FROM:

Larger branches of Boots and W.H. Smith and most good software dealers... or phone Gemini for immediate despatch quoting your Access, Visa or American Express card number. Telephone (0395) 265165/265832. Alternatively make your cheque or Postal Order payable to Gemini Marketing Ltd., and send to Gemini Marketing Ltd., 18a Littleham Road, Exmouth, Devon EX8 2QG.

Please send urgently..... DataGem(s) @ £129.95.
Prices stated include VAT and Post and Packing (UK only)

Name

Address

Signature

Credit Card No. Access/Visa/American Express

M
t
o.

MEMOTECH BBC CBM64 SPECTRUM ORIC1 LYNX NASCOM ATARI

Trapped in a fiendish Level 9 Adventure?
Your lamp burning low? Every exit guarded?

You need escape plans! Send for one of Level 9's great new clue sheets for help. The clue sheets are free and each answers hundreds of questions: follow the instructions supplied with your adventure to get one. (Don't forget to send a stamped self-addressed envelope and tell us which game you have.)

NEW REVIEWS: "Level 9 are fast establishing a name for themselves among computer adventurers as the Number 1 producers of quality adventure software. All their adventures are text only, but because of a special coding they have developed, the amount of description and the number of locations packed in 32K is truly amazing."

— Midweek, 10 May 84

"Quicksilver call themselves the 'Game Lords'. That might be open to argument. But there can be no doubt that Pete Austin and the team at Level 9 are the 'Lords of Adventure'.

— Central Press Features, April 84

"Play Lords of Time and get nine times the pleasure!"

— Your Computer, May 84

AVAILABLE FROM: WH Smith and good computer shops nationwide.

If your local dealer doesn't stock Level 9 adventures yet, ask him to contact us or: Centresoft, Drake Distribution, Ferranti & Craig, Hi-Tech, Lime Tree, Microdeal, R&R or Wonderbridge.

Level 9 Computing

- Colossal Adventure: the original mainframe adventure with 70 extra locations
- Adventure Quest: an epic journey across the weird landscape of Middle Earth
- Dungeon Adventure: a truly massive game which completes the Middle Earth Trilogy
- Snowball: could this be the biggest SF adventure in the world?
- Lords of Time: an imaginative romp through World History

I ENCLOSE A CHEQUE/PO FOR £9.90 EACH

My name:

My address:

My micro is a:
(one of those listed on the arch above, with at least 32K of memory).

Contact:

LEVEL 9 COMPUTING

Dept. U, 229, Hughenden Road
High Wycombe, Bucks. HP13 5PG
Telephone: (0494) 26871

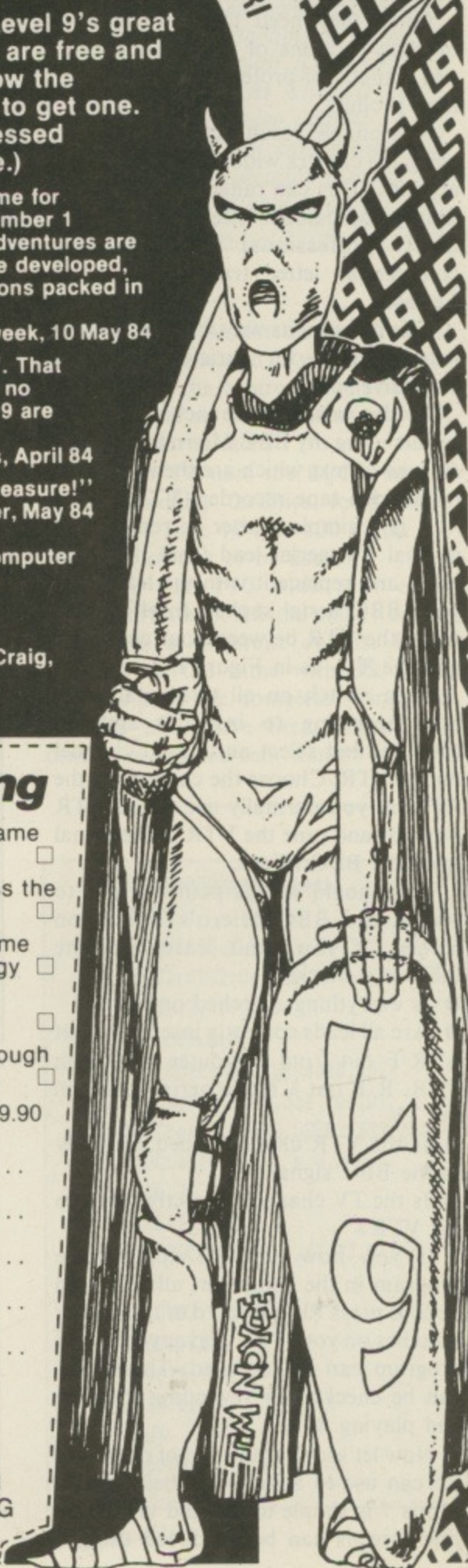
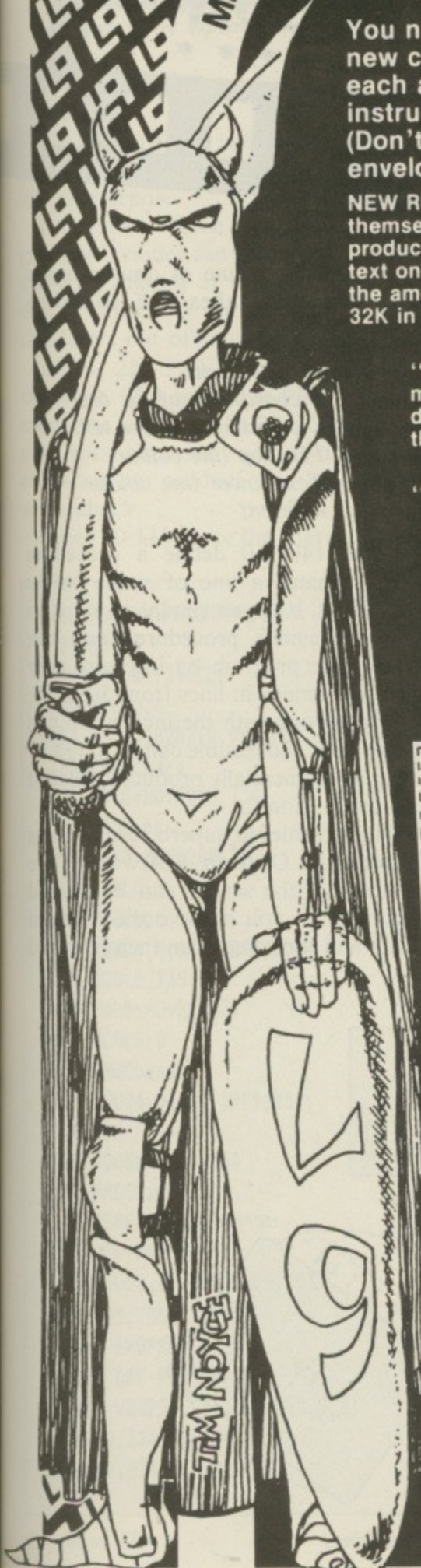

MB8118-10
8337 171
MB8118-10
8337 171
MB8118-10
8337 171

ALAN McLACHLAN demonstrates how to create titles for your home video

AS the video recorder becomes a standard feature in the average household, those fortunate enough to own cameras are naturally producing homemade video films.

Often they need to create suitable opening captions or closing credits to add a touch of professionalism to their final product.

Reasonable results can be obtained using the camera with suitably prepared artwork. This can range from freehand drawn and painted letters to work of a highly professional standard using commercial letter transfers such as Letraset.

This is fine in its way, but the range of letters needed for variety can prove expensive.

In the past I have achieved good results using my BBC Micro to generate screens of text which are then recorded on a video tape recorder (VTR).

It is a simple matter to remove the normal TV aerial lead from the VTR input and replace it with the lead from your BBC aerial socket. In effect you insert the VTR between your computer and the TV, as in Figure 1.

Then switch on all three machines, not forgetting to insert a suitable cassette, and select an unused channel on the VTR. Choose the channel on the TV that you normally use as the VTR monitor and tune the VTR to the signal from the BBC Micro.

You should at this point be able to obtain the BBC Micro's switch on screen. If you can't, carry out the following checks:

- Is everything switched on?
- Are all leads correctly inserted? That is, R/F out from computer to R/F in VTR, R/F out VTR to aerial socket in the TV.
- Is the VTR channel tuned correctly to the BBC signal?
- Is the TV channel correctly tuned to the VTR?

If you now run the appropriate program in the computer, all you need to do is press Play/Record or the similar switches on your VTR and any length of program can be recorded. The results can be checked by rewinding the tape and playing it.

Now let's look at the sort of programs we can use to achieve the best results. Mode 7 is simple to use and very good title screens can be produced using a



combination of single and double height characters as in Program 1.

Lines 100-130 define a procedure

```

10 REM ***PROGRAM 1***
20 CLS
30 VDU23;8202;0;0;0;
40 A=BET
50 PROCdbltext("St.
Peters",12,6,129,131)
60 PROCdbltext("S C H O O L   S P
O R T S   D A Y ",1,12,131,131)
70 A=BET
80 PROCsngltext("Friday 29th June
1984",7,20,135)
90 REPEATUNTIL0
100 DEFPROCdbltext(msg$,XZ,
YZ,CZ,DZ)
110 PRINTTAB(XZ,YZ)CHR$141;
CHR$CZ;msg$
120 PRINTTAB(XZ,YZ+1)CHR$141;
CHR$DZ;msg$
130 ENDPROC
140 DEFPROCsngltext(msg$,VZ,WZ,CZ)
150 PRINTTAB(VZ,WZ)CHR$CZ; msg$
160 ENDPROC

```

Program 1

which creates a line of double height characters. It takes the following parameters:

msg\$ Text content
X% X coordinate of the text
Y% Y coordinate of the text
C% Text top line colour
D% Text lower line colour
different

Lines 140-160 define a procedure which creates a line of single height characters. It passes similar parameters to the previous procedure. You can modify the program by inserting your own text strings in lines from 50 to 90.

For anyone with the inclination and funds, time and trouble can be saved by using a commercially produced Teletext on-screen editor.

I have achieved superb results using Dtext by Optima Software. The contents of the screen can be pushed around until you achieve the required result and the screen can then be saved

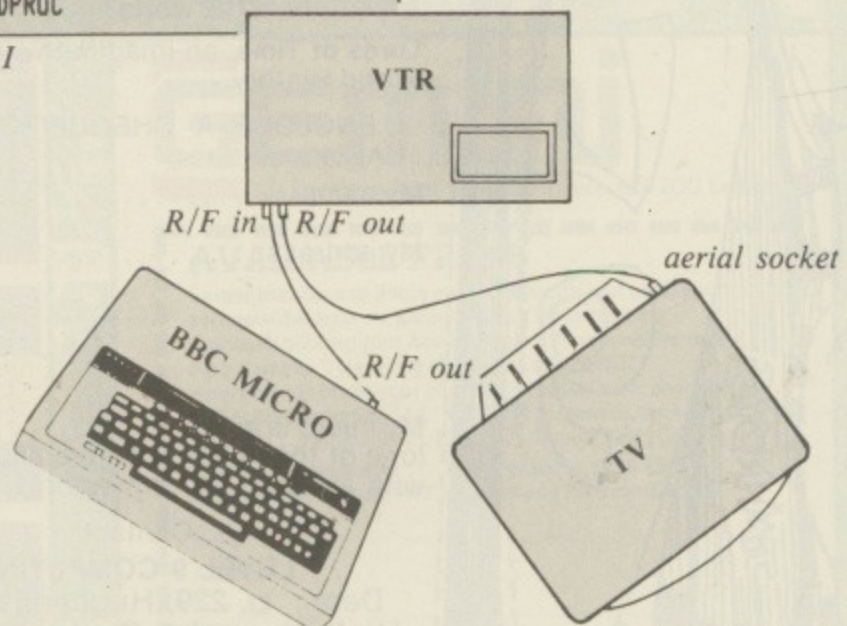

Figure 1: Connecting up the three machines



Datext by Optima Software

as a program and recalled under key control.

The screen editor in the August 1984 issue of *The Micro User* is also suitable for this purpose.

Programs which use the BBC's graphics facilities can be written in other modes. Program II demonstrates the use of Mode 5 by creating large characters out of square blocks.

Lines 220-240 define the block character. This is used in PROCbbc to create the large text. In PROCband it is used again alternately with an undefined character to produce the black and white check.

Lines 30-110 place the characters on

The BBC, in common with other systems, has both RF (normal TV), and video outputs. The results from the video output are of a much better quality, but its uses are somewhat restricted and the benefits will only be noticed with the use of a monitor.

Regrettably, without modification the BBC video output is black and white. However the modifications are quite simple and depend on the issue of board in your micro. In order to achieve colour output a link must be made at S39.

On boards from issue 7 onwards this is done by sliding a shorting connector over the two pins at this location. On earlier boards the modification is a little more complicated and fiddly.

The modification was explained in detail in an answer section of the August 1983 issue of *The Micro User Micromail* (Colour Clue, Page 107).

All you need to do is to connect a 56 picofarad capacitor between R123 and Q9.

Solder one end to the resistor and put a piece of insulation sleeving over the other before attaching it to the emitter of the transistor. The results of both operations should be identical - colour video output.

If you do not feel competent to carry out this modification yourself, your dealer will be able to do it.

screen using two separate text graphic windows.

Program III demonstrates a simple use of Mode 5 text but printed on the graphic screen using MOVE and VDU5. This enables better centring of odd numbered characters on a screen with an even number of TAB positions.

When the REM statements at lines 50 and 60 are removed a vertical line is drawn down the centre of the screen - an invaluable aid when centring text. It can be removed later.

Program IV uses the BBC's superb string handling facilities to produce animation. Line 90 and 100 define the two lines of text to be used.

Lines 110-190 pick out each individual letter of AS and place it on the screen in a different colour. Lines 220-300 do the same with BS. Lines 340-440 take the complete strings AS and BS and move them toward the centre of the screen. Lines 490-579

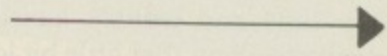

```

10 REM ***PROGRAM II***
20 MODE5
30 COLOUR134:CLS
40 GCOL0,0
50 VDU23;8202;0;0;0;0;
60 PROCchars
70 VDU5:MOVE250,734
80 PROCbbc
90 VDU5:MOVE280,762
100 GCOL0,1
110 PROCbbc
120 VDU24,0;146;1279;300;
130 GCOL0,135:CL6
140 VDU5:MOVE0,300
150 GCOL0,0
160 PROCband
170 VDU24,0;800;1279;954;
180 CL6
190 VDU5:MOVE0,954
200 PROCband
210 REPEATUNTILO
220 DEF PROCchars
230 VDU23,224,255,255,255,
255,255,255,255,255
240 ENDPROC
250 DEF PROCbbc
260 VDU224,224,224,224,8,8,
8,8,10,224,9,9,224,8,8,
8,8,10,224,224,224,224,
8,8,8,8,10,224,9,9,224,
8,8,8,8,10,224,224,224,224
270 VDU224,224,224,224,8,8,
8,8,10,224,9,9,224,8,8,
8,8,10,224,224,224,224,
224,8,8,8,8,10
280 VDU224,224,224,224,8,8,
8,8,10,224,8,10,224,8,
10,224,8,10,224,224,224,
224,8,8,8,8,10
290 ENDPROC
300 DEF PROCband
310 VDU224,255,224,255,224,
255,224,255,224,255,224,
255,224,255,224,255,224, 255,224,255
320 VDU255,224,255,224,255,
224,255,224,255,224,255,
224,255,224,255,224,255, 224,255,224
330 VDU224,255,224,255,224,
255,224,255,224,255,224,
255,224,255,224,255,224, 255,224,255
340 VDU255,224,255,224,255,
224,255,224,255,224,255,
224,255,224,255,224,255, 224,255,224
350 VDU224,255,224,255,224,
255,224,255,224,255,224,
255,224,255,224,255,224, 255,224,255
360 ENDPROC

```

Program II

```

5 REM***PROGRAM III***
10 MODE5
20 COLOUR135:CLS
30 VDU23;8202;0;0;0;0;
40 VDU19,2,4,0,0,0
50 REM GCOL0,0
60 REM MOVE640,0:DRAW640,1024
70 PROCtext("THE",552,700,0)
80 PROCtext("MICRO USER",332,600,0)
90 PROCtext("p r e s e n t
s",190,400,2)
100 REPEATUNTILO
110 DEFPROCtext(msg$,XZ,YZ,CZ)
120 VDU5
130 COLOUR3
140 GCOL0,CZ
150 MOVEXZ,YZ
160 PRINTmsg$
170 VDU4
180 ENDPROC

```

Program III

From Page 103

repeat the procedure but in a vertical direction.

You can adapt these programs to your own use by changing the string contents in Programs I, III, and IV, or by altering the shape of the big letters in Program III.

If you have access to sophisticated editing equipment – or just a second VTR – it wouldn't matter in which order you recorded your items.

Selected sections of film, captions or otherwise, can be edited sequentially on a new tape with surprising ease by connecting one VTR directly to another, using one as a source on Play and the other as a target on Record.

Naturally there will be some deterioration in the rerecorded material but this will not be excessive.

I have been fortunate in the past to have use of a Panasonic home video console which not only allowed picture editing at the touch of a button, but permitted sound mixing as well.

Without sophisticated facilities you must record your items in the order that they will be required in the finished product:

- Record opening title from BBC.
- Record film on camera
- Record final credits/The End.

As you can well imagine, this calls for a lot more preparatory work in order to save time and trouble later. But it is worth spending that little bit longer with

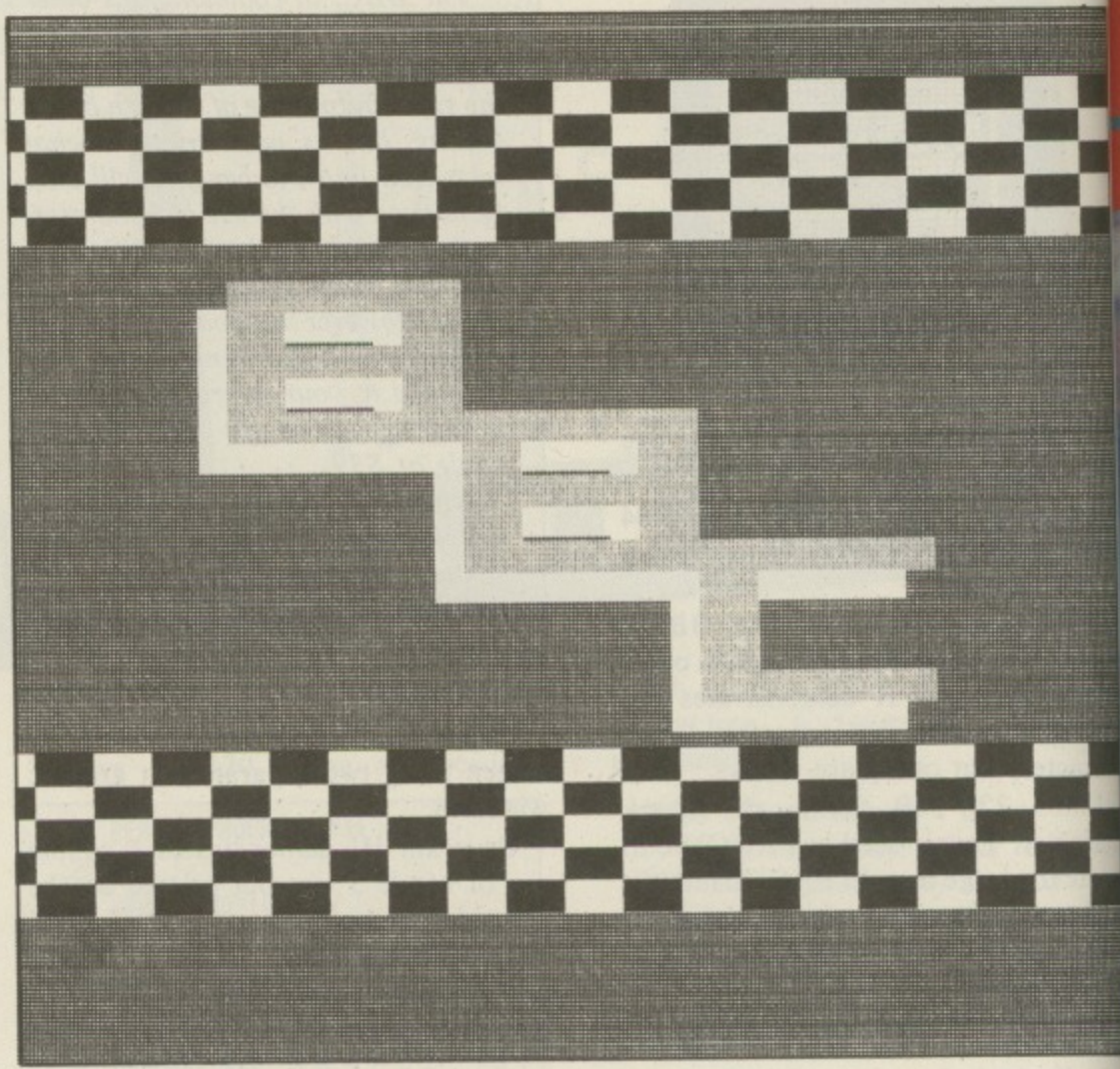

a pencil and paper deciding the correct order and length of your items.

Although I have only described simple ways of producing captions, there is still plenty of room for experiment. I have achieved excellent results using these methods – and it really can be quite good fun and

extremely rewarding.

You could even create animation by clever manipulation of the Record/Pause buttons and several screens of characters and text.

I haven't tried this and would advise you to attempt the simpler techniques first.

```

10 REM***PROGRAM IV***
20 MODE5
30 COLOUR131
40 VDU23;8202;0;0;0;
50 VDU19,2,4,0,0,0
60 CLS
65 A=GET
70 XZ=12
80 CZ=0
90 A$="ANIMATED "
100 B$="CAPTIONS"
110 FOR AX= 1 TO LEN(A$)
120 COLOURCX
130 AA$=MID$(A$,AX,1)
140 PRINTTAB(XZ,12),AA$
150 XZ=XZ+1
160 FOR DX=1 TO 1000:NEXT
170 CZ=CZ+1
180 IF CZ>2 CZ=0
190 NEXT
200 A=GET
210 SZ=0
220 FOR AX= 1 TO LEN(B$)
230 COLOURCX
240 BB$=MID$(B$,AX,1)
250 PRINTTAB(SZ,16),BB$
260 SZ=SZ+1
270 FOR DX=1 TO 1000:NEXT
280 CZ=CZ+1
290 IF CZ>2 CZ=0
300 NEXT
310 A=GET
320 XZ=12
330 REPEAT
340 PRINTTAB(XZ,12),A$
350 FORDX=1 TO 1000:NEXT
360 XZ=XZ-1
370 UNTILXZ=5
380 SZ=0
390 REPEAT
400 PRINTTAB(SZ,16),B$
410 PRINTTAB(SZ-1,16)," "
420 SZ=SZ+1
430 FOR DX=1 TO 1000:NEXT
440 UNTILSZ>6
450 A=GET
460 YZ=14
470 ZY=18
480 REPEAT
490 COLOUR0
500 PRINTTAB(6,YZ-4),A$
510 PRINTTAB(6,ZY),B$
520 PRINTTAB(6,YZ-3),STRING$(8," ")
530 PRINTTAB(6,ZY-1),STRING$(8," ")
540 YZ=YZ-1
550 ZY=ZY+1
560 FORDX=1 TO 1000:NEXT
570 UNTILYZ<8
580 VDU19,0,8,0,0,0
590 REPEATUNTIL0
    
```

Program IV

Log-on

Plug into the
exciting world
of telecomputing!



on by
cord/
ns of
advise
iques

The binary beacons are lit..

DATA communication, in one form or another, has been around as long as man has.

The earliest forms of long distance communications worked on a binary system. The beacons built to warn of the Spanish Armada were capable of transmitting a single binary bit – invasion on, lit.

The American Indians with their smoke signals added a little variety by transmitting a series of different shapes of smoke columns.

Even the jungle drums of Africa used rhythms to convey messages.

All these systems were a little limited because the patterns transmitted conveyed whole messages. The breakthrough came when the letters of an individual language were broken down and given their own unique code.

Perhaps the first to do this was the navy with its semaphore flags. In this system two flags can be held in one of six positions, thus giving enough combinations for the whole alphabet.

The advent of electrical means of sending data vastly increased the distance over which it could be sent. This however called for new methods of serialising data.

I am sure you have all seen the Westerns where the town is connected

By MIKE COOK

to the outside world by a single telegraph wire. It was always cut just before the bank was robbed.

In the early telegraph systems this single wire could carry current or no current – another binary system.

Each letter was therefore broken down into a series of long and short duration current pulses known as dots and dashes.

This was known as morse code – not that Samuel Morse invented it, just that he had the money to back it.

The electric telegraph and the morse code it used were in fact invented by an eccentric Englishman, Sir William Fothergill Cook (*to the best of my knowledge no relation*).

As the demand for communications grew, it became apparent that morse code was not the most efficient method as it took a trained operator to use it. What was needed was a system for untrained people.

Many patents and ingenious devices attempted to decode morse code mechanically. But it was not until decades later with the advent of



computers that this could be fully realised.

The snag was that morse was designed to be learned by a person, not by a machine – different letters contained differing numbers of elements and lasted for differing times.

To overcome this people decided to invent a machine-based system. This was done by an American called Baudot.

His system consisted of five piano type keys, three for the right hand and two for the left. When the keys were depressed an ingenious system of cogs, clutches and cams scanned the keys and keyed the line.

At the remote end an even more ingenious mechanical spaghetti manoeuvred a cylindrical printing head so that the correct letter was typed on paper.

This system still took a trained operator at the sending end, as the keys to press for any letter had to be learned. But it did represent a vast improvement.

It so affected Americans that they still call five bit data codes "Baudot code" even though that has not been used since the 1914-18 war.

An English engineer called Murray took the next big step by inventing an asynchronous form of data transmission which is very similar to that used in modern computers.

It was designed to be used with punched tape, the code being arranged so that the most frequently used letters had the fewest holes, thus improving the strength of the tape.

It was also possible to rub out a character by making all the paper tape positions into holes. In this way errors could be corrected before transmission.

The transmission mechanism consisted of a three row keyboard and a paper tape reader. The keys were in the conventional Qwerty sequence with the numbers shifted above the Qwerty keys on the top row.

The transmission line could be in two states. Today we call them logic levels zero or one, but the early telegraphers referred to the states of the line as mark and space.

Mark was the natural state of the line and a space the driven state.

Each character starts by the line being driven to the space state for one unit of time. This is known as a start bit as it signifies the start of each character. The data is then sent in the next five time slices.

The line is placed in the mark state and the next start bit can begin when it has been in this state for at least one and a half time slices. This is shown in

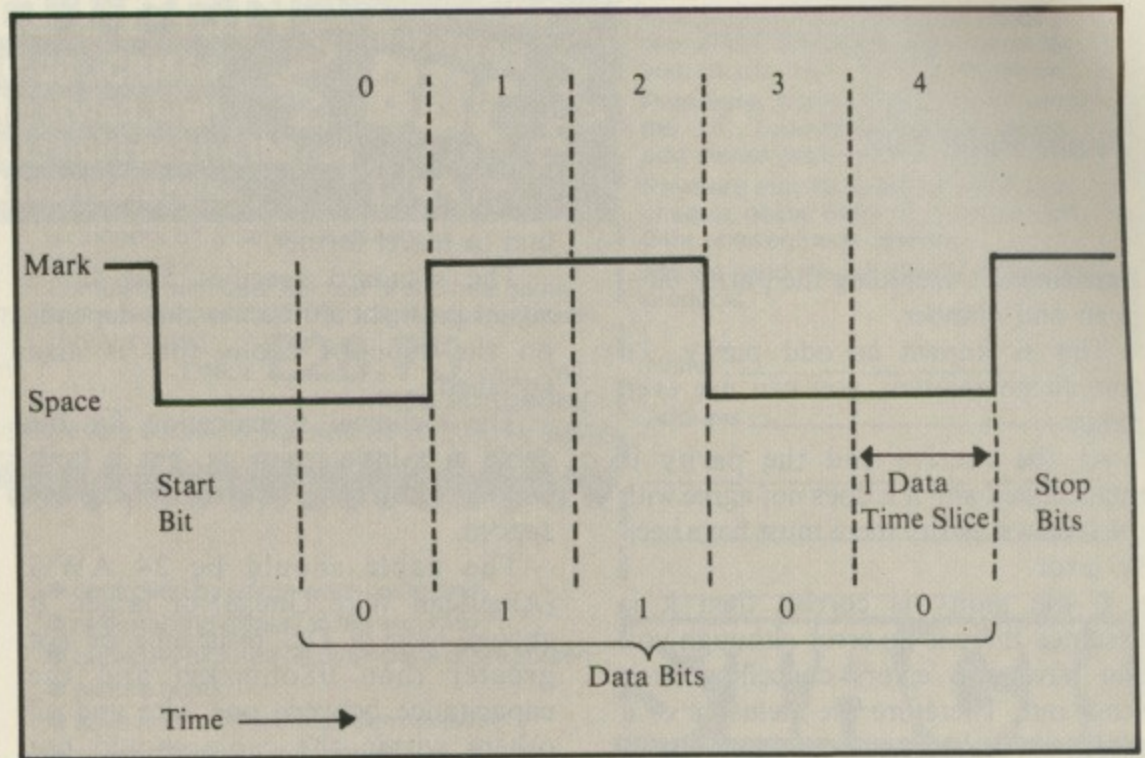

Figure 1: Asynchronous five bit data.

Figure 1.

The format of the data is said to be one start bit, five data bits and one and a half stop bits.

The time of each data element had to be long enough for cogs and clutches to engage, and so these early machines were limited in speed. They usually ran at 50 baud.

A baud is one data time slice per second, with seven and a half bits making up a character. This works out at about six and a half characters per second, a little slower than a competent typist.

As there were five data bits, only 32 different code patterns could be generated. This is not enough for all the letters of the alphabet together with the numbers and punctuation, so the concept of control codes was introduced.

On receipt of a letter shift code all subsequent codes were treated as letters. To print numbers and punctuation a figure shift code had first to be sent.

This code was known after its inventor as Murray code, although the Americans still called it Baudot code. A very similar code is still in use today on the Telex network.

Only a few characters have been changed since Murray's original code. People sometimes wrongly call it Murray code and the Americans still insist it is Baudot, although officially it is ITU Telegraph Alphabet No 2.

Many early computers used five-unit codes and modified teleprinters to communicate with the users. Names like Elliot 803 auto code still bring wistful smiles and nostalgic sighs to programmers with over 20 years in the business.

Most of the earlier computer manufacturers agreed to adopt a standard method of coding their data. The exception was IBM which decided to go it alone with its own codes.

Being big enough to do this, IBM forced the user to buy from them. Everybody else decided to adopt Ascii (American Standard Code for Information Interchange). Ghastly isn't it, but it improves if you say it with a mid-south cotton picking accent.

Ascii – pronounced Askey, as in Arthur – is a 7 bit data code employing a start bit and one or two stop bits.

There are codes for all the letters and numbers as well as punctuation and other symbols. There are also codes to control the action of a mechanical terminal.

As most terminals are now visual display units a lot of the original definitions do not make sense, so various manufacturers have interpreted them to have various effects such as flashing characters.

This produces incompatibilities in what is supposed to be a compatible system. If you look at the VDU commands on the BBC Micro you will see how these control codes have been interpreted by Acorn. They exploit the unique features of the BBC Micro.

With the advent of micros and their 8 bit data buses, serial data with 8 bits became more popular, as it is convenient to transmit a byte in one word. Also parity has been included.

Parity is an extra bit set in such a way that the total number of mark states

From Page 107

transmitted – including the parity bit – is an odd number.

This is known as odd parity. To complicate matters, you can use even parity.

At the receive end the parity is recalculated and if it does not agree with the received parity there must have been an error.

If the parity is correct then it is assumed there is no error although you can have two errors cancelling each other out. Therefore the inclusion of a parity bit makes some combinations of bits or codes not valid, or as we say redundant.

Thus in any serial system both transmit and receive both have to be set to the same word format – number of data bits, number of stop bits and odd, even or no parity.

The other aspect of serial data transmission which needed standardising was the physical state of the transmission lines for mark and space.

Early machines used a current loop system. A 20mA was the common standard. This had 20mA flowing round the circuit in one direction for a mark and in the reverse direction for space.

The current was used to drive a relay which operated the electro-mechanical clutches.

As this is a constant current system the driving voltage has to increase sufficiently to get the required amount of current flowing.

On a short line this is not very much, but on a long line or under open circuit conditions it could rise to about 180 volts, enough to give you a nasty shock.

With the advent of non-mechanical terminals this current was not needed, so a voltage standard arose. This is the RS 232, which not only specifies the voltage levels for mark and space but also specifies what plug to use and what signals are on what pins.

A space is represented by any voltage between 3 and 15 volts, but most people use 12 volts. A mark condition is represented by a negative voltage of the same size.

The RS423 system used by the BBC Micro is an improvement on the RS232 while still being compatible under most circumstances.

The RS423 has a space being represented by any voltage between 0.2 and 6 volts and a mark being the same in the negative direction.

It is an improvement as the impedance of the lines is lower, allowing signals to be less prone to interference and to travel further.

The standard specifies how far a signal path should be. As this depends on the type of cable, this is also specified.

The technical specification for the cable is a little technical, but it boils down to not being too thin or closely spaced.

The cable should be 24 AWG (American Wire Gauge) or larger. It should have a DC resistance of not greater than 98ohm/km and the capacitance between one wire and all others within the cable should not exceed 131 pF/m.

Using a cable of this sort with a data rate below 1,000 baud the system should be capable of being used over 1,000 yards.

As the data rate goes up this distance drops, so that at 10,000 baud it is down to 100 yards. Remember, this is with a standard cable.

As well as the signal path, this standard also specifies other protocol or handshaking signals. These are mainly designed to be used by a modem for telephone conversations.

The BBC Micro provides only two – an RTS (request to send) and a CTS (clear to send).

Just to confuse matters these are the reverse logic sense of the data. This means that when the signal line is active – that is, making a request to send data – it has a positive voltage on it.

The names of the signals are self explanatory. RTS says: "I want to send some data", whereas CTS is saying: "You are clear to send me some data". So RTS is an output and CTS is an input.

Confusion arises because you must always connect an input to an output. However the RTS line must always be connected to the same pin on the socket according to the standard. Therefore on some equipment RTS is an input receiving the request from the transmitter.

In order to know which way round to connect things you have to know whether your equipment is considered to be Data Terminal Equipment (DTE, where RTS is an output) or Data Communications Equipment (DCE, where RTS is an input).

When there were only mainframe computers to worry about it was all very simple. The computer and the terminal were DTE and the two modems

connecting them were DCE.

However with the advent of micros people wanted to connect the computer directly to the terminal, and so some makers configured their computers as DCE.

This allowed a normal lead to be used. However if a computer is configured as DTE then a special cable has to be used with crossover connections. For example, pin 4 on one plug would connect pin 5 on the other.

This confusion also applies to the two data lines labelled Transmitted Data (output on DTE) and Received Data (input on DTE).

It is hardly surprising then that sometimes the only way to find out is to experiment.

Some of this confusion is avoided on the BBC Micro by the "special feature" of not having a standard plug. This plug is capable of being inserted in two ways in the socket.

It would have been nice if this would swap over the appropriate signals, but for some reason it was not wired up that way.

The really useful aspect of having a standard (of sorts) interface built into your computer is that you can communicate with other machines of the same or different sort.

I have transferred programs from my TRS-80 into the BBC machine via this route. As the Basic is very similar, programs would run provided there were no graphic commands (in effect trivial programs).

Also the screen width is different, and so screen formatting is wrong. However it has been of significant use when transferring data files between machines.

When information in the form of the written word is required computer compatibility does not matter.

It is possible to "talk" to computers all over the world. You can extract information from them or leave messages on them.

The methods of communications are very much more efficient and sophisticated now than they have ever been. However that is not to say we have anything useful to say to each other.

As an example of this, just after the 1984 budget I logged onto the Prestel computer only to be informed there was a new message for me. It was from a wine merchant offering wine at "pre-Budget prices".

Well wine came down in the Budget, so he was either very stupid or very clever. Think about it!

STACK LIGHTPEN

100

ATARI...VIC-20...CBM 64
A beautifully styled, high
quality colour light pen for the
BBC, with touch controls.

NEW RELEASE
BBC

Easy to use...simply hold the LIGHT PEN against the T.V. screen, place a finger on the 'Touch Contact' and the pen is working. You can produce programs in which the LIGHT PEN places data (alphanumeric or graphical) onto the screen, removes data from the screen

or triggers off a series of events or instructions. Complete with user manual and a free game on cassette (worth £5.75) to get your software library started.

ONLY £28.75 incl. VAT
FREE POSTAGE!!

Stack Products are available from selected branches of: GREENS DEBENHAMS, DIXONS, JOHN MENZIES, SPECTRUM, W.H. SMITHS

HOW TO ORDER

Most computer dealers either stock or can obtain **STACK 100** products for you, or you may order direct from us. Packaging and postage is FREE within the U.K., overseas customers please add airmail postage.

Payment may be made by sending a cheque, postal order or by credit card, 24hr answerphone service.

Please send me full details of your BBC products.

Name _____

Address _____

GRAPHIX-ED

An excellent colour graphics program for your BBC. Easy to use, but be warned, any slight interest in graphics can quickly become an addiction!

- use normal, medium or hi-res graphics
- choose 1, 4 or 16 colours

- controlled by single letter commands
- optional grid display to aid accuracy
- duplicate pictures on other parts of the screen
- picture buffer
- save and recall pictures from cassette
- comprehensive user manual
- quick reference guide to commands

THE COMPLETE PACKAGE COSTS **£9.00** incl. VAT

BBC JOYSTICK

Full joystick control — in any direction — and it fires too!!

ONLY £13.80 incl. VAT

STACK 100

FREEPOST
BOOTLE, MERSEYSIDE L20 0AB

051 933 5511

24hr answerphone

KAY-ESS

COMPUTER PRODUCTS

PROFESSIONAL
PROGRAMS FOR
THE MODEL B
AND ELECTRON

EACH TAPE ONLY £5.95 (Except H.O.H.)

HOUSE OF HORRORS (B)(E) £6.95.

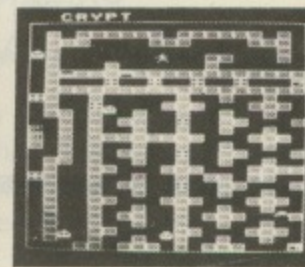
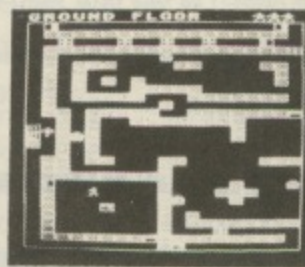
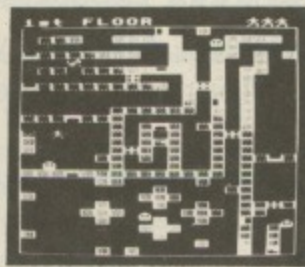
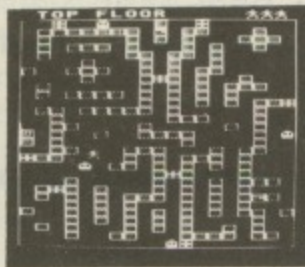
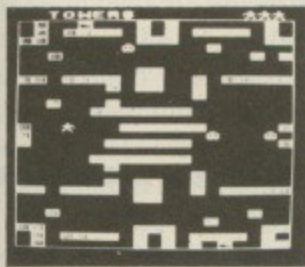

Turn off the lights and gather around for the most creepy game of the year. How you laughed at those superstitious fools in the village when they warned you not to go near the old house. The climb up the rocky path under the afternoon sun was swift and within an hour you had passed through the outer gates of this once great house. The dust and cobwebs hadn't bothered you as you climbed the old stairs to the top level. Did you notice how low the sun had fallen before the sounds of locks clicking reached your startled ears? How can the moon be out already and what's that moving towards you??? This all action game will have you ducking and diving from the GHOSTS and ZOMBIES, and matching wits with a MUMMY, WEREWOLF, and VAMPIRE. 5 floors full of odd CORRIDORS, BROKEN FLOORBOARDS, and riddled with SECRET PASSAGES await you. Superb sound effects and graphics. Can be played using either keyboard or joysticks. Top table. Pause option.

EARLY YEARS (B)(E) For children between 3-6 years of age. These two packages give an adult or older child a means to take a younger child through a series of simple game type tasks to enforce ideas. The emphasis is on learning through fun. Topics covered include subtraction, addition, recognition, colour, shapes, sizes, sounds/notes, co-ordination, distances, estimates, directions.

EARLY YEARS 1
A) MICKEY THE MONKEY and his apple tree make subtraction fun.
B) COLOUR BLOCKS bring sizes and colour into perspective.
C) MERRY MUSIC turns the keyboard into a musical keyboard.
D) FUNNY FACES presents a line up, which one is the suspect?
E) FRED THE FROG needs co-ordinated help to get across the pond.

EARLY YEARS 2
A) THE POND seems very active today
B) SPEED is required to keep the cake on the conveyor belt.
C) DIRECTIONS seem to be needed by everyone in Orion village.
D) ORDER the blocks.
E) SID THE SPIDER needs some help to get out of the maze.

Watch out for HOUSE OF HORRORS at local dealers.

Dealer enquiries welcome.

All prices are FULLY inclusive for UK orders. Please add £1 per tape for non-UK addresses. Cheques/P.O.'s should be made payable to

KAY-ESS Computer Products.

When ordering please state BBC or Electron.

Available for:
(E) Electron (B) BBC Model B
FREE with all orders (Except H.O.H.)
our 3 level version of
NOUGHTS AND CROSSES!!!

ALSO AVAILABLE:

STAR HAWKS (B) (E) - DESIGN (B) (E)
- HANGMAN (B) (E) - SPACE TRAFFIC
CONTROLLER (B) (E) - HORSES (B) (E)
- SPACE TANK (B)

KAY-ESS Computer Products,
11 Buttercup Close,
Romleighs Park,
Harold Wood,
Essex RM3 0XF.



COMPUTING

SPECIAL PRICES FOR SEPTEMBER

	<i>Price Ex-VAT</i>
<u>DISK DRIVES</u>	
3" Mini Floppy 100K Disk Drive (Cased with Leads and Utilities Disk)	£130.00
5 1/4" TEC 100K Disc Drive	£130.00
<u>PRINTER</u>	
NEC 8023 80 Dot Matrix Printer	£250.00
<u>MICROCOMPUTER</u>	
Acorn Electron	£173.04
<u>MONITOR</u>	
DECCA 1231 Colour Monitor	£190.00

GSL's Product Range Includes:

Winchester Hard Disk System · Cartridge Drives for backup · 64K
Printer Buffer · Low Speed Logic Analyser · Real Time Calender
Clock · Analogue Signal Analyser · Alternative Keyboard Display
Rack Mounting System

I would like to order:
(Please tick)



- 3" 100K DISK DRIVE
- 5 1/4" 100K DISC DRIVE
- NEC PRINTER
- ACORN ELECTRON
- DECCA MONITOR
- Send me information on your product range

(Cheques made payable to G.S.C.L.)

Or Phone LEA WYATT ON ANDOVER (0264) 59633

NAME _____

COMPANY _____

ADDRESS _____

Tel: No. _____

Return to:
LEA WYATT GSCL
WEST PORTWAY, ANDOVER,
HANTS SP10 3SG

MORE and more BBC Micro owners are accessing Prestel, British Telecom's vast database. It's not surprising, for with its Mode 7 screen, the BBC machine is ideal for receiving Prestel via an appropriate 1200/75 baud modem. Here, STEVE GOLD takes a look at how Prestel has developed, and what it's got to offer the BBC Micro.

MOST teletext systems are a trade-off between speed of access and number of pages. The number of pages broadcast via British teletext – Ceefax and Oracle – is around 600, with about 10 per cent of Ceefax pages allocated to tele-software.

Prestel, or viewdata as it is generally called, started life in the research laboratories of the then Post Office at Martlesham Heath in Suffolk.

In the late '60s and early '70s the department was examining the possibilities of developing viewphone, a service which would enable two people to see as well as talk to each other.

This scheme was eventually shelved as uneconomic, but the seed of viewdata was sown.

In 1974 the Post Office developed a viewdata system and showed it to TV manufacturers. The response was favourable and in 1975 the first steps were taken in producing viewdata televisions.

The Post Office viewdata pilot trial opened in 1976 for research purposes and two years later was extended to 1,500 subscribers in London, Birmingham and Norwich under the name of Prestel.

It soon became obvious that the £400 premium on the price of a Prestel TV set was too high for the residential user. This, coupled with high access charges, severely restricted market penetration.

The system limped along with 10,000 to 15,000 users until the light dawned on firms that here was a tailor-made business medium.

So Prestel Citiservice and Skytrack were born and business take-up blossomed. The emphasis was now on business users, and the poor old home users were neglected. Until, that is, someone hit upon the idea of converting micros to work with Prestel.

Prestel continued to blossom and in 1982, Birmingham-based Viewfax brought out a database – a group of pages – aimed at micro users and that means mainly BBC users.

Viewfax offered them a mixture of news and views, together with a number of telesoftware programs. Several were free, but the better ones were chargeable

by frame charges added to the Prestel bill each quarter.

Viewfax's main problem was the quandry most information providers find themselves in. If they charge for their frames, the number of frame accesses – the number of times viewers key in to the pages – is low. If they make the pages free, many people access the frames but there is no income for the information providers.

In practice Viewfax has developed into an interesting database with several hundred pages to look at. However, as in most businesses it cannot afford to put out too many pages or the £5 a page a year rental it pays to Prestel will cause financial headaches.

So with information providers one

apart from a local telephone call most residential users need pay little more than the £5 a quarter Prestel subscription if they stick to cheap rate, off peak times.

Micronet subscriptions are an extra £8 a quarter, resulting in a combined quarterly bill for Prestel and Micronet of £13 – just £1 a week.

For this the average micro user gets 100 free programs (if one excludes the telephone charges) and 40,000 pages of news, views and telesoftware. Plus, of course, access to the full Prestel database – some 250,000 pages.

The opportunity offered to software producers to place chargeable telesoftware on the Micronet database has not been missed. Big sellers are

For just £1 a week you can get an awful lot out of Prestel and Micronet 800

tends to find a chicken and egg syndrome. More pages are needed to generate more income, but those pages cost – so slow growth is the norm.

Viewfax, however, continues to provide a steady stream of information to BBC Micro users.

Late in 1982 East Midlands Allied Press, publishers of several regional newspapers, hit upon the idea of charging Prestel users a subscription rather than lots of small frame charges of pennies and ha'pennies.

In 1983 they launched a new service – Micronet 800 – aimed squarely at micro users. Cost? The basic subscription to Prestel is £5 a quarter, and the access charge is 5p a minute is used between 8am and 6pm Monday to Friday, or between 8am and 1pm on Saturday. Outside these hours there is no access charge. So it can be seen that

available for downloading at around 80 per cent of their retail price, which, when taken in with the convenience factor – no trip to the micro shops – is very good value.

The availability of telesoftware is, in fact, its greatest attraction. A program which may not warrant the full retail price of, say £8 could be available on Micronet or Viewfax for £2. With no distribution costs, the break even point to the author is very low.

The nearest analogy to Micronet 800 is that of an electronic computer magazine – constantly changing with up to the minute news and information.

It is possible to get by with just the basic Prestel subscription of £5 a quarter, but most BBC users will find the extra £8 a quarter well worth it.

● *Next month I shall look at the availability of other databases.*

Microweb... the most exciting thing to happen to the Beeb for yonks

OVER the past few months thousands of *Micro User* readers have logged on to Microweb and discovered for themselves why it's the most exciting thing to happen to BBC Micros for a long time.

However, trying to convey this excitement to someone who's never logged on is always difficult.

It's rather like trying to explain an adventure game to someone who's never played it... as the actress said to the bishop.

What I'm trying to do in this article is explain the adventure of Microweb to you. Not that I'll be giving you all the answers - what good is that sort of adventure?

No, I'll be attempting to give you

enough insight into Microweb to make your own journey from then on. Where you go, and what you find, will be entirely up to you...

First of all, let's get the mundane essentials out of the way with a talk about equipment. You must use a 300 baud full duplex modem with 8 bit no parity - this, I'm afraid, means that Prestel/Micronet only modems are of no use.

And of course, you'll need some suitable software - we've published the sort of thing you'll need several times. However, here at *The Micro User*, we make no secret of the fact that we think Commstar is the best for this purpose.

Let's assume that you've dialled our

number (061-456 4157) and have your modem set to 300 baud full duplex, with you set to receive.

Your modem, while of course attached to your micro and the phone line, should not as yet have "modem connect" set.

Wait until Microweb has answered your call and you can hear the high pitched whine of the carrier before you connect.

If you have Commstar running, all you need do then is to go into chat mode with "C". If it's your own home-brewed software, remember not to echo characters, add line feeds (if only at first) and make sure you're on 300/300 baud.

You should be greeted with the:

WELCOME
TO
MICROWEB

message, followed by a bit of "advertising".

At this point, should you be met by garbage, don't give up. Try the next stage to solidify communications.

Microweb will ask you your first name, expecting your answer to be followed by a Return.

It will then quiz you for your second name and, finally, where you come from.

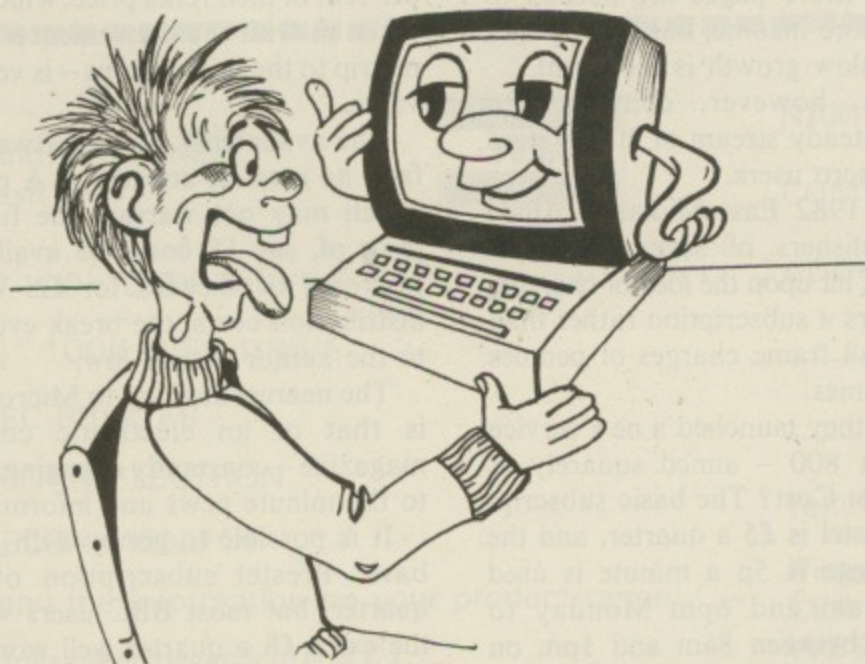

Microweb will ask you for your first name

MICROWEB Top Level Menu

```
=====
<R>ead . . . . . Microweb messages
<Q>uick-scan . . . . . Microweb messages
<L>eave . . . . . Microweb messages
<M>ail . . . . . Electronic mail section
<T>ime . . . . . Elapsed time
<P>roblem . . . . . Page
<G>oodbye . . . . . Terminate session
<D>ownload . . . . . Programs
<F>ormat . . . . . Reconfigure terminal
<X>pert . . . . . Change user level
<C>hat . . . . . Talk to Sysop
<N>ews . . . . . Latest happenings
```

Microweb's Top Level Menu

Even if you're unsure as to what's coming back to you, try to type this in correctly as it will become your unique ID.

The board will then echo it back to you for confirmation. If you answer no, you will be asked to repeat the process.

It's at this point that the board magically becomes clear for users who've previously had a lot of distortion – so persevere!

Next you'll be asked your terminal width – most of us would pick 40 – and then you'll be asked to enter the letter of your terminal.

As it stands at the moment it's rather a "choose one from one" situation – there's only one terminal to pick, the BBC Micro. This assumes that your micro can support both upper and lower case and needs no line feeds – that is, your software provides them.

However you can change this by either pressing Return when asked to pick the letter of your terminal, or by asking to modify your choice when you have made it.

In either case, you'll be asked again the width of your terminal, whether it supports upper and lower case, and if line feeds are needed. If everything appears on just one line, you need line feeds!

You'll also be asked if any nulls are needed in after each <cr> (Return). Your answer should always be 0. Nulls were padding/timing characters needed in the old, slow teletype days in order for the terminal to catch up with itself.

If you're asked for the clear screen

code, it should be just 12 for the BBC Micro – other parameters asked for should be 0.

All this sounds incredibly longwinded

By MIKE BIBBY

for something that, in practice, takes just a few seconds.

You'll then be informed what the last message on your last call was, what the current last message is and the time you're allowed on – a strictly rationed 12 minutes.

You'll then see the Microweb Top Level Menu – a set of single key instructions that will allow you to roam at will through Microweb. (See the screen above.) Before looking at the menu in detail, let's consider the general idea of Microweb.

This is simply an electronic bulletin board – ring in and leave your message for others who ring in to see. They reply to yours, or add their own subjects and so on.

And this, basically, is all Microweb is.

However, very soon, as with any bulletin board system, certain obvious categories of messages begin to occur that properly deserve their own board.

What we've done in Microweb is to provide the boards we feel necessary.

If you feel like letting off steam on a particular subject, or passing on a message to all and sundry, why not leave it on Microweb itself by choosing the <L> option from the menu?

You'll then be prompted carefully

through the easily-learned procedure for leaving messages.

If however, you've got a programming query, don't leave it here. Choose <P> from the main menu and put it on Problem Page. That's where our problem-hungry experts look as soon as they log on.

If you fancy a look at the latest news and gossip, with unexpurgated Barry Woods and messages smuggled over the wire from Andrea, pick <N> from the main menu.

You might, of course, be using us as a dead letter drop to send messages privately to a particular person. In this case, choose <M> for electronic mail (E-Mail). Only people who log on as the intended recipient will see the message.

Incidentally, one of the commonest misuses of the board is people using the essentially private E-mail to send messages to ALL.

This will only send the message to the rather unlikely person who logs on as ALL.

If you wish your message to be read by all, including ALL, leave it on Microweb proper with <L> from the main menu.

Well, as you can see from the Top Level menu, we're only on the surface of the possibilities of Microweb. For example, we've totally ignored the software you can download.

In the next edition of *Log On*, I'll tell you more, but for the moment, why not log on and find out for yourself? After all, it's not an adventure if I tell you everything . . .

NEWS!!!

From: Basildon Itec

To: All

Basildon Itec has just joined the 300 baud mob. We are thinking of setting up our own BB for our trainees to run. Any advice welcome. We have VIEWDATA host running on 0268 - 22177 unless the line being used by this system. More modems soon. Thanks.

From: Mike Bibby

To: All

We're still very very interested in getting submissions of games and educational programs - particularly in the educational field as that's where I hail from and I know there's an awful lot going on that's terribly parochial.

The material we've got already is very exciting. One of the things that amazes us here is that the level of software we get for the magazine tends to exceed that of commercial software produced only a few months before.

There are an awful lot of sophisticated programmers out there! We're also interested in new utilities - have you anything to contribute? Even if you aren't sure, why not send us a SAE for our programmers' and reviewers' guidelines? Mike.

From: Paul Hollyer

To: All

Mr and Mrs Hollyer are pleased to announce their new acquisition. Delivered as at 10.45am on Sunday July 15, in Chesterfield. Only five days beyond advised delivery time (Sir Clive please note). An example of interfacing at its best. A micro weighing in at 8lb 4oz.

Originally designated the Model 2. Now universally addressed as "Robert James". Needs some further development, with complete programming, but hopefully will grow to a "main-frame".

P.S.: Many thanks to all at the Scarsdale Hospital, Chesterfield!

From: Bjarne Listlund

To: All

To all users on this databank. I hope we can make a user group for microbee owners we don't see one here in Denmark. I hope there are some users on this micro. Users there will please help me.

You can contact me on phone number 05 928959. If you will contact me on my modem you have to call after 1900 then I will answer you. Or you can write me on address: Bjersegade 69 7000, Fredericia DK-7000, Fredericia.

IN GENERAL!!!

From: Tim Crais

To: All

A joke.

Q. How can you tell that an Irishman has been at the word processor?

A. The Tippex on the screen.

From: Paul Hollyer

To: Sysop

Many thanks for allowing a member to wander at will, as the Board is so easy to use. Only query is - What is the difference between "<L>line and lock entry" mode? Also, why do my sentences get split up with "(1916)"?

From: Mike Bibby

To: Paul Hollyer

Line and block with prompts are much the same, you just type them in as normal. Ignore breaks, they don't show up on the message. It's just a simple way to write the software and the only way they could do it in the size of program they've got available - otherwise they'd be writing a full RS232 word processor. The numbers refer to the numbers of bytes left your allowed for this message.

The real advantage of block is that you can then transmit a whole file - say from disc - in one fell swoop - or block - and the board would accept it. Hope that's clear. Mike.

PROBLEM PAGE ...

From: Paul Hollyer
To: All

I've just got the second processor and I find that some of the ROM based *commands I have either don't work or operate in a restricted manner. An example are the commands with the Graphics Extension ROM. These work with the system integer A% normally, but with the second processor they fail, operating properly with numbers. HELP!!!

From: Des Riglar
To: Paul Hollyer

When running Basic the system variables (A%,B% etc) are stored from location &404 onwards. Each variable takes up 4 bytes of memory. When running in the main processor the sideways ROMs can access this memory, but when running in the second processor the ROMs can't unless they are programmed to do so. All is not lost though, as when the operating system processes a star command (*ROTATE, *PLOT, *SCALE etc) the whole command line is piped to the main processor. Solution: Convert all commands to be performed into strings and use OSCLI. Example: Page 40 of User Manual, line 50 in main processor *POS J%,I%,90. To use in the second processor ... OSCLI"POS"+STR\$(J%)+","+STR\$(I%)+",90"
Don't forget to put the spaces between the arguments. If you want to use the *GFX command then to get A% as seen in the main processor you will have to use OSWORD 5 to read from &404 and the next 3 bytes. This applies to B% & E% as well.

From: Richard Atkinson
To: Doug Weller

Hi Doug. On reading one of your letters about downloading with Commstar I followed it but when I tried to load it from disc "Bad Program" was the answer I received. Can you give me any HELP!

From : Doug Weller
To: Richard Atkinson

Most programs downloaded from BBs are in Ascii form (except for a couple on Computer Answers). This means that you have to *EXEC them first and then SAVE them as Basic programs. So you've got them OK just *EXEC them and SAVE again.

From: Mark Austen
To: All

Can anyone tell me the pin-out of the RS232 port on the Interface 1 for the Spectrum?

From: Dick Menhinick
To: Mark Austen

Hi - The ZX Interface 1 has the following pinouts: 1, No connection; 2, data input; 3, data output; 4, DTR (active handshake input); 5, CTS (active handshake output); 6, no connection; 7, ground; 8, no connection; 9 +9V (pull up). The connector on the interface is a DB9S (female) as you will need a DB9P to connect to it. Happy soldering.

THESE are typical messages that have appeared recently on Microweb - The Micro User's own bulletin board. All you need to log-on to us is a modem and suitable software. The Pace combination is ideal and, as you can see from the offer on Page 170, superb value for money.

As well as the bulletin board, there are news pages, programs to be downloaded and electronic mail. Log-on soon, and you'll see why they're saying Microweb's a must for every BBC Micro User.

**The number to dial:
061-456 4157
The service is open
24 hours a day.**

ANDY HOOD offers a short program to enable you to join the bulletin board set

IN my article in the July edition of *Log-on*, we looked at the easy way in which flows of data in the BBC could be directed at any or all of the three main output devices — screen, printer and RS423 port.

We also covered the equally easy manner in which data could be received from combinations of the keyboard, filing system and RS423.

In following through the concept of streaming data to and from different devices, and — in our application — creating a program to store data received at the RS423, we touched upon the concept of “buffering” data in memory until it was convenient to interrupt the program and process it by saving it onto tape or disc.

In doing this we mimicked, in a simple way, one of the most powerful features of modern micros.

You may have noticed when typing at the keyboard that even when the micro appears to be busy listing a program it still finds time to acknowledge your key press and, when it has finished its main task, display and act upon your input.

To do this, the micro must obviously be regularly interrupting the action of listing the program, checking to see if any keys have been pressed and if so, putting them into a temporary store or buffer.

This kind of almost invisible background task is occurring all the time and for obvious reasons is known as an interrupt routine. Frightening isn't it, what's going on behind your back!

The Beeb has one of the most comprehensive sets of interrupt routines of any modern micro and the majority of its input and output is buffered, in a similar way to the keyboard example, by these secretive routines.

The automatic storage and release of data collected in these various internal buffers means that short bursts of data can be sent or received at quite phenomenal speeds.

These can then be processed at a much slower rate, provided that the buffer is emptied before the next batch of data is received.

You may by this time be wondering why I am going into such detail about a routine that is carried out entirely automatically by the operating system and which on the face of it needn't concern us. The answer of course is that it does.

I mentioned last time we would be looking at the protocols or “etiquette”

used in communications to ensure that both the sender and receiver of data are, as you might say, in “sync” with each other.

The most common of these protocols is the use by a receiving terminal of decimal codes 17 and 19 to tell a sending terminal when to stop and start data transmission. These are known by the mnemonics XON (17) and XOFF (19).

Simply put, they work something like this:

When a sending terminal receives the XOFF signal during the transmission of data, it should immediately cease sending characters until it receives the XON signal to instruct it to resume transmission.

Simple, you say, and so did I the first time I tried it. But this is where those interrupt routines beaver away in the background can cause problems.

You will probably be familiar with the term *baud* used as a measure of the speed of data transfer — 300 baud being roughly equivalent to 30 characters per second.

Imagine then our super fast machine code program — yes there's more to come — executing on average half a million instructions per second, placing characters in the RS423 output buffer which is only being emptied at the rate of 30 characters per second.

You can readily see that the program is going to spend nearly all its time waiting for the RS423 buffer to be emptied, and that at any point when we

A micro terminal for the asking..

receive an instruction to stop placing characters in the buffer the interrupt routine will still have a full buffer to empty, which of course it will carry on doing after we have stopped.

Should this happen, we will still be sending characters to the remote terminal after the XOFF signal has told us that it is not ready to receive them.

Perhaps the obvious answer is to stop those interrupt routines from operating and indeed the 6502 processor does have a specific flag to either disable or enable them under user control.

This is known as the “I” flag and responds to the assembler instructions CLI — CLear Interrupt enable (that is, disable them) and SEI — SEt Interrupt enable.

However, using this method has two major drawbacks. More importantly the interrupt enable flag is not to be lightly tampered with on such a heavily interrupt driven machine as the Beeb (dabble at your peril!).

In addition, we would lose all the advantage of automatic data collection that the interrupt routines provide for us. Fortunately, and not surprisingly, the MOS again provides us with a routine to solve our problem in a more satisfactory way.

Much as the FX or OSBYTE call 145 that we looked at in the last article extracted characters from buffers and returned with a flag set to indicate whether it was successful or not, OSBYTE call 152 will check the appropriate input or output buffer and

Interrupts, beavering away in the background, can cause problems . . .

return with a flag set to indicate whether the buffer is empty or not.

The important difference is that it does not extract any data from the buffer, but merely checks its current status. If the buffer contains characters then the carry flag will be clear on exit and if empty it will be set.

We may then place a character into the output stream and repeatedly scan the buffer until the OSBYTE routine indicates that it is empty, ensuring that a queue does not form in the buffer waiting to be cleared by the interrupt routines.

In my previous article, I said that we would look at coding more of our terminal program in assembly language to increase its speed and flexibility.

The Micro Term program shown in Listing I is written entirely in machine code and as well as incorporating the XON/XOFF protocols for file transmission, it will allow you to copy incoming data to the memory buffer, save the buffer contents to, or load the buffer from, disc or tape and send the buffer contents to the RS423 port.

To assemble the program, first type

PAGE=&3000 and then load the source code listing. Run the program and when the assembly is complete enter:

```
*SAVE MTERM 1A00 1D00 1A00
```

The program may then be run from disc or tape by entering *MTERM.

The following function keys are used to control the program's actions:

- f0 Copy incoming data to the buffer. This is a "toggle" switch and will alternately switch the buffer on and off with appropriate status displays.
- f1 Output the buffer to the RS423 port. This will send the entire buffer contents using XON/XOFF protocols.
- f2 Save the buffer to disc or tape. Pressing this key will clear the screen and prompt you to enter a valid filename. The entire contents of the buffer are then transferred to

a file which, if a Basic program, may be re-entered into the computer using the *EXEC file-spec command.

- f3 Load a file into the buffer for transmission using the f1 option. A filename prompt is given in a similar manner to the save option.

This short program will enable you to communicate with many bulletin boards, and of course with *The Micro User's* own Microweb system, and will allow you to both upload - send - and download - receive - both messages and programs.

The program is an example of how easy the BBC Micro with its powerful operating system can make machine code programming.

In the next article, we will look at how those curious assembler instructions work.

Happy hacking!

Micro Term listing

10 REM Listing	tus=&78	t1	yboard	740 BCC wait
I	180 start%=&1A00	370 STA buffpoin	530 JSR storecha	750 RTS
20 REM Micro Te	190 FOR opt%=0 T	t1	r	760 .sendchar
ra	0 3 STEP 3	380 STA bufftop1	540 .check_keybo	770 PHA
30 REM <C> Andy	200 P%=start%	390 STA xon_xoff	ard	780 JSR toRS423
Hood 1984	210 [OPT opt%	_status	550 JSR keyboard	790 JSR wait
40 OSASCII=&FFE3	220 .entry	400 STA buffer_f	_scan	800 PLA
50 OSWRCH=&FFEE	230 \REM enable	lag	560 BCS mainloop	810 JSR OSWRCH
60 OSBYTE=&FFF4	RS423 input	410 LDA #&1D	570 JSR sendchar	820 RTS
70 OSFILE=&FFDD	240 LDA #2	420 STA buffstar	580 JMP mainloop	830 .increment_s
80 OSWORD=&FFF1	250 LDX #2	th	590 .getchar	ore
90 buffstartl=&	260 JSR OSBYTE	430 STA buffpoin	600 LDA #145	840 INC bufftop1
70	270 \REM set up	th	610 LDX #1	850 BNE nocarry1
100 buffstarth=&	transmit 300 ,rece	440 STA bufftoph	620 LDY #0	860 INC bufftoph
71	ive 300	450 \REM program	630 JSR OSBYTE	870 .nocarry1
110 bufftop1=&72	280 LDA #7	loop	640 BCS nochar	880 RTS
120 bufftoph=&73	290 LDX #3	460 \REM *****	650 TYA	890 .increment_p
130 buffpointl=&	300 JSR OSBYTE	470 .mainloop	660 RTS	ointer
74	310 LDA #8	480 JSR getchar	670.nochar	900 INC buffpointl
140 buffpointh=&	320 LDX #3	490 BCS check_ke	680 RTS	910 BNE nocarry2
75	330 JSR OSBYTE	yboard	690 .wait	920 INC buffpoin
150 buffer_flag=	340 \REM set up	500 JSR display	700 LDA #152	th
&77	buffer & flags	510 LDX buffer_f	710 LDX #2	930 .nocarry2
160 operand=&76	350 LDA #0	lag	720 LDY #0	
170 xon_xoff_sta	360 STA buffstar	520 BEQ check_ke	730 JSR OSBYTE	

Turn to Page 171

APPLICATIONS for the BBC Micro in communications mode are unlimited, but here are a few suggestions:

● Use a BBC word processor, such as Wordwise or View, at home or in the office to prepare text, and then copy the whole lot over to a professional word processor for quality printing after some reformatting to take advantage of the expensive daisywheel's characteristics.

● Use the BBC Micro in the laboratory to collect data off apparatus, over a period of hours or days perhaps. After suitable processing with a BBC program, copy the files generated to the mainframe, where high-powered programs can lick the data into shape, or store it on the mainframe's very large filing system.

● Use the mainframe to extract data from its files, in a suitable Ascii format, and move that data to the BBC Micro, where it can be displayed, manipulated, reformatted and generally digested, before sending it back to the mainframe.

This application might be appreciated in busy installations where the mainframe is heavily loaded with many different users.

● Build up lots of separate data files on many different BBC Micros before sending it all to the mainframe for storage on a database, which could then be examined by the people who provided the data.

This is a way in which a large organisation, maybe a charity or political party, can get its data computerised by voluntary help without clogging up the central office with tens of thousands of records which would overwhelm limited resources.

Have YOU any suggestions for linking the BBC Micro to a mainframe? If you have any ideas to share with our readers – especially if they have actually been put into practice – send them in.

We will pay £10 for every idea published – and more for detailed descriptions.

The address to write to is:
"Mainframe",
Europa House,
68 Chester Road,
Hazel Grove,
Stockport SK7 5NY.

Talking to big brother

By JOHN LEACH

ONE of the most valuable applications of the BBC Micro is to make use of its power to communicate with large computers.

It brings to life the concept of distributed processing, where small jobs are done by the micro, but for big jobs, or to read very large files, it links in with the mainframe.

This application may not sound very exciting to the lone home enthusiast, or even a school. But you only have to walk around any university computing department, or one of the many firms with mainframes, to see the BBC Micro used in this way.

How do you communicate with a large computer?

The simple answer is that you connect three wires to the RS423 port and connect these to the mainframe input/output port.

That really is a bit too simple because the vital software element has been omitted.

Lots of articles have appeared during the last couple of years on communication between computers, with associated programs, but very few go far enough to make a particularly valuable contribution to the problem.

Before going on, let's define a few terms.

Mainframe: Any large (greater than 1 megabyte), multiuser, multitasking computer which supports interactive terminals. There is a very blurred distinction these days between a minicomputer and a mainframe, so let's

not muddy the issue by considering this argument.

For our purposes the mainframe must be capable of sending asynchronous RS232 protocol Ascii to and from its terminals, and it must use the XON/XOFF protocol, of which more later.

Terminal emulation: First of all, the BBC Micro must be able to emulate the terminals supported by the mainframe. Usually these will be complex devices with cursor control, highlighted characters, graphics of various kinds and different scrolling modes.

There are many different types of terminal, and each will have its own set of control codes, usually in the form of an Escape sequence – that is Ascii 27 – followed by a mode definition byte, followed by a varying number of bytes according to the specified mode.

Anyone who has programmed graphics on an Epson or similar printer will be familiar with Escape sequences.

One of the most popular terminals for mainframes is the DEC VT100 and its offspring. The BBC Micro is quite capable of emulating nearly all the VT100 features, apart from the 132 character per line screen mode.

Another terminal family widely used in industry is the Tektronix graphics terminal, which can be used for graph plotting and picture drawing in general.

File transfer: While it is very nice to have the BBC Micro used as a cheap but effective spare terminal, this hardly counts as distributed processing.

The vital extra feature is the ability to

transfer files to and from the mainframe, and this is where the problems begin in trying to write suitable software.

Assuming that a disc system is attached to the BBC Micro, the software must ensure that every byte sent by either machine is copied over correctly, and at the same time the

process must be stoppable by keyboard interference.

Errors can occur during transmission. The mainframe may for some reason stop sending data for a while, the BBC may develop a disc fault - Disc Full, perhaps - or you may decide that the wrong file is being transmitted

anyway and want to halt the process.

During file transfer it is essential that the XON/XOFF protocol is properly observed by the BBC software. This protocol enables two computers to

Don't feed the mainframe garbage

HERE are two short programs to enable your BBC Micro to communicate with a mainframe.

Remember that it is no good writing data to disc file in the normal way with programs like:

```
100 file=OPENOUT("DATAFILE")
```

```
.....
```

```
200 PRINT#file,VARI,Z%,TEXT$
```

```
.....
```

```
300 CLOSE#file
```

The BBC stores data in a special coded form, such as with strings saved backwards on disc. To see what is going on, just *DUMP a file written in the conventional Basic way.

If such a file is sent to a mainframe it would read garbage. The mainframe requires a pure Ascii file, with text the right way round, and each line of text terminated with a carriage return (&OD).

Fortunately the operating system contains a little known feature which can come to the aid of the hard-pressed programmer.

Ever heard of *FX3,16? Neither had I until I read the Advanced User Guide. This nice feature turns off the spooler.

As everyone knows, a file created with *SPOOL sends all screen/printer output to the named file, including screen prompts and so forth.

Using *FX3,16 you can select just what output you want to go to the disc file, as the following program illustrates:

```
10 REM Creation of an ASCII file
   from a BASIC program
```

```
20
```

```
30 REM J.M. Leach, 1984
```

```
40
```

```
50 DIM COMMAND 40
```

```
60
```

```
70 MODE 7
```

```
80 PRINT ""
90 INPUT "Enter output file name
   > "F$
100 PROCoscli("SPOOL "+F$)
110 PROCset_spool(FALSE)
120 REM Demo program saves even
   numbers only on file
130
140 FOR I%=1 TO 20
150 IF I% MOD 2=0 OUT%=TRUE
   :Q$="Even"
   :
   : ELSE OUT%=FALSE
   :Q$="Odd "
160 PROCset_spool(OUT%)
   : REM Write if even
170 PRINT I%;" ";Q$
180 PROCset_spool(FALSE)
   : REM Turn off spooler uncond
   itionally
190 NEXT
200 PROCoscli("SPOOL ")
210 REM Demonstrate output file
220 PRINT "Press <RETURN> to see
   file ";F$
230 REPEAT UNTIL GET =13
240 CLS
250 PRINT ""
260 PROCoscli("TYPE "+F$)
270 END
280
290 DEF PROCoscli(text$)
300 $COMMAND=text$
310 X%=COMMAND MOD 256
320 Y%=COMMAND DIV 256
330 CALL &FFF7
340 ENDPROC
350
360 DEF PROCset_spool(logic%)
370 IF logic%=TRUE PROCoscli(
   "FX3,0")
   ELSE PROCoscli("FX3,16")
380 ENDPROC
```

The procedure PROCoscli is provided for those without Basic II. If you have this use the OSCLI command and remove line 50.

The output file could be copied straight to a mainframe and then, preferably, deleted after display.

We now know how to write an Ascii file to disc, ready for transfer to a mainframe.

What about reading the file back in again? Unfortunately BBC Basic has no facility for reading such a file from disc, as it expects the special coded form referred to previously.

However it is quite easy to write a simple routine in Basic or machine code to read such a file and build it into a string, which can be decoded with MIDS, VAL, and so on.

Here is a very short Basic version, which will read a file created by the previous program. In practice, of course, the file would have been copied over from the mainframe:

```
10 REM Function returning string
   from ASCII file
```

```
20
```

```
30 REM J.M. Leach, 1984
```

```
40 MODE 7
```

```
:PRINT ""
```

```
50 INPUT "Enter file name to be
   read > "F$
```

```
60 PRINT
```

```
70 F=OPENUP (F$)
```

```
80 REPEAT
```

```
90 line$=FNread
   :PRINT line$
```

```
100 UNTIL EOF #F
```

```
110 CLOSE #F
```

```
120 END
```

```
130
```

```
140 DEF FNread
```

```
150 LOCAL A$
```

```
160 REPEAT
```

```
170 Q%=BGET #F
```

```
180 IF Q%>=32 AND Q%<=127 A$=A$+
   CHR$ (Q%)
```

```
190 UNTIL Q%=13
```

```
200 =A$
```

From Page 119

communicate over three wires – data in, data out and ground.

On the BBC Micro the RS423 port also contains the RTS and CTS handshaking lines, which are used when, for example, a serial printer is connected.

If these pins were used in communicating with a mainframe five wires instead of three would be needed, and it would not be possible to make use of a modem.

Connecting the BBC Micro is easy enough, provided one vital thing is done – connect the RTS and CTS pins together inside the DIN plug inserted into the BBC Micro.

If this is not done the whole project will fail and the micro will just hang up.

XOFF means that an Ascii 19 Ctrl S character is sent, which tells the other computer to halt transmission until XON Ascii 17 Ctrl Q is received.

This is essentially a two way process, for typing Ctrl S at the BBC keyboard must make the mainframe stop sending data temporarily, until re-enabled with

Ctrl Q. Conversely the mainframe, busy with perhaps dozens of other users, must be able to tell the BBC Micro to shut up for a while.

The mainframe XON/XOFF sequences will be invisible to the user, except perhaps for occasional jerkiness in the terminal display.

However the BBC Micro file system is very slow compared with mainframe systems, which can write to files at megabytes per second. So when a block is to be written locally, the mainframe must be prevented from sending any more information, as otherwise the RS423 input buffer will fill up.

From what has been said already – and that unfortunately is not the full story – the reader may be left wondering what the point of this article is, if there are so many pitfalls to be avoided.

Well the simple answer is, go and buy a chip!

As the usefulness of terminal emulation and file transfer was recognised some time ago, lots of people have achieved the objective, and there is quite a wide choice of sideways eproms available.

Computer Concepts, for example, have produced Termini, a fairly unsophisticated program, and Communicator, which emulates the VT100, but can be tailored to suit other terminal types.

Pace have produced Commstar, which additionally gives teletext displays and will link into Micronet. Several university computing departments, such as Bristol, Bath and Sussex, have written eproms.

Workstation, from the University of Sussex, is the only one with which I have had personal experience. It behaves faultlessly when connected to a Vax computer, allowing terminal emulation both as a VT52 terminal (a less sophisticated VT100), a Tektronix graphics terminal, and a disc file to mainframe two way transfer facility.

An extra goody is a screen dump to Epson printer routine, when in Tektronix mode. This works fine, if rather slowly.

In VT52 mode it supports all the DEC EDT screen editor function keys. This statement may not mean much to non-DEC users, but there are a lot of them about.



ROM/RAM Expansion Board

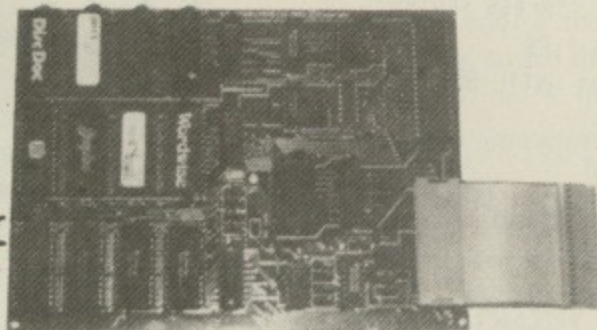

£54.95

THE ULTIMATE ROM/RAM EXPANSION SYSTEM FOR THE BBC MICRO

- ★ 12 extra ROM sockets complement those already provided by the micro to allow up to 256K ROM space.
- ★ Four of these sockets can support either ROM or Static RAM (up to 16K maximum RAM).
- ★ The Model 2 board allows switching between multiples of 2K, 4K, 8K or 16K ROM/RAM.
- ★ Compatible with most other add-ons including TORCH, 2nd processors.
- ★ Additional features include the ability to transfer paged firmware to disc, and then load back into sideways RAM for future use – giving you no limit to the number of effective ROMs accessible!
- ★ NO soldering, plug-in design.
- ★ Fits easily inside BBC case.
- ★ Plugs into CPU socket via short flexible connector.
- ★ Improved plug design allows the Model 2 board to connect securely to any type of BBC CPU socket with no harm to micro or board.
- ★ Board is held in place by sturdy supports.
- ★ Full instructions provided.

All our prices are inclusive of VAT unless specified otherwise. **Postage & Packaging:** Please add £1 for small items (ROM/RAM Boards, Software, etc), £2.50 for medium items (Disc drives, BBC Computers), £10 for heavy items (Printers, monitors, etc). (Postal rates apply within UK only. Please telephone for export rates) Access/Barclaycard Telephone orders welcome

SIR COMPUTERS LTD

91 Whitchurch Road, Cardiff CF4 3JP.
Tel: Cardiff (0222) 621813

SIR BUSINESS & COMMUNICATIONS

We announce our appointment as TORCH UNICORN Dealers, at a time when Acorn & TORCH are joining forces . . .

THE TORCH UNICORN RANGE:

CP/M compatible extensions to the BBC Microcomputer System:

ZEP 100: Z80 2nd processor card; 64K RAM; FREE SOFTWARE (see below) £299 + VAT.
ZDP 240: Z80 Disc Pack comprising ZEP 100; 2x400K floppy disc drive; FREE SOFTWARE (see below) £799.00 inc. VAT.

HDP 240: As ZDP 240 but with one 400K drive replaced by a 20MB Winchester Hard Disc unit . . . around £1,995 + VAT.

HDP 68K: As HDP 240 but with twin (Z80B and 68000) "second" processors; provides an extra 256k RAM! . . . around £2,495 + VAT.

THE UNICORN: Top of the range. The TORCH UNICORN comprises HDP 68K plus FULL UNIX III Operating System . . . around £2,895 + VAT.

TORCH C-500: Complete self-contained unit (no BBC Micro required) comprising BBC Micro system, ZDP, hi-res colour monitor & British Telecom-approved communication card. **Price available on application.**

FREE SOFTWARE: BBCBASIC (Z80) [allowing almost 48K User Memory!]; 'Perfect' Writer (**word processor**); 'Perfect' Calc (**spreadsheet**); 'Perfect' Filer (**database filing system**); Complete software package normally worth about £1,000!!

BBC MICROCOMPUTER
BBC Model A £299.00
BBC Model B £399.00
BBC Model BD £469.00

DISC DRIVES
Single 100k NOW £139.00
Dual 100k NOW £279.00
Dual 400k (40/80 Track Switchable) NOW £399.00

PRINTERS
Dot Matrix:
Shinwa CP-80 £219.00
Epson RX-80 F/T £275.00
Epson FX-80 £389.00
Daisywheel:
Juki 6100 £389.00

ACORN BBC SECOND PROCESSORS
6502 2nd Processor ... £199.00

MONITORS
Sanyo B/G £85.00
Microvitec RGB £219.00

SOFTWARE
We have a range of BBC and Electron titles currently in stock including ROM based programs such as

VIEW (£59.80), New 2.1 version **Computer Concepts' GRAPHICS ROM (£32.20)**, **WORDWISE (£39.95)** and **DISC DOCTOR (£29.95)**.

Please telephone for full details of software range and current stock.

Z80 2nd Processor £299.00

A STAR IS BORN



PRESTEL, MICRONET, BBC to BBC file transfer, Terminal Emulation.

Commstar is unique and complete, a total solution. Imagine, a single Eprom-based package of sophisticated communications software that caters for all your requirements.

Imagine Commstar

Take for example British Telecom's Prestel service offering access to a multitude of up-to-the-minute information pages, world news or weather and much more. Instant access to Micronet 800 with many free programs that can be downloaded in seconds, free advice and news. Expand your horizons and find out just how versatile our computer can really be!

How many times have you wanted to get a copy of a program to a friend or a business colleague, quickly? With Commstar you can transfer a file of ANY type, between two BBC's (which may be thousands of miles apart), in the space of a phone call. It really is that simple!

Commstar is 'intelligent'. It offers many advanced features to ensure simple and effective communication with the remote system.

Consider the following features:

Prestel Mode

Prestel mode features full colour Prestel graphics including double height and flashing characters. Full Telesoftware capability is offered allowing the many free programs offered by Micronet 800 to be downloaded into your computer. Pages of particular interest may be 'marked' for later retrieval and display. Page images may be copied and saved to a file on the current filing system.

Terminal Mode

In terminal mode all input may be copied into a buffer in memory or spooled directly on to disc. Full control over buffered data is provided allowing it to be listed to screen or printer, sent to the RS423, saved to or loaded from the current filing system (including TAPE).

Commstar allows full configuration and easy control over the protocols used. Send and receive baud rates, word length, parity and number of stop bits are selected from a simple table of options.

When in chat mode (80 or 40 column), characters transmitted by the host will be displayed on the BBC screen and characters typed on the BBC will be sent to the host.

Commstar allows ANY type of file (not just ASCII) to be transferred 'safely' using XMODEM protocols. In fact, four individual methods of transmission are provided for within Commstar giving great flexibility.

Using a disk based emulation file, Commstar can be configured to emulate virtually any terminal type including VT 100, within the capabilities of the BBC.

In addition to the above, most MOS commands can be executed from within Commstar, errors are trapped by Commstar's own error-handling routines and an optional elapsed time clock may be displayed. Data filter, Local Echo, Auto-line-feed, printer on/off and XON/XOFF protocols may be toggled in or out by a single key press, extensive use being made of the function keys. Finally, Commstar may be fitted into any of the sideways ROM sockets and is provided with a comprehensive manual.

£34 inc. VAT & Carriage.



A revolutionary new approach to program development aids.

Toolstar is a powerful new utility Rom that will open up a whole new world for BBC micro users. Toolstar adopts a revolutionary new approach to program development aids. It has been designed specifically to assist both Basic and Machine code programmers by providing an integrated set of powerful building blocks which rapidly become an indispensable complement to the built in facilities of your BBC micro.

This package contains the Toolstar firmware in Eprom and a very comprehensive manual (over 150 pages), containing many examples and illustrations to help you make the best use of Toolstar's exciting capabilities.

Toolstar sheds new light on your BBC micro

Toolstar, being Eprom-based will be permanently resident in your computer allowing all of its commands to be immediately available. It is 'transparent' to both the user and the operating system; once a command has been executed, control is returned to Basic, or whichever ROM had control prior to the command.

Full error handling has been incorporated and for new users there are full help menus describing each command and its syntax.

Powerful building blocks for Basic programmers?

Within Toolstar there are 22 commands, 8 of which operate between PAGE and TOP i.e. on the current Basic program or Basic programming environment. These commands obey standard Basic command syntax rules.

Reveal the deepest secrets of your discs

Toolstar allows the operations of Formatting, Verifying, reading or writing a disc sector to be carried out very simply from Basic i.e. all the necessary building blocks required to develop a comprehensive set of disc utilities, simply and effectively.

Lost your memory? - No more amnesia with Toolstar!

In addition to the commands described above there are 9 commands which operate on the whole of the BBC's memory and are designed to complement the BBC's built-in assembler. These include a full feature disassembler and memory dump, each with forward and reverse scrolling.

If this is not enough Toolstar can be Extended!

There are three help menus on Toolstar which may be obtained by typing HELP TOOLS, *HELP MCODE or *HELP EXTEND. The third option menu will initially display the following:

*HELP EXTEND
EXTEND <RAM adds>

i.e. typing *EXTEND <address> will allow the user to extend the facilities of Toolstar with routines which are supplied by himself. The manual describes fully how this operation is carried out and illustrates it with several examples.

In the future such utilities will be made available on disc and cassette from Pace, thus allowing a comprehensive library of utility programs to be built-up.

£34.00 inc. VAT & Carriage.

Access and Barclaycard
Dealer Enquiries welcome
Send for more information to:



92, New Cross Street,
Bradford BD5 8BS.
Telephone: 0274 729306
Telex: 51564

mw systems

SUMMER SPECIAL OFFERS



ONLY
£330

MWS 800K (1.6MB) at Double Density.
DUAL DRIVES from TOSHIBA.
These drives are double sided/double density and are 40/80 Track Switchable.



ONLY
£200

MWS 400K (800K at Double Density).
SINGLE DRIVE from TOSHIBA.
These drives are also double sided/double density and are 40/80 Track Switchable.



NEW PRODUCT RELEASE

ONLY
£140

MWS 200K.
A SINGLE DRIVE from EPSON.
These drives are double sided/single density and are 40 Track.

mw systems ltd.

Matrix House
Lincoln Road
Cressex Industrial Est.
High Wycombe
Bucks
Tel (0494) 450341

ORDER FORM

All prices are exclusive of VAT.
Price includes Formatting Disc,
Manual and all Cables.
All units carry a one year warranty.
All units are ex stock.

Please supply the following Order

	Quantity	£	p
MWS 800K DUAL DRIVES Summer special offer price £330.00			
MWS 400K SINGLE DRIVE Summer special offer price £200.00			
MWS 200K SINGLE DRIVE Summer special offer price £140.00			
MWS 100K SINGLE DRIVE (not illustrated) Summer special offer price £135.00			
MWS Optional Power Supply £35.00			
Please debit my Access/Barclaycard/Amex/Diners	Delivery	£10.00	
	Sub Total		
Card No. <input type="text"/>	VAT 15%		
I enclose a cheque for £..... made payable to MW Systems	TOTAL		

Name _____

Address _____

Tel No. _____

Here's something **SPECIAL** from

BARGAIN OFFER!
FOUR classic games for only £1.50 each

THE MICRO USER

We've commissioned four rip-roaring games for the BBC Micro and Electron

Three of this high-powered collection are top-rate machine-code versions of arcade classics and the fourth is a thrilling real-time adventure game. There's hours of enjoyment and something to suit everyone in this unique value for money collection

SNAPMAN – Guide your man through the maze as he munches energy pellets and avoids hostile aliens

ALIEN INTRUDERS – With only your laser for protection you must destroy the waves of aliens who threaten to engulf you

PANZER ATTACK – You are a tank commander engaged in vicious combat against encircling enemy forces

MAYDAY – A futuristic adventure! As captain of an interstellar cruiser you must guide the sole survivor of a stricken space freighter through the wreckage of his craft. If you fail to recover those vital medical supplies a whole planet is doomed!

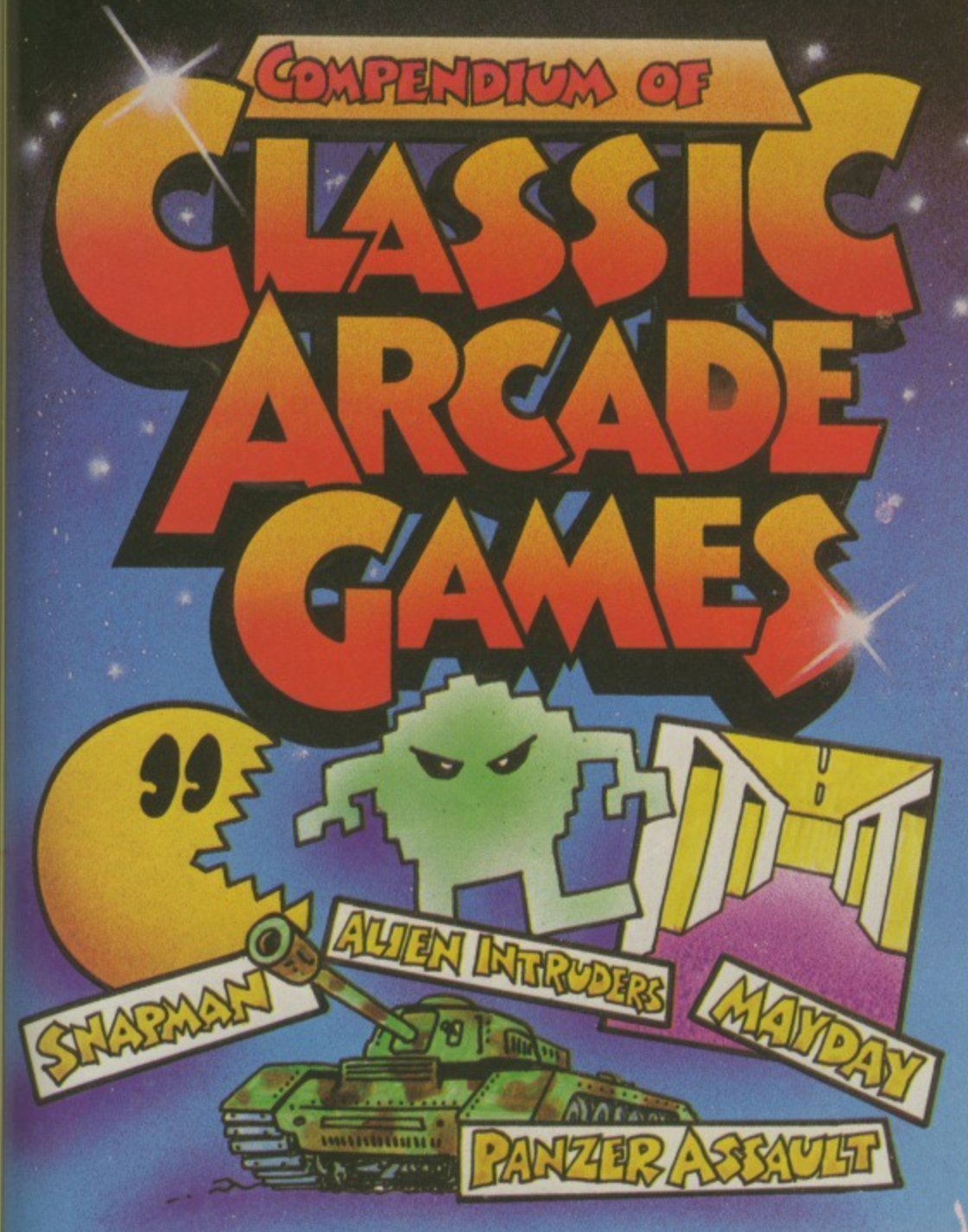

Please send _____ copy/copies of Classic Arcade Games.

I enclose cheque made payable to Database Publications for £ _____

I wish to pay by Access Visa No. _____ Expiry date _____

Name _____

Address _____

Post code _____ Tel: No. _____

- BBC Micro tape £5.95
 - BBC 40-track disc £7.95
 - BBC 80-track disc £7.95
 - Electron tape £5.95
- (Please tick)*

Post to: Classic Arcade Games offer, Micro User, 68 Chester Road, Hazel Grove, Stockport SK7 5NY

20,000K Winchester Disc for your BBC Micro

INTEC MAKES THE BBC REALLY COMPETE WITH
SYSTEMS COSTING 2X AS MUCH!



- ▶ Supports BBC and Acorn DFS.
- ▶ Full file handling and diagnostic software utilities.
- ▶ Data capacity from 5 Mb upwards.
- ▶ High speed accessing.
- ▶ UK manufactured.

The INTEC 505 gives all these benefits PLUS the removable hard disc cartridge providing a compact, secure and usable back-up or cartridge per application approach. Why pay more for less?

For full details on the INTEC range of hard discs for the BBC Micro, complete and post the tear-off slip or phone INTEC now - 01-761 5999.

INTEC
41A-45 Knights Hill
West Norwood, London SE27 0HS
Telex 8813271 GECOMS G

SEE US AT

The 2nd
Official
Acorn User
Exhibition
OLYMPIA
16-19 AUGUST
1984

INTERFACE TECHNOLOGY

INTEC

Please Cut Out and Return
The INTEC Hard Disc Range
5-20 Mb Winchester and the fixed and removable 505.

NAME _____
ADDRESS _____

BBC SEPT

Interbeeb DCP Microdevelopments

IT is true to say that no matter how many inputs and outputs you provide on a computer somebody will always want more. Fortunately there seems no shortage of those willing to provide them.

One neat idea comes from DCP Microdevelopments and is called Interbeeb. It is a black box which plugs into the 1MHz bus and allows a wide variety of input/output types.

The box measuring 3in x 4½in is covered on all sides with a variety of sockets allowing all sorts of devices to be connected into your micro.

To begin with there is an 8 bit digital input port and a ditto output port. Both are mapped to the same address on the 1MHz bus so that to output a byte you simply write to the address (using `&FCC2=A%`). To see what is on the inputs simply read the address, using `A%=?&FCC2`.

Note that the eight bits on the user port can be either inputs *or* outputs, but with this device you have eight of each.

Next are four switched inputs. These are very similar to the eight digital inputs except they are pulled down internally and so need switching to 5 volts to register their value.

Moving along the side of the box there are four relay outputs. They make a small clicking noise as they pull in. All the relay contacts are rated at 12 volts at 1 amp.

A single contact is brought out on the box for each relay and a single common connection, thus the loads switched by the relay must have a common connection.

They cannot be independent, although you could easily unscrew the lid and wire the relay contacts separately.

Along the other side of the box are eight analogue inputs. These are connected to a single 8 bit analogue-to-digital converter. You first need to select a channel to convert and then you can read the results.

As conversion time is about 0.1 milliseconds you can read the result in the next line of Basic. As it is 8 bits it will return a value between 0 and 255 for voltages from 0 to 2.45 volts (+/- 5%).

If you are really cunning you could scan each channel as part of the interrupt service routine just like the analogue input on the BBC Micro.

Finally, along the top side is the DCP

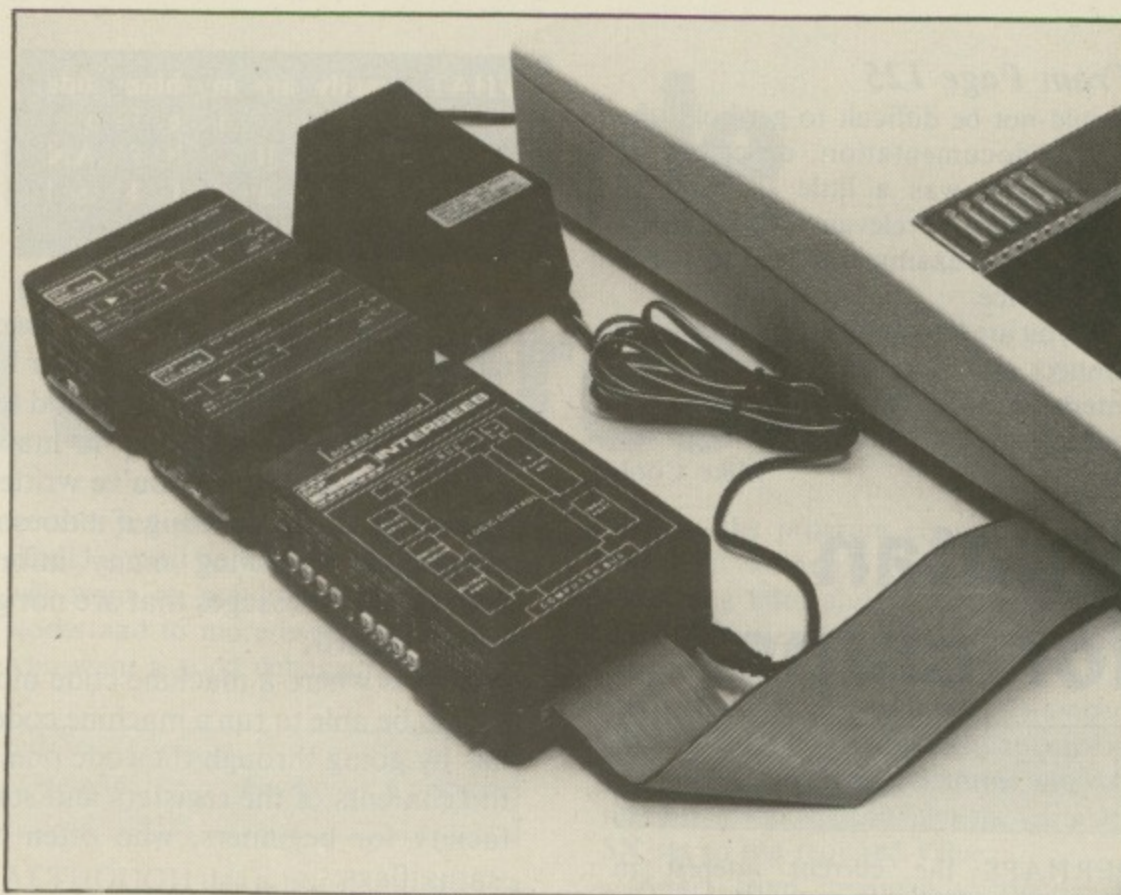

Get more out of (and into) your micro with a little black box

bus socket. This allows extra modules to be connected end-to-end in domino fashion. Two of these extra modules were also loaned for this review – a fast analogue/digital converter and a digital/analogue converter.

The A/D converter, unlike the one in the main box, has a single input, but like the other one also has 8 bits resolution. However it is much faster and can perform the conversion in about 10 microseconds – 10 times faster than the main box.

However like the box there is no way of telling when the conversion process has finished. This is no problem with a Basic program but in machine code you will just have to experiment to find exactly how long you have to hang about before the result is ready.

The D/A converter will produce an

analogue signal in approximately 10 millivolt steps. This means that if you store 100 at its address location you will get a 1 volt output.

A nice touch is that all the modules have labels on the top with a diagram of the function of the module enabling you to better appreciate what is going on inside.

All the modules are powered from a separate calculator type mains adaptor capable of producing 500mA. The Interbeeb is at a fixed address on the 1MHz bus (&FCC0 to &FCC4) and so only one may be connected to the machine at any one time.

The plugs and sockets needed to make the connections to the boxes are not provided, but are standard and

From Page 125

should not be difficult to get hold of.

The documentation, described as provisional, was a little sketchy but contained all the relevant facts and a few simple Basic examples of how to access each device.

If you are looking for a simple way to connect more into your Beeb then the Interbeeb might be just what you are looking for.

Mike Cook

Suntan for chips?

Uvipac eprom eraser *Ground Control*

PERHAPS the current interest in eprom programmers is because many people are developing ROM-based software. If you are one of them, before long you are sure to need an eprom eraser – unless, that is, you never make any mistakes.

The trouble is that most erasers seem to cost more than you would wish, for after all they are just an ultraviolet lamp. Or, as I would have it, an ultra violet lamp.

However most commercial products do have built-in timers to control the degree of suntan you give your chips, as well as safety devices to prevent any harmful rays assailing your eye balls. This quite naturally increases the cost and puts them out of reach for hobby applications.

Now Ground Control has come up with a stripped down version at a stripped down price – a small black box just over 3in square.

On one side is a small flap that can be raised to accommodate three eproms. The unit then plugs in the mains and 20 minutes later your eproms have more than a touch of instant amnesia.

The unit did work but the conducting foam carrier keeping the eproms in place had the habit of getting jammed inside. Also there was no indication of whether the unit was actually on apart from it getting hot.

If you are going to use it occasionally then it is perfectly adequate for the job. But if you want to erase any number of eproms on a regular basis then you will just have to cough up the extra money.

Mike Cook

WHAT exactly are machine code monitors, and how can they help us program? Here JIM NOTMAN assesses two of the latest ROM based monitors.

AFTER getting to know Basic many will want to learn how to write 6502 machine code using the assembler built into Basic. This may be just to write fast or specialised routines to add to Basic programs, or possibly programs that are written completely in machine code.

Unfortunately once you've written the code and had it assembled it's not as easy as Basic to debug if it doesn't work as expected. Basic has the great advantage of having many informative error messages to help with debugging – messages that are not given in machine code – unless you write them yourself.

This is where a machine code monitor helps. With this software tool you should be able to run a machine code program, checking what effect the code has by going through the code one step at a time (single stepping), showing the contents of the registers and status flag. This is an especially important facility for beginners, who often have difficulty with the settings of the status flags.

Beebmon *Watford Electronics*

AFTER starting up Beebmon by typing in *MONITOR, Mode 7 is selected and a little command strip is displayed along with a command request.

These commands fall into two types – those concerned with memory display and modification and those with program execution.

The memory display and modification commands include disassembly of code, hex and Ascii dump of memory. The cursor keys control the position of the cursor, allowing scrolling both upwards and downwards, and the place where editing takes place, simply by overtyping previous values.

Then editing the disassembly allows it to be used as a simple assembler.

Memory tasks include:

- Fill a block of memory with a specific value.
- Give the Checksum of a memory block.
- Move memory.
- Relocate memory. This alters code to act as if it were at a different address.
- Search memory for a string or series of bytes. Send a * command for any operating system call.

Inputting the commands was easy and clear, simply by pressing one or two letters without the need to press Return. Other details, such as a start address, would then be requested. The cursor can

Monitor yo

be moved left and right within an input field by the cursor keys so that mistakes can be corrected.

The simplest way of seeing what the monitor will do is to look at a screen of output from a short piece of code which transferred the screen memory (see *Figure 1*) into another area of RAM before being *SAVED.

As you would expect on a machine code monitor the registers can be individually set before debugging.

As seen in *Figure 1* up to nine columns of information are given. The seven left hand columns are what you expect a monitor to have with the current location, disassembly of code and the contents of the registers. The two right hand columns give the address of the operand and its contents – very useful with machine code which uses much in the way of indexed or indirect addressing.

The bottom row contains the values of the registers, including the separate flags that make up the status register.

Instead of single stepping, sections of code can be emulated. This is where breakpoints are needed. They can be placed in any position you want to halt the program and examine the registers.

In Beebmon these breakpoints are used in a far more flexible way than in the majority of monitors. This is because a table is referred to before each step of program execution, so that breakpoints can be set, even in ROM.

Conditions can be attached to the

for your machine code program's progress

breakpoint, for example to cause a break when the accumulator or X or Y registers has a particular value or when a location is being written to.

The single stepping and emulation can be used with any page ROM as well as RAM. Even Beebmon can be examined in this way.

Trace limits can be set, so that only code between given addresses are shown, avoiding displaying calls that are made outside the code you are interested in.

Much of the screen output can be directed to either the printer or a file on the currently selected filing system. This is necessary when debugging routines where the screen must not be disturbed.

One page of memory is reserved as workspace, normally at &0400, but this can be moved if page &4 is needed. A short 19 page spiral bound manual details all the commands and some examples of use.

Watford Electronics are honest enough to include a section on what their software cannot do, mainly emulating interrupts and storing the VDU queue, which are rather complex and specialised pursuits.

This machine code monitor is simple

to use yet powerful in operation. It should appeal both to the beginner who will want to see how machine code works and to more experienced hacks who want a good debugging facility.

Gremlin *Computer Concepts*

ALTHOUGH this is also described as a monitor and debugging aid, it could hardly be more different from Beebmon. It's not the sort of package you can jump into without first painstakingly going through the manual.

When Gremlin is entered it stays in the currently selected screen mode. A large amount of information is printed on the screen in 40 and 80 column modes, as part of the 'status display' (Figure II).

The top row shows the contents of the accumulator, X and Y registers along with the individual flags of the status register. The second row gives the stack pointer plus the bytes that are being pointed to. Similarly the third row gives the program counter plus a number of bytes that are pointed to.

The next line will disassemble the

code at the program counter or print ??? if it is not a valid code. The remaining lines give a hex dump with Ascii equivalents of memory pointed to by a variable called \$M.

Gremlin is characterised by a number of system variables. Rather than have a command to set, for example, the X register, it will want to have the variable \$X set to the required value.

Apart from commands concerned with memory manipulation and program execution, this package has an assembler and an extensive expression evaluator.

First, a look at some of the memory manipulation commands:

The memory of the status display, pointed to by \$M, can be edited by punching in data, in bytes, words, strings or even an assembly statement.

The memory pointer can be altered by an expression like \$M=3000 or by adding or subtracting a value from the pointer with + and -.

There are other commands for searching for data, moving data, tabulating memory (in hex and Ascii)

Watford BEEBMON Electronics										
Execution mode										
Command :										
Loc	Op	Operand	A	X	Y	P	Opad	Op		
3000	LDA	#7C	00	00	00	00				
3002	STA	A1	7C	00	00	30	00A1	53		
3004	LDA	#00	7C	00	00	30				
3006	STA	A0	00	00	00	32	00A0	FF		
3008	STA	A2	00	00	00	32	00A2	0A		
300A	LDA	#40	00	00	00	32				
300C	STA	A3	40	00	00	30	00A3	00		
300E	LDY	#00	40	00	00	30				
3010	LDA	(A0),Y	40	00	00	32	7C00	83		
3012	STA	(A2),Y	83	00	00	B0	4000	83		
3014	INY		83	00	00	B0				
3015	BNE	3010	83	00	01	30				
3010	LDA	(A0),Y	83	00	01	30	7C01	9D		
3012	STA	(A2),Y	9D	00	01	B0	4001	9D		
3014	INY		9D	00	01	B0				
Acc. X Y S PC NU=BD#40										
00	"	"	00	01	FA	3000	10110000			

Figure I: Beebmon disassembly

A=20	X=00	Y=00								
S =01FF	89 10 E3	B8 93 93 DC 89	: : : : : :							
PC=3000	A9 7C 85 91 A9 40 85 93	: : : : : @ :								
	LDA #7C									
	2FF0 00 00 00 00 00 00 00 00	: : : : : :								
	2FF8 00 00 00 00 00 00 00 00	: : : : : :								
M =3000	A9 7C 85 91 A9 40 85 93	: : : : : @ :								
	3008 A9 00 85 90 85 92 A0 00	: : : : : :								
	3010 B1 90 91 92 C8 D0 F9 E6	: : : : : :								
	3018 93 E6 91 10 F1 60 00 00	: : : : : f :								

GREMLIN										
!\$M=3000										
!\$PC=\$M										
!SW JE 1										
!CALL 3000										

Figure II: Gremlin status display

From Page 127

and disassembly.

Code can execute by single stepping, with breakpoints or by a call. As you would expect all the registers can be set individually. When setting the X register, for example, you will be aware of the difference between = and ==. The == only expects one byte as in \$X==10, only altering the X register. The = expects two bytes.

If the X register is assigned two bytes, as in \$X=3080, the X and Y registers are treated as a pair so that the least significant byte is placed in the X register and the most significant in the Y register.

Apart from RAM, paged ROMs can be single stepped. These ROMs are selected with \$ROM.

Limits can be set on the code that is to be debugged, so avoiding display of code outside those limits. Output can be sent to a printer or a file so that graphics

routines can be debugged.

Breakpoints can be set, but only in RAM, not in ROM or even in RAM in a sideways ROM socket. They do not have conditions attributed to them like Beebmon's.

Gremlin has a full assembler capable of single or two pass assembly. Short routines can easily be typed in directly, but probably it is best to use a text editor to write the assembler program. Not surprisingly Wordwise is suggested! There are some differences compared with Basic and these are documented in the manual.

As I said, the expression evaluator is very extensive, being based on the language C. There is a command PRINT to print out the results of the expressions.

The operators + - * / for add, subtract, multiply and divide will be familiar to Basic users.

There are however a number of other symbols which will not be so familiar. Like &, which performs a bit-wise

AND, and % which performs a MOD.

Something new to Basic users will be << and >>, which do a bit shift left and bit shift right, for example PRINT value >>1 will printout value with its bit pattern shifted 1 bit to the right, which in binary arithmetic divides by 2. A more useful operator than you first think.

As well as system variables you can use your own variable names. As with Basic they may be up to 254 bytes long, with all characters both upper and lower case being significant.

This is a flexible and powerful package. A 32 page spiral bound manual gives all the commands with examples of how they may be used. Strangely, coming from a company which is best known for Wordwise, a piece of software which is simple and easy to use, this is complex and will take some time to know. But it does have a large number of facilities.

OK for the expert, but not really for the beginner in machine code programming.

Break the BBC sound barrier!

ATTACK POW!

EXPERIENCE A GREAT NEW DIMENSION IN MICRO SOUND!

The National Micro Centres hi-fi adapter allows you to bypass the BBC Micro's internal speaker and feed the sound signal into your own hi-fi or music centre.

- Easy to install - no soldering
- Three-position switch allows use of internal or external speaker - or turns off sound completely
- Full instructions supplied
- Fully isolated unit
- Much more than an additional speaker - allows full use of your amplifier's controls

Hi-fi adapter ONLY
£19.95
Inc. VAT
Carriage free

ROM extension sockets ONLY
£22.95
Inc. VAT
Carriage free

Turn your micro into a word processor, a disassembler, a multi-language machine, or a communications terminal - at the flick of a switch!

Once there was a physical limit to the number of ROMs you could use. But with our ROM extension socket you can now gain access to an infinite number of ROMs quickly - and safely.

- Zero-force insertion socket protects valuable eproms from damage
- Easy to install - no soldering
- Fits into the ashtray for easy access - no need to meddle with the micro's innards
- Full, simple to follow instructions supplied

Please supply _____ Hi-fi adapter(s) at £19.95 each inc. VAT

Please supply _____ ROM extension sockets at £22.95 each inc. VAT

I enclose a cheque/PO No. _____ for £ _____ made payable to: National Micro Centres

Please charge my credit card No. _____

Signed _____

Name _____

Address _____

National Micro Centres
36 St. Petersgate
Stockport SK1 1HL
Tel. 061 429 9580

POST TO: NMC, 36 St. Petersgate, Stockport SK1 1HL

Two new products from Voltmace

The Datapad 16b.

A fully travel key, 16 way keypad that plugs into the user port.

Complete with cassette software to make it fully programmable.

Datapad 16b £34.95.
Including VAT and P&P.



Made in England



The Delta 3b Twin.

An alternative to the ACORN joystick. Two analogue self centering joysticks wired to one plug, which plugs directly into the analogue or an Electron Plus 1 interface.

Delta 3b Twin £19.95 per pair.
Including VAT and P&P.

Obtainable from your Voltmace stockist or direct from:-



Callers welcome at the factory - Monday to Friday.

Voltmace Limited
Park Drive
Baldock
Herts
SG7 6EV
Telephone (0462) 894410

ACORN

EDUCATION
Algebraic Manipul
Peeko Computer
Business Games
Tree of Knowledge
Word Hunt
Word Sequencing
Sentence Sequen
Number Balance
Missing Signs
Chemical Analysi
Chemical Simulat
Chemical Structu
Jars
Temperature Con
The Examiner

LANGUAGES
Forth (*E £18.10
Lisp (*E £18.10
Microtext
Turtle
S-Pascal

GRAPHICS AN
Creative Graphic
Graphs + Charts
Picture Maker
Shirley Conran's
Collector's Catal
Membership Ma
Linkword - Fren
Linkword - Itali
Linkword - Spa
Linkword - Gern

BUSINESS
Desk Diary
Forecast
View Printer Dri
Personal Money
Database

GAMES
Philosophers Qu
Aviator (Disk £
Monsters (*E £
Snapper
Rocket Raid (D
Arcade Action
Sphinx Adventu
Cube Master
JCB Digger (Dis
Chess (*E £9.2
Sliding Block
Meteors (Disk
Arcadians (*E
Planetoid
Super Invaders
Castle of Ridd
Missile Base
Downtown to
Draughts and
Snooker (Disk
Starship Com
Hopper (Disk
Carousel
Kingdom of
Crazy Tracer
Droga
Free Fall (*E £
Meteor Missio
Gateway to Ka
Tetrapod

BOC

30 Hour B
Beyond B
Creative C
Graphs ar
Advanced
Forth Ma
Lisp Man
BCPL Use
Assembly
Advanced
6502 App
6502 Ass
6502 Ass
Basic for
Starting F
Introduct
Z80 Appl
Program
Basic Pro
Electron
Electron
Graphic
The Elec

P

p&h electronics Ltd

5 THE PARADE, YATELEY 22/24 GUILDFORD ROAD

NEAR CAMBERLEY, SURREY
Tel: Yateley 0252 877222

BAGSHOT, SURREY
Tel: Bagshot 0276 73078



BBC MICRO CENTRES

TELEPHONE OR VISIT ALL PRICES INCLUDE VAT

ACORNSOFT

EDUCATION	
Algebraic Manipulation	£9.95
Peeko Computer	£9.95
Business Games	£9.95
Tree of Knowledge (*E £9.20)	£9.95
Word Hunt	£11.90
Word Sequencing	£11.90
Sentence Sequencing	£11.90
Number Balance	£11.90
Missing Signs	£11.90
Chemical Analysis	£13.80
Chemical Simulations	£13.80
Chemical Structures	£13.80
Jers	£11.90
Temperature Control	£9.95
The Examiner	£9.95
LANGUAGES	
Forth (*E £16.10)	£16.85
Lisp (*E £16.10)	£16.85
Microtext	£49.85
Turtle	£16.85
S-Pascal	£16.85
GRAPHICS AND OTHER	
Creative Graphics (*E £9.20)	£9.95
Graphs + Charts (*E £9.20)	£9.95
Picture Maker	£9.95
Shirley Conran's Magic Garden	£9.95
Collector's Catalogue	£9.95
Membership Manager	£9.95
Linkword - French	*E £14.95
Linkword - Italian	*E £14.95
Linkword - Spanish	*E £14.95
Linkword - German	*E £14.95
BUSINESS	
Desk Diary	£9.95
Forecast	£11.90
View Printer Drivers	£9.95
Personal Money Management (*E £11.50)	£11.90
Database	£11.90
GAMES	
Philosophers Quest	£9.95
Aviator (Disk £17.65)	£14.95
Monsters (*E £9.20)	£9.95
Snapper	£9.95
Rocket Raid (Disk £11.50)	£9.95
Arcade Action	£11.90
Sphinx Adventure (*E £9.20)	£9.95
Cube Master	£9.95
JCB Digger (Disk £11.50)	£9.95
Chess (*E £9.20)	£9.95
Sliding Block	£9.95
Meteors (Disk £11.50) (*E £9.20)	£9.95
Arcadians (*E £9.20)	£9.95
Planetoid	£9.95
Super Invaders (Disk £11.50)	£9.95
Castle of Riddles	£9.95
Missile Base	£9.95
Downton to Doom	£9.95
Draughts and Reversi (*E £9.20)	£9.95
Snooker (Disk £11.50)	£9.95
Starship Command (*E £9.20)	£9.95
Hopper (Disk £11.50) (*E £9.20)	£9.95
Carousel	£9.95
Kingdom of Hamil	£9.95
Crazy Tracer	£9.95
Drogna	£9.95
Free Fall (*E £9.20)	£9.95
Meteor Mission	£9.95
Gateway to Karos	£9.95
Tetrapod	£9.95

ACORN/MIRLE BUSINESS SOFTWARE

(Disk - 40 Track)	
Invoicing	£24.95
Mailing System	£24.95
Accounts Receivable	£24.95
Stock Control	£24.95
Order Processing	£24.95
Accounts Payable	£24.95
Purchasing	£24.95

BBC/ELECTRON

Acorn Electron + Cover	£199.00
Electron Exp1	£59.00
BBC Model A + Cover	£299.00
BBC Model B Start Pack	£399.00
BBC Model B + Disc/Int	£469.00
BBC Disc Interface	£95.00
Speech Interface	£54.00
BBC Teletext Receiver	£220.00
6502 Second Processor	£190.00
Bit Stick	£390.00
Z80 Second Processor	£299.00

DISC DRIVES

Acorn/LVL 100K expands to double	£199.00
Acorn/LVL dual 100K	£350.00
Pace slim 100K	£160.00
Cumana 100K no P. supply	£165.00
Cumana 200K no P. supply	£180.00
Cumana 400K no P. supply	£240.00
Cumana 100K with P. supply	£190.00
Cumana 200K with P. supply	£220.00
Cumana 400K with P. supply	£250.00
Cumana dual 100K	£350.00
Cumana dual 200K	£370.00
Cumana dual 400K	£480.00
Cumana dual 200K 40/80 switched	£450.00
Cumana dual 400K 40/80 switched	£550.00
LVLDD disc int kit	£100.00

ACCESSORIES

Cassette Recorder	£24.00
Cassette with Counter + Din	£29.00
Joysticks SW Self-Cen PR	£17.50
J/S Analogue Self-Cen (LVL) PR	£20.00
Crackshot Joystick	£10.95
Micro Dust Cover	£5.00
R.H. ELE Light Pen	£44.00
TV Aerial/Computer Switch	£2.50
Plinth for Monitor	£18.50
ROM Exp Board - 4 Slot	£20.00
Viglen Sideways System	£19.95
Computer Desk + Mains Dist.	£55.00
BBKEY. Function Key Mask	£1.50
Flow Chart Template	£1.50
Datapen with software	£28.00
Computer Desk double width	£55.00
Mains distribution block with plugs	£7.50

MICROPOWER

Moon Base Alpha	*E £7.95
Moon Raider	*E £7.95
Nemesis	£7.95
Timetrek	£7.95
Galactic Commander	£7.95
Asteroid Storm	£7.95
Swoop	*E £7.95
Alien Swirl	£6.95
Laser Command	£7.95
Space Jailer	£6.95
Martian Attack	£7.95
Positron	*E £6.95
Zarm	£7.95
Intergalactic Trader	£8.95
Cosmic Combat	£6.95
Cybertron Mission	*E £7.95
Bumble Bee	£7.95
Caveman Adventure	£6.95
Felix + The Fruit Monsters	*E £7.95
Bandits at 3 o'clock	*E £6.95
Labyrinths of Lacoshe	£7.95
Croaker	*E £7.95
Danger UXB	£7.95
Cowboy Shootout	£6.95
Chess	*E £7.95
Killer Gorilla	*E £7.95
Hell Driver	£6.95
Demon Decorator	£6.95
Draughts	*E £7.95
Felix in the Factory	*E £6.95
Chemistry	£6.95
Constellation	£6.95
Physics	£6.95
World Geography	£6.95
Where	£6.95
Draw	£9.95

SUPERIOR

Galaxians	£7.95
Centipeds	£7.95
Invaders	£7.95
Space Fighter	£7.95
Alien Dropout	£7.95
Fruit Machine	£7.95
Frogger	£7.95
Road Runner	£7.95

MONITORS CTV

Microvitec 14" colour	£230.00
Microvitec 14" Medium Res	£335.00
Microvitec 14" High Res	£460.00
Sanyo 14" colour	£240.00
Sanyo 12" Green High Res	£120.00
Sanyo 12" green	£90.00
Sony 14" CTV with RF input	£229.00
Ferguson 14" Colour Monitor	P.O.A.
SABA 14" CTV REM + RGB	£245.00



UTILITIES/SOFTWARE

View Wordprocessor ROM	£50.00
View Sheet ROM	£50.00
Wordwise	£40.00
Wordprocessor ROM	£40.00
Disc Doctor ROM	£29.00
Graphics ROM	£29.00
Bee Bug Tool Kit ROM	£27.00
Bee Bug Exmon ROM	£27.00
Bee Bug Masterfile DISC	£19.00
Clares Replica II DISC	£12.00
Clares B. Base DISC	£23.00
BBC Ultracalc ROM	£70.00
BBC Tool Box CASS	£21.00
BBC Beyond Basic CASS	£11.00
BBC Typing Tutor CASS	£15.00
BBC Record Keeper CASS	£13.50
BBC Home Finance CASS	£9.50
Gemini Database 24K ROM	£129.95

BBC SOFTWARE

White Knight Chess	£11.50
Dr Who	£9.95
Home Finance	£9.95
Early Learning	£9.95
Music	£9.95
Computer Program 1	£9.95
Computer Program 2	£9.95
Painting	£9.95
Drawing	£9.95
Canyon	£9.95
Tax Calc	£17.00

PRINTERS

Epson RX80T	£260.00
Epson RX80FT	£280.00
Epson FX80	£400.00
Epson FX100	£560.00
Silver Reed EX500 Daisy Wheel	£340.00
Silver Reed EX43 Typewriter + Interface	£399.00
Nec PC 8023	£225.00
Cannon PW 1080A	£330.00
Tally MT80	£215.00
2000 sheets 9 1/2 in Fanfold Paper	£14.00

GEMINI

Cash Book Acc.	£95.00
Beeb Calc	£19.95
Inv. & Statements	Add £19.95
Commercial Acc.	£4.00 £19.95
Mailing List	for £19.95
Database	disk £19.95
Stock Control	version £19.95
Home Accounts	£19.95
Word Processor	£19.95
Liberator	£9.95
Missile Control	£9.95

BOOKS FOR YOUR BBC MICRO

30 Hour Basic - BBC/NEC	£6.95
Beyond Basic - BBC/NEC	£7.25
Creative Graphics - Acornsoft	£7.50
Graphs and Charts - Acornsoft	£7.50
Advanced User Guide	£12.95
Forth Manual - Acornsoft	£7.50
Lisp Manual - Acornsoft	£7.50
BCPL User Guide - Acornsoft	£15.00
Assembly Language Programming for BBC - Birnbaum	£8.95
Advanced 6502 Programming - Zaks	£10.25
6502 Applications - Zaks	£9.75
6502 Assy. Language Sub Routines - Leventhal	£14.25
6502 Assy. Language Programming - Leventhal	£12.95
Basic for Business - Hergert	£10.95
Starting Forth - Brodie	£15.25
Introduction to Forth - Knecht	£9.30
Z80 Applications - Coffron	£11.95
Programming the Z80 - Zaks	£13.95
Basic Programming for the Electron - Cryer	£6.95
Electron Assembly Language - Smith	£7.95
Electron Programming for Education - Hall	£5.95
Graphic Art for the Electron - Allan	£5.95
The Electron Book - McGregor	£7.95

*E For ELECTRON PLEASE STATE
FAST MAIL SERVICE - SAME DAY DESPATCH ON ITEMS IN STOCK

MAIL ORDER COUPON

Please send me:

1	4
2	5
3	6

I enclose cheque / P.O. for _____ P&P see below

Or please debit my Access/Barclaycard/Visa* (delete as applicable)

Card Number _____ Expiry date _____

Name _____

Address _____

Telephone _____



P&H ELECTRONICS LIMITED
Unit 3 - Hogwood Lane - Finchampstead - Berkshire RG11 4QW
CARRIAGE COSTS - Micro's, Monitors, Disc Drives, Printers £7
Books, Cassette Decks, Leads, Software 50p each item.
ACCESS, BARCLAYCARD VISA ORDERS WELCOME
CREDIT FACILITIES Instant credit up to £1,000. deposit 10%



OPENUP YOUR COMPUTERS POTENTIAL

WITH **BEL BASE** AND **MAILSHOT** FROM **BEL TECH**

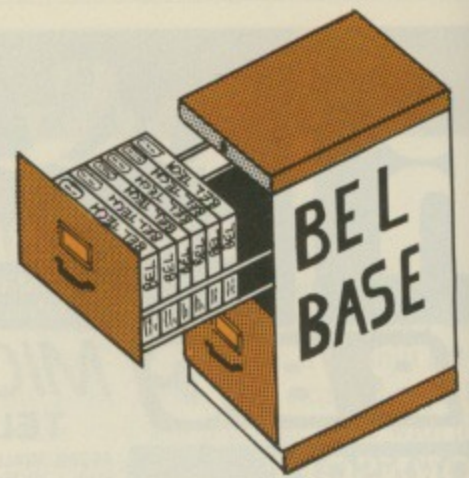

FLEXIBLE, POWERFUL, COMPREHENSIVE YET MENU DRIVEN AND EASY TO USE and INCREDIBLE VALUE FOR MONEY !!!

- * Up to 20 FIELDS and 150 CHARACTERS PER RECORD
- * 600 RECORDS or 90K Characters per File with truely RANDOM ACCESS Disc Version (15K Characters per File on Tape)
- * DEFAULT Values can be set
- * SELECT Disc Drives (0 to 3)
- * CALCULATION Options. Calculate a Field from the value of others, enter Functions etc. — and change them!
- * AMEND the Name, Type, Default Value of any Field
- * SEARCH and REPLACE on all Fields, all Records
- * SELECTIVE and GLOBAL EDITING of Records
- * INSERT Records, DELETE a Field or Record
- * BROWSE Option
- * FIND (Search on any Field) Print Screen if required
- * DISPLAY or PRINT Reports (max. 38/137 characters across)
- * PRINT all Records (2 Fields) or all Data
- * FORMAT OWN REPORTS (Heading, up to 20 Fields, select, sort etc.)
- * SORT on any Field (Ascending/Descending) whether Printed or not
- * SET CONDITIONS (<, >, <>, =, >=, <=) on any Field, printed or not
- * SAVE Report Formats to a File
- * SUM Numeric Fields
- * SEND Printer Control Characters
- * COMPREHENSIVE INSTRUCTIONS SUPPLIED

NOW AVAILABLE ON ROM
MAILSHOT — £36
BEL BASE — £69

MAILSHOT IS INCLUDED IN PRICE OF BEL BASE AS A BARGAIN PACKAGE!!

PERSONAL USE, BUSINESS, ACCOUNTS, EDUCATION, CLUBS, SOCIETIES, FUNCTION, GENERATION — JUST KEEP THINKING OF NEW APPLICATIONS!

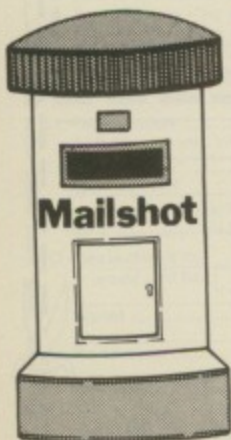

AND 'MAILSHOT' SEPARATELY:—

- * USE AS MINI DATA BASE
- * Field, Record Size, Amend, Edit, Search, Insert, Replace, Drive Selection, Browse, Find, Sort, Conditions, Printer Control as BEL BASE above.
- + * LABEL Printing (Std., non std, 1, 2, 3, across)
- + * PRINT any 6 Fields Across
- + * PRINT any 6 Fields Down



Order Form	TAPE		DISC		TOTAL
	QTY		QTY		
BEL BASE		16.00		18.00	
BEL GRAPH		15.00		17.00	
BEL CHEM Chemistry 1		9.50		11.50	
Chemistry 2		9.50		11.50	
BEL GEN Geneology		12.50		14.50	
MAIL SHOT		9.50		11.50	

TOTAL inc. P. & P. £

NAME _____
 ADDRESS _____

 COMPUTER TYPE _____ MODEL _____
 DISC (if applic.) _____
 CREDIT CARD No. PAYMENT BY CHEQUE. P.O. VISA. ACCESS _____

Please Complete & Return to:-
 BEL TECH Limited, Stanmore Industrial Estate, Bridgnorth, Shropshire. WV15 5HP. or
 Telephone: 07462 5420 (24 Hrs.)

FILES ARE COMPATIBLE WITH BEL GRAPH

A Hardware Guide For The BBC Microcomputer.

A 260 A4 PAGE BOOK WHICH INCLUDES:-

- ★ Comprehensive circuit description.
- ★ Full step-by-step details on upgrading Model 'A' to Model 'B'.
 - ★ Full details on fitting disc and speech expansions.
 - ★ Full explanation of all link settings and functions.
- ★ Full of circuits, hints, tips and modifications (many previously unpublished).
 - ★ Full manufacturers data sheets on all major IC's including:- R6522, 8271, 6502, MC6845, MC6850, SN6489AN, UPD7002, SAA5050, HM4816, 2764, 27128, 7400 series pin-outs.

A MUST FOR BOTH ENTHUSIAST AND ADVANCED USER ALIKE

To order send cheque/PO for £11.95 plus £1.50 p+p (UK only)
 (Overseas readers — printed paper rate surface mail — £3.00 p+p — air mail extra).

ALSO AVAILABLE:-

- High quality dust covers for BBC Micro (grey) £3.95 plus 50p p+p.
- A large range of hardware add-ons including digital-to-analogue converter, fast analogue-to-digital converter, dual stepper motor driver, digital input/output boards.
- The 'Owl-Scroll' — a variable speed, hand held screen scroller.

All orders and enquiries to

WISE-OWL,

Hull Innovation Centre, Guildhall Road, Queens Gardens, Hull, HU1 1HJ.

BBC Model B
 (any OS, Basic I/II)

QUAL-SOFT

£9.95 Tape, £12.95 Disc
 (inc. VAT and p.p.)

REV1 * "LEAGUE DIVISION ONE" REV1 *

NOT SO MUCH A GAME, MORE A WAY OF LIFE!

You have just been appointed Manager of a newly promoted 1st Division Club, and it is up to you to transform this very ordinary side into one that can realistically challenge for the 1st Div. Championship within the next 5 seasons. You must assess your side's capabilities and then, through your youth policy and the transfer market, reinforce the strengths and eliminate the weaknesses. It's all so easy . . . or is it?

- * 42 match season. * Opposition: 21 of the current 1st Division sides. * Each side has its own strength and playing style. * Name your own team. * 30 players available. * Tactics: select your formation and players. * Correct player positioning essential. * Each player with his own individual skills. * Unique simulated soccer match. * 3mins graphics illustration of match progress. * Substitutions and in-match tactical adjustments. * Injuries and dismissals. * Penalties. * Goal scorers. * Post-match statistics. * Match by match upgrade of League position. * Gates, gate money. * Transfer market. * Seasons scoring records. * Injuries/suspension list. * Players for transfer list. * 4 Levels of play. * 7/8 minute match cycle; 5/6 hour season cycle; 25/30 hour game. * 2 key-stroke SAVE/LOAD game facility. * 20 page manual + 12 page supplement. * and much more.

QUAL-SOFT comments: At last a true SIMULATION. In all soccer management games so far the opposition is represented by a sequence of numbers, the players by a sequence of numbers, and you match numbers against numbers. Team names and players are irrelevant. An interesting computer game perhaps but not soccer management simulation. Because of its UNIQUE soccer match, with the teams represented by a balance of skills competing against your blend of individual player skills, LD1 demands that you SIMULATE the activities of a real soccer manager. No numbers, but players, skills and blending these into a successful team. It's the difference between reading Log Tables and a good novel. HEALTH WARNING: LD1 can cause loss of sleep.

* Current Owners. As promised, return your original cassette and case with just £1 (£3 Disc) to cover p&p, re-recording of LD1 REV1 and the REV1 supplement. (Keep your present 20 page LD1 booklet.)

QUAL-SOFT
 Dept. CES
 18, Hazlemere Rd.,
 Stevenage,
 Herts.
 Tel: (0438) 721936

Please supply a copy of LEAGUE DIVISION ONE. I enclose cheque, postal order, ACCESS card authorisation for £9.95/£12.95

NAME:
 ADDRESS:

 CARD NO:

**SUPERB
REVIEW!**

FIRST AID!

DUALSCREEN MONITOR ROM



AID is now clearly established as the finest machine code monitor ROM for the BBC Micro. Designed for beginners and experts, AID is both powerful but still very easy to use. With a comprehensive set of over 40 commands AID will satisfy the demands of the most experienced programmer. Beginners also will soon feel at home with AID's friendly prompts and responses which make it such a good learning aid.

AID can tackle many tasks, from debugging machine code programs to revealing the secrets of machine code games using the unique and highly acclaimed DUALSCREEN graphics feature. Delving into the mysteries of the OS ROM you will find AID a source of lasting interest.

If you are taking your first tentative steps into the world of machine code or planning to write a chart topping machine code game then you can have no finer help than DUALSCREEN AID.

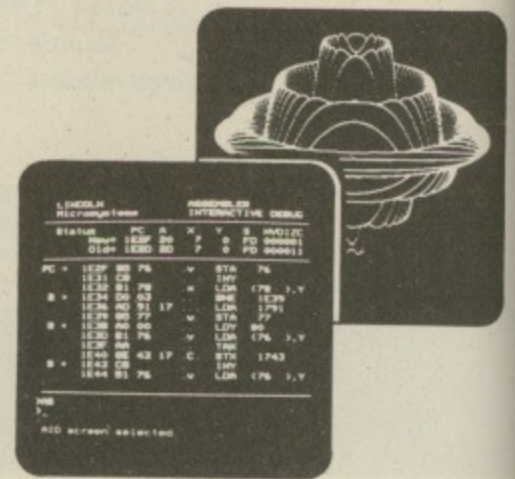

Acclaimed by the press and users alike . . .

“My immediate impression of AID was that it was a very professional product . . . AID offers additional features far in advance of other monitors . . . I found it easy to use, particularly as the user guide is very thorough and accurate . . . I wish I had something like this when I first started dabbling in machine code . . . The last facet I explored was the DUALSCREEN facility, which is perhaps the pearl of the system . . . In conclusion, AID seems a must for the serious machine code programmer and a very useful learning aid for the novice, it is a highly professional product in every way and could prove to be the standard by which others are compared.” *“The Micro User” January 1984*

“Having had your AID ROM ‘under the bonnet’ for two whole weeks I am at last able to escape its fascination in order to say how delighted I am with it . . . As a beginner at assembly language programming, I am finding your ROM not only a very useful tool but also a real revelation, like having a window into the 6502 and the whole working area of the micro . . . It is very impressive and I am grateful that such a powerful facility exists at all . . . I cannot see how such an impressive feat of programming as your incredible AID facility can be anything other than a runaway success . . . I would like to add my grateful thanks.” *C. D., Portsmouth*



CASSETTE – The original cassette version of AID (fewer commands) is still available. Easily transferred to disk. Price £10.00 + p&p for cassette plus 25 page manual.

AID ROM
plus
42 page
user manual

£28

p&p add
UK £1.50
Europe £3.00
Outside Europe
£4.50

The most advanced machine code AID for the BBC Micro

**LINCOLN
Microsystems**

P.O. Box 74
Bradford,
West Yorks. BD6 3RN

Lincoln Microsystems is a trading name of Horae Computer Systems Ltd.

PROGRAMMERS!

Lincoln Microsystems will consider high quality BBC Electron Software for marketing in the UK and abroad. Advice and assistance is available for promising products. Excellent royalty cash purchase package.

Rollerball

By GEOFF
TURNER

REMEMBER those little plastic maze toys containing several ball bearings? By tilting the maze in various directions, it was possible to steer the balls into the central section of the maze.

Of course it's quite easy to get one or even two balls into the centre, but they soon find their way out again if you tilt in the wrong direction.

Here is a program which simulates one of these toys. It even gives you the option of choosing how many balls you wish to use.

If you find the game too easy, using the invisible maze should soon bring you down to earth!

Complete instructions for playing the game are contained in the program listing.

Here's how it works:

A short machine code program is assembled at lines 100 to 190. This is used to assist in the continuous flow of music while the game is being played.

It is necessary to check the status of the sound buffer to see if room is available to add more notes to the queue.

The machine code is called in

PROC MUSIC at line 3140.

Two procedures are used to initialise the variables. PROCINIT1 sets those variables which only require initialising at the start of the game. PROCINIT2 initialises variables which need to be reset after every game.

These procedures are called at lines 210, 220, followed by a call to PROCINSTRUCTIONS, which displays a description of the game and the playing instructions.

A large chunk of the program is taken up by the procedure to set up the screen display between lines 500 and 1440.

Basically a number of green squares are drawn on the screen starting with the maximum size, and reducing each one by 64 pixels.

The final square is drawn in yellow to show up if the option to use an invisible maze is taken.

The data in lines 1710 to 1880 is then used to develop the squares into a maze by closing off certain sections and making gaps at various points in the squares.

Also in PROCSCREEN the arrows

to indicate direction of tilt are drawn and the elapsed time clock is printed.

The main loop of the program is fairly short, simply moving the balls in the current direction of tilt.

The main loop procedure also checks to see if any keys are being pressed to request a change of direction.

Note that *FX11,0 is used to disable the key repeat facility, so it is pointless holding down a particular key.

As the balls move around the maze it is necessary to perform a lot of checking using the POINT command to see if each ball has hit a wall or another ball.

PROC CHECK is therefore called from within the main loop before the balls are moved to their next position. Having decided the direction of the balls, it is necessary to check no less than eight points around the ball.

Unfortunately all this checking does tend to slow the balls down a little, so I have compacted the main loop procedure into multi statement lines where possible to help keep the speed up.

A further important check is necessary after each movement of the balls to see if they have all entered the central square. PROCWIN is used to carry out this check.

Note that if any ball is found to be outside the centre then the procedure is terminated without checking the other balls.

If PROCWIN returns E%=1 then the mainloop is terminated and a suitable comment is made depending on the value of T% from PROCTIME.

The data in lines 3110 to 3130 are the notes used in PROC MUSIC to produce an accompaniment to the game.

Users with a disc interface fitted may have a memory problem. It will be necessary to lower PAGE before running the program, or use a downloader routine.

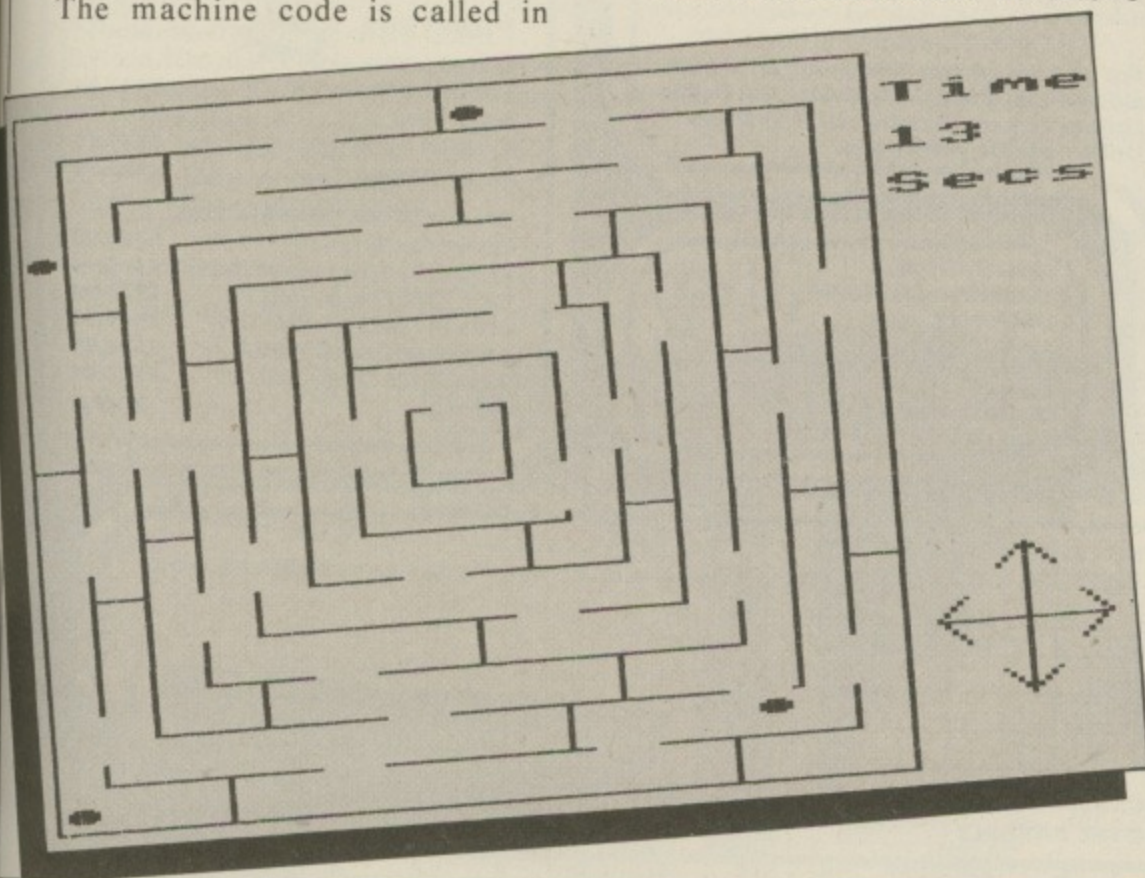

Listing starts
on Page 152

Micro Resources Limited

Southfield House, 11 Liverpool Gardens, Worthing, Sussex BN11 1RY
Telephone: Worthing (0903) 213174

BBC Model B	£399.00
BBC Model B Disc Interface	£469.00
BBC Model B Econet	£446.00
BBC Model B Econet & Disc	£516.00
Acorn Electron	£199.00

Acorn 6502 2nd Processor £199.00

This allows the BBC Model B to run faster with greatly increased memory especially in high resolution graphics modes, the package includes Tube software, the latest version of the DFS & NFS called DNFS, a Rom containing Hi-Basic and a comprehensive User Guide.

Acorn Z80 2nd Processor £299.00

If you have wondered how to make the best use of your BBC for Business, then the Z80 2nd Processor and CP/M must be the answer. This package comes with a suite of business programs, including Memoplan, Fileplan, Graphplan, Accountant, BBC Basic (Z80 Version), Cobal, Neculeus (Programming Aid), Professional Basic. This software alone is worth hundreds of pounds and with CP/M you can buy any of the programs written for this operating system.

Dual 800K Disc Drive £359.00

Superb British made disc drive unit ideal for use with the 280 2nd processor.

Acorn Teletext Adaptor £225.00

Allows the downloading, storing and running of programs via Ceefax, transmitted free of charge, pages can also be saved and printed from all 4 channels.

Acorn Bitsik £375.00

This superb menu driven graphics package allows high quality CAD at a modest price. Needs 6502 2nd Processor and dual 80 track discs drives, a must for all design teams.

Acorn IEEE 488 Interface £325.00

Provides computer control of compatible scientific and technical equipment. Useful in experimental work in industry and education.

Acorn Word Processor View £59.00

This Rom based word processor has many advanced features including macros, still one of the best available on the market.

Acorn Spreadsheet Viewsheet £59.00

A new spreadsheet from Acornsoft comes in a 16K Rom with a comprehensive manual, it is compatible with view and the 6502 2nd processor.

Mass Marco Assembler £35.00

A superb machine code assembler in Rom, includes comprehensive manual where the user is introduced to Mass and given step-by-step guide to writing source code and assembling it using Mass. Also includes a utility disc with many useful routines.

All prices include VAT and delivery

99% OF ALL BBC SOFTWARE CAN NOW BE PLAYED ON JOYSTICK

Wizard Development have brought out two simple-to-use accessories for your BBC Micro that will enable you to not only make the most of your machine's capabilities, but enjoy for the first time full joystick control over almost the entire range of BBC Software.

£17.50
Plus P&P*

JOY ROM

Converts keyboard only games to full joystick control, can be used with any existing BBC joysticks. No software required, simply insert the JOY ROM

£14.95
Plus P&P*

JOYSTICK INTERFACE

Now use any Atari type joysticks on your machine (two joystick sockets) Also available Quickshot II Joystick at only £9.95 plus P&P*



SPECIAL MAIL ORDER OFFER. THE ROM AND INTERFACE FOR CHEQUES MADE PAYABLE TO WIZARD DEVELOPMENT.

£29.95
Plus P&P*

*Post & packaging 60p single items, £1.00 special offer.

AVAILABLE FROM ALL GOOD COMPUTE DEALERS OR DIRECT AT OFFER PRICE FROM WIZARD DEVELOPMENT, 22 CARVER STREET, SHEFFIELD S1 4FS Dealer and distributor enquiries welcome. Telephone (0742) 752732

Tune in to a digital frequency meter

THE BEEB BODY BUILDING COURSE

Part 18

I HAVE had several letters from readers wanting to find some way to tune their guitars using the BBC Micro. This sounded a strange request at first and so I discussed it with the editor.

He must be a little more wily than we give him credit for, because he said the one thing guaranteed to make me tackle a project: "So you can't do it then?" Thus galvanised, I set out to see how it could be done.

The solution is to make the computer into a digital frequency meter. This is useful, not only for tuning instruments, but for all sorts of measurements such as hi-fi and general laboratory work.

I remember when I first went to work after leaving school, the pride and joy of the electronics lab was a digital frequency meter. It had a neon display that would "spin" and then briefly display the frequency before spinning around again.

At the time it cost the equivalent of a new Mini Cooper, but then electronics were expensive in 19** (Blast, I must get this printer fixed).

The repetitive nature of the electronics needed for a frequency meter were ideally suited to implementation with integrated circuits, and before long it was possible to buy one on a single chip.

When setting out to convert the computer I initially thought of converting the signal into a DC voltage proportional to the frequency and then measuring it using the analogue input port. This only goes to show how wrong initial thoughts can be. It would have been quite inaccurate and required a fair bit of electronics to achieve.

The frequency of a signal is the number of cycles it goes through in one second. In the good old days this was measured in cps (units of cycles per second).

However when we joined the Common Market this was all too simple

for the French, and so the units of frequency were changed to Hertz, after a German physicist and part time renter of cars. The strange thing is that one Hz (Hertz) is defined as one cycle per second. Still, that's progress!

There are two methods of measuring frequency. First you can count how many cycles there are in a second, and secondly you can time how long it takes for one cycle and work out how many there would be in a second.

Both methods are possible using the computer, and they can be implemented

By MIKE COOK

in several ways. The best is to use the facilities of the VIA (Versatile Interface Adaptor) which can be accessed from the user port.

The VIA contains two timers which can be used to measure frequency while the computer is getting on with something else. As we have not yet used these timers in earlier projects, it will be in order to say a little about them.

They are imaginatively called Timer 1 and Timer 2 and while they do similar jobs, they are not identical.

Timer 1 consists of two memory locations within the VIA (&FE64 and &FE65). These form a 16 bit number that is decremented every clock cycle.

As these memory locations are accessed at the same speed as the 1MHz bus, the number will be decremented once every 1uS. This happens automatically without the need for program intervention.

When these locations reach zero the VIA can generate an interrupt and a new number can be loaded in from Timer 1's latch register automatically.

The latch register (&FE66 and &FE67) is a sort of store used to remember the time interval you want

Timer 1 to use repeatedly. I say "can" because the timer can run in several different "modes" and these events will only occur if you have selected them.

The mode is determined by the bit pattern in the auxiliary control register (&FE6C). This location also controls the behaviour of Timer 2. The only reason why this may appear to be complicated is that, despite there being only a few events that can or can not happen, the number of combinations of events is large (256 combinations).

In addition to this, bit 7 of the B side of the User Port can be made to produce an output that changes with the state of the timer.

So this bit, along with the timer, may work continuously producing a square wave output whose period is twice that of Timer 1.

Alternatively, if the option not to reload the timers is chosen, it can produce a "single shot" pulse which lasts for the time given by Timer 1.

Timer 2 can operate in this same single shot mode, only using locations &FE68 and &FE69 to determine the time. There is no latch register for this timer and so it cannot be used on a continuous basis. Also no output is available (like bit 7 for Timer 1) to indicate the state of the timer.

It does however have one big advantage over Timer 1 in that it can be used as a counter. Instead of taking the computer's 1MHz E signal as the command to decrement a counter it can be programmed to use a signal that is fed into the VIA through bit 6 of the User Port.

So this timer can count external events and cause an interrupt after a predetermined number without any program intervention.

The VIA also contains a shift register controlled from the auxiliary control

From Page 137

register, but as this is not needed here we will leave explanation of its operation for another day.

Figure I shows how the bits in this register control the operation of the two timers. Armed with this information we can see one method of measuring frequency.

If the signal we want to check is fed into bit 6 on the user port we can count every cycle that is made. This in itself will not give us a measure of frequency. What we need to do is to count how many cycles have occurred in a unit of time. This unit of time can be specified by Timer 1.

In addition, we can use the bit 7 output from Timer 1 to "gate" the signals going into Timer 2. Thus Timer 2 is only decremented while Timer 1 is counting.

The procedure is therefore to set Timer 2 to the maximum value, start Timer 1 going, and when it is timed out look at the value in Timer 2. This will tell us how many cycles it has received during the timer of Timer 1.

As you are doing this by computer it can then do the "sums" to extract the frequency in cycles per second, sorry Hertz.

The only thing that needs to be added to the computer is the device that lets pulses through to Timer 2 while Timer 1 is going. This turns out to be simplicity itself. Figure 2 shows how it is done. Surprised?

The signal to be measured is applied to the input and this turns the transistor on and off in time with the signal. However when bit 7 is high bit 6 will remain high as there is nothing to pull it down.

Only when bit 7 is low can the transistor switching on and off make the signal on bit 6 go high and low. Thus the circuit acts as a gate and only lets pulses

through during the period defined by Timer 1.

The signal must be large enough to turn the transistor on. Anything greater than about 1 volt will work.

A program to measure frequency in this way is given in Listing I. The section to start the measuring operation is in machine code although it would work equally well in Basic.

I have tucked it away in the RS232 buffer, but it can be moved anywhere to suit your own requirements.

Timer 1 is set to the maximum time of 64mS to allow as many pulses as possible to be counted. Thus, 64mS after the call to the subroutine is made the number of cycles counted is waiting for us in Timer 2's counter (&EF68 and &FE69).

As the input decrements the count rather than increments it what we actually have is our initial number, minus the number of cycles we have had. This is calculated in lines 280 to 310. The result is then printed on the

screen and the program loops round to measure the frequency again.

As Timer 2 only counts edges the number of pulses counted must be a whole number. This means that the count could be up to one count short. When this is multiplied up to find how many pulses would have occurred in one second the result can be up to 16Hz in error. This is a constant error represents the resolution of the measurement.

Thus the percentage accuracy will be quite high for high frequencies (approaching 1MHz) and very low for frequencies below 100Hz. This is a factor of the "gate time" which, in our case, is 64mS.

If you want to measure really low frequencies accurately then you need a longer gate time. This cannot be achieved using Timer 1 but can be done using the computer's event timer. This allows an event routine to be called at intervals you can specify from the keyboard. The program will accept an

```

10 REM FREQUENCY COUNTER/TIMER
20 FOR AX=0 TO 3 STEP 3
30 PX=&A00
40 [
50 OPT AX
60 .SETUP
70 LDA #&A0 \T1 ONE-SHOT T2 COUNTD
OWN
80 STA &FE6B \AUX CONTROL REG
90 LDA #&FF
100 STA &FE68 \T2 INITIAL VALUE
110 STA &FE69
120 STA &FE64 \T1 LOW ORDER
130 STA &FE65 \T1 HI ORDER
140 RTS
150 ]
160 NEXT
170 CLS
180 PRINT"BEEB BODY BUILDING COURSE "
190 PRINT"FREQUENCY METER No. 1"
200 PRINT"By Mike Cook"
210 PRINT
220 PRINT"Counting the number of cy
cles in 64mS"
230 REPEAT
240 CALL SETUP
250 TIME=0
260 REPEAT
270 UNTIL TIME >8
280 AX=?&FE68
290 BX=?&FE69
300 CX=&FFFF-(AX+BX*256)
310 FX=INT(CX/.064)
320 PRINT TAB(0,13);"COUNT =" ;CX;SP
C(8)
330 PRINT "FREQUENCY =" ;FX;"Hz";SPC
(8)
340 UNTIL FALSE
    
```

Listing I

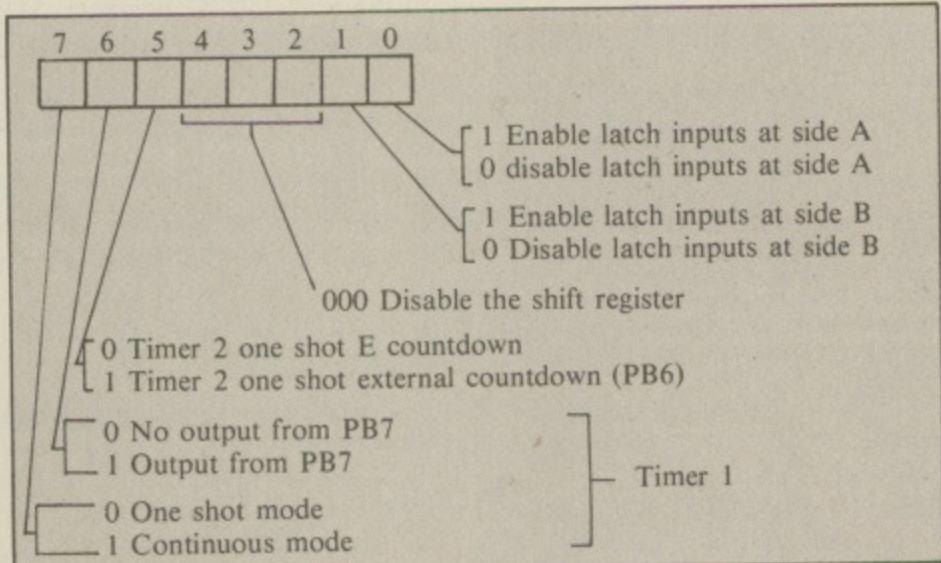

Figure I: Auxiliary control register &FE6B

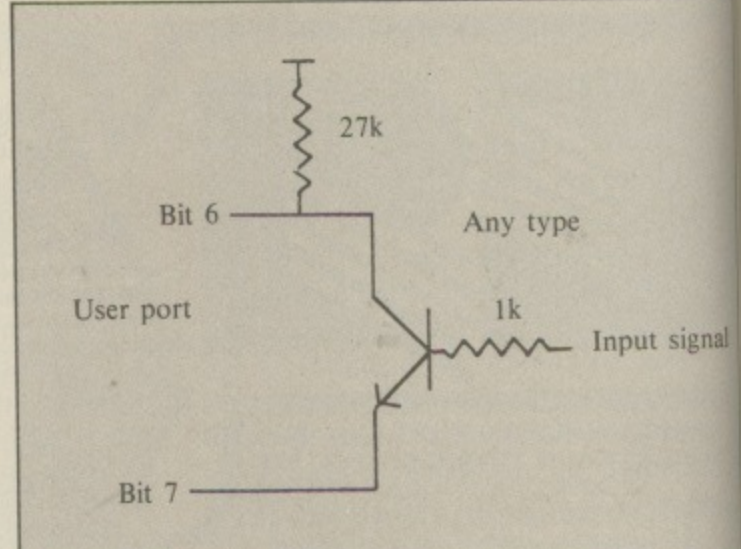

Figure II: Gating transistor

THE BEEB BODY BUILDING COURSE

the course of measurement you will get an average frequency recorded. To prevent this you need to measure the

ops round to time greater than 0.06 seconds.

gain. The event routine records the number of pulses left in Timer 2 in memory locations &7D and &7E and re-initialises the event timer. Listing II show how this can be done.

count short. You can specify the gate time you require and get the corresponding level of accuracy. Bear in mind the total number of pulses received in the gate time must not be greater than 65,535 (&FFFF) otherwise Timer 2 will "wrap around" and start again.

accuracy will be. Also when measuring really low frequencies (less than 10Hz) make sure that you have a good rise time on the signal. While testing I discovered that

only a square wave output from my signal generator gave a reliable result.

If you want to use low frequency sine waves you will have to square them up using a Schmitt trigger or saturating amplifier. In fact this program will work as an automatic background task even after you have pressed the Escape key.

To stop it totally you need to type *FX13,5 or hit the Break key. This means that measurements can be taking place while the computer is doing something else. However it is relatively slow and requires many cycles to determine the frequency.

The result is that if the signal you are trying to measure changes frequency in

```

10 REM FREQUENCY COUNTER/TIMER 1a
20 *FX13,5
30 ?&FE62=&80
40 ?&FE6B=&20
50 FOR AX=0 TO 3 STEP 3
60 PZ=&A00
70 [
80 OPT AX
90 .CSTART \ASSUME IT IS OUR EVENT
100 LDA #&80
110 STA &FE60 \CLOSE GATE
120 LDA &FE68 \STORE COUNTER VALUE
130 STA &7D
140 LDA &FE69
150 STA &7E
160 LDA #&FF \RESET COUNTER
170 STA &FE68
180 STA &FE69
190 LDX #&80 \POINT TO TIME VARIABLE
200 LDY #0
210 LDA #4 \EVENT TIMER WRITE
220 JSR &FFF1 \OSWORD ROUTINE
230 LDA #&1
240 STA &7F \INDICATE NEW READING
250 LDA #0
260 STA &FE60 \OPEN GATE
270 RTS
280 ]
290 NEXT
300 CLS
310 PRINT"BEEB BODY BUILDING COURSE
320 PRINT"FREQUENCY METER No. 1 a"
330 PRINT"By Mike Cook"
340 PRINT
350 REPEAT
360 INPUT"Enter the GATE time seconds ",G
370 GZ=G*100
380 UNTIL GZ>6
390 PRINT"Counting the number of cycles in ";GZ*10;"mS"
400 ?&220=CSTART MOD 256
410 ?&221=CSTART DIV 256
420 ?&84=&FF
430 !&80=-GZ
440 AX=5
450 CALL CSTART
460 *FX14,5
470 REPEAT
480 ?&7F=0
490 REPEAT
500 UNTIL ?&7F=1
510 AX=?&7D
520 BZ=?&7E
530 CZ=&FFFF-(AX+BZ*256)
540 FZ=INT(CZ/(GZ/100))
550 PRINT TAB(0,13);"COUNT=";CZ;SPC(8)
560 PRINT "FREQUENCY=";FZ;"Hz";SPC(8)
570 UNTIL FALSE

```

Listing II

```

10 REM FREQUENCY TIMER 2
20 FOR AX=0 TO 3 STEP 3
30 PZ=&A00
40 [
50 OPT AX
60 .FREQ
70 SEI
80 LDX #&FF
90 LDA #0
100 STA &FE60 \OPEN THE GATE
110 JSR TRANSITION
120 STX &FE64
130 STX &FE65 \ START TIMER
140 JSR TRANSITION
150 LDX &FE64
160 LDY &FE65 \GET COUNTER VALUES
170 STX &80
180 STY &81
190 LDA #&80
200 STA &FE60
210 CLI
220 RTS
230 .TRANSITION
240 LDA #&80
250 .LOOP1
260 BIT &FE60
270 BVC LOOP1
280 .LOOP2
290 BIT &FE60
300 BVS LOOP2
310 RTS
320 ]
330 NEXT
340 CLS
350 PRINT"BEEB BODY BUILDING COURSE
360 PRINT"FREQUENCY METER METHOD 2"
370 PRINT"By Mike Cook"
380 PRINT
390 PRINT"Timing one cycle 1 mS resolution"
400 ?&FE62=&80
410 ?&FE6B=0
420 CALL &A00
430 AZ=&FFFF-(?&80+?&81*100)
440 PRINT TAB(0,13);"TIME IS ";AZ;"MICROSECONDS";SPC(8)
450 F=INT((1/AZ)*1E06)
460 PRINT "FREQUENCY IS ";F;" Hz";SPC(8)
470 GOTO 420

```

Listing III

From Page 139

time period of one cycle and then work out how many of these will fit into one second.

This can be done with a machine code routine as show in Listing III. It first opens the gate and waits until a transition of the input (bit 6) has been detected. Then Timer 1 is started and on the next transition the number left in Timer 1 is a measure of how long it took.

However, even in machine code there will have been some time delay between the transition and starting the timer, but this is compensated for, as approximately the same time delay exists between the transition and reading the timer. As the computer normally runs under continual interrupts these have to be disabled while the timing is taking place to prevent the computer "being somewhere else" when the signal makes a transition and thus not being able to start/stop the timer accurately.

This has the unfortunate side effect that the computer will hang up waiting for a transition if no signal is being applied to the input. If this happens, only the Break key will bring it back to life. Using this method you can measure frequencies from 200 KHz down to about 160Hz (period of 64mS). This lower limit is given by the maximum time that Timer 1 can be set to run.

If you want to measure even longer single cycles you can arrange for the signal to go into control line 1 on the user port and to generate an interrupt every time a transition is made.

Again the internal event timer can be read and the frequency calculated. This will only be accurate on low frequencies due to the 10 mS resolution of the event timer. I will leave this one as an exercise for you to try. It will have the advantage of not hanging up when no signal is present.

If you want to increase the sensitivity of the signal input you can add some additional gain before the gating transistor. One way of doing this is to use an operational amplifier in the way we have done in the past.

Figure III shows how this may be done using an LM324. It basically consists of two stages of amplification followed by a Schmitt trigger. As the operation of these elements have been described in a previous article there is no point in repeating it.

Also note there is no kit this month as the single transistor gating circuit is so simple it is just not worth laying out a printed circuit board.

Using the amplifier you can drive the input from an electric guitar and use it to tune it up as originally requested, but I have also been doing some experiments recording the frequencies produced.

Listing IV shows an automatic music plotting program. It is based around the gated counter method of frequency measurement and takes successive measurements and plots them out on a music stave. Then it plays back what you have just played to it.

To do this a list of notes with their corresponding frequencies are read into an array. Lines 80 to 170 do this. As we are to cover three octaves the frequencies are halved and first time through and doubled the last time, thus only one set of data is needed.

As the array contains the actual frequency of a note it is adjusted in lines 180 to 220 to contain a threshold frequency for the note so that we do not need to be spot on with our input.

The effect is that the program will choose the nearest note in the key of C to the one you play.

The next section of the program, lines 230 to 290, defines the shapes to make up the note. The first character (code 240) is actually the black hole in the middle of some notes.

THE BEEB BODY BUILDING COURSE

Next the machine code routine is assembled and you are asked for the length of sequence you wish to record. The limit on this is set at line 40 and can be extended if you require.

The program then draws the music staves on the screen and plots the notes as you play them. It will only plot a note as it is finished, because it records the number of times it measures the input frequency and finds it the same to determine what note to plot on the stave.

As each note is plotted it is RECORDED in an array REC% for use when playing back the tune.

Finally, when the length of note sequence is reached, or the space bar is pressed, the tune is played back. If you want it can be repeated or you can try again.

I use the word tune very loosely, as the timing will inevitably be different from the original. I have tried it out with an input from my signal generator but not from any musical instruments and I make no promises about how good it is, only to say that it is "interesting"!

As an experiment I attached a microphone to the input and sang into it. The results were very interesting, but bore no relationship to what I sang.

There is obviously scope for further refinement here.

The major cause of difficulty was getting a good clean frequency signal from a source so rich in harmonics as the human voice. I found the vibrato kept coming through stronger than the fundamental frequency and this had the effect of putting in spurious notes.

Whistling was better, but I had to move the program up an octave as I tend to whistle at frequencies in excess of 1200Hz.

Nevertheless, it is great fun to try. It is very easy to turn the fact that it does not work very well into a feature - "It can be an aid to original composition".

Sing a well known tune into the computer and get something totally different out of it!

The single cycle timing method of

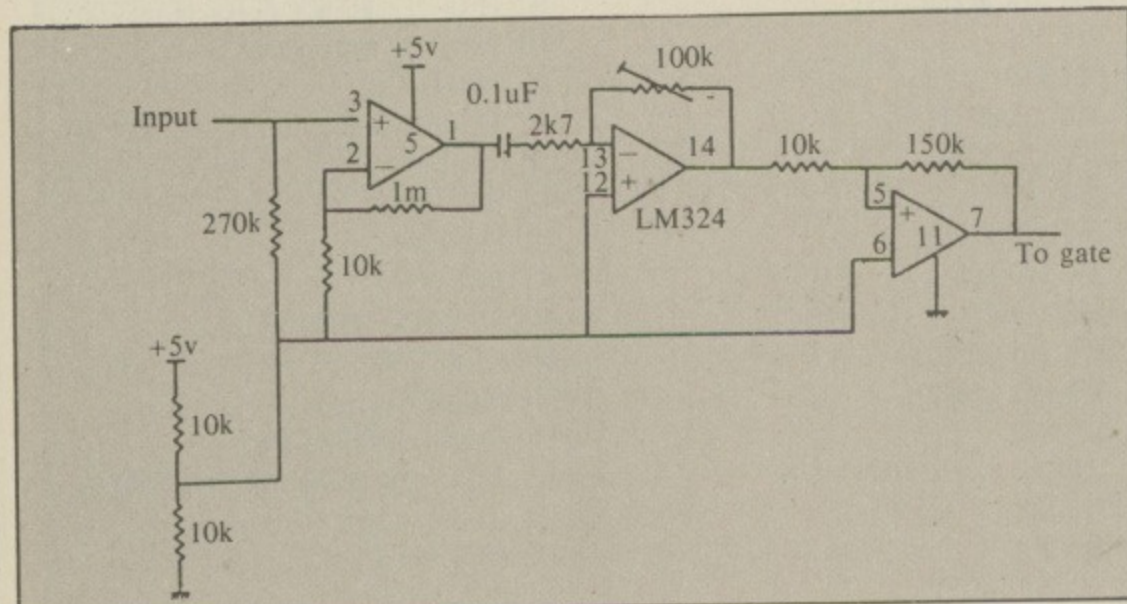

Figure III: Low level input signal amplifier

EB
NG
SE

outine is
for the
record.
and can
e music
he notes
ot a note
ords the
e input
ame to
e stave.
d it is
for use

f note
e bar is
If you
can try

ly, as
fferent
ut with
or but
s and I
d it is,
!"

ned a
nto it.
g, but
ng.
urther
was
signal
es as
brato
n the
d the
d to
as I
ccess

It is
s not
can
the
ally

of
→

PHONE FOR YOUR
NEAREST DEALER

ROM EXPANSION
BOARD
NOW ONLY
£45

DOUBLE
DENSITY
CONTROLLER
FROM £95

EPSON
DISK DRIVES
FROM £199 RRP

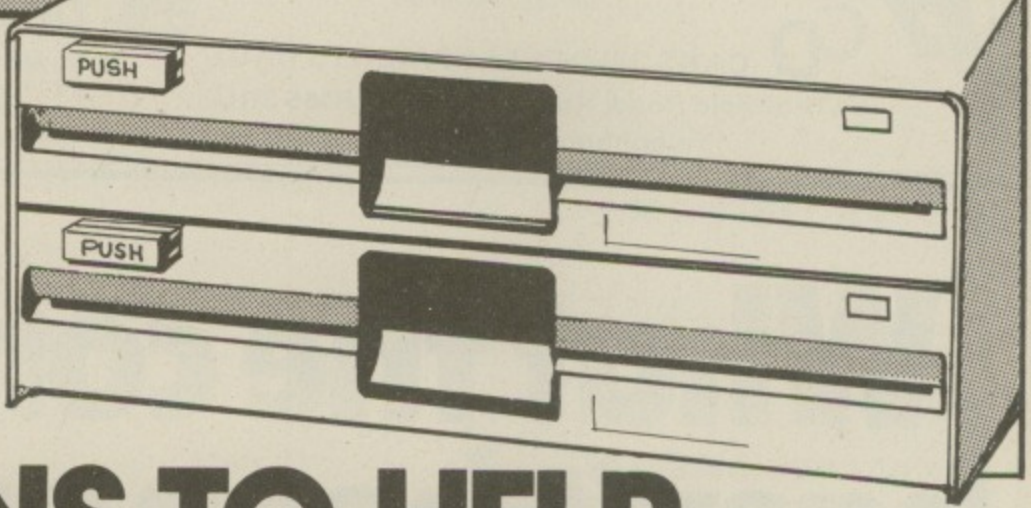
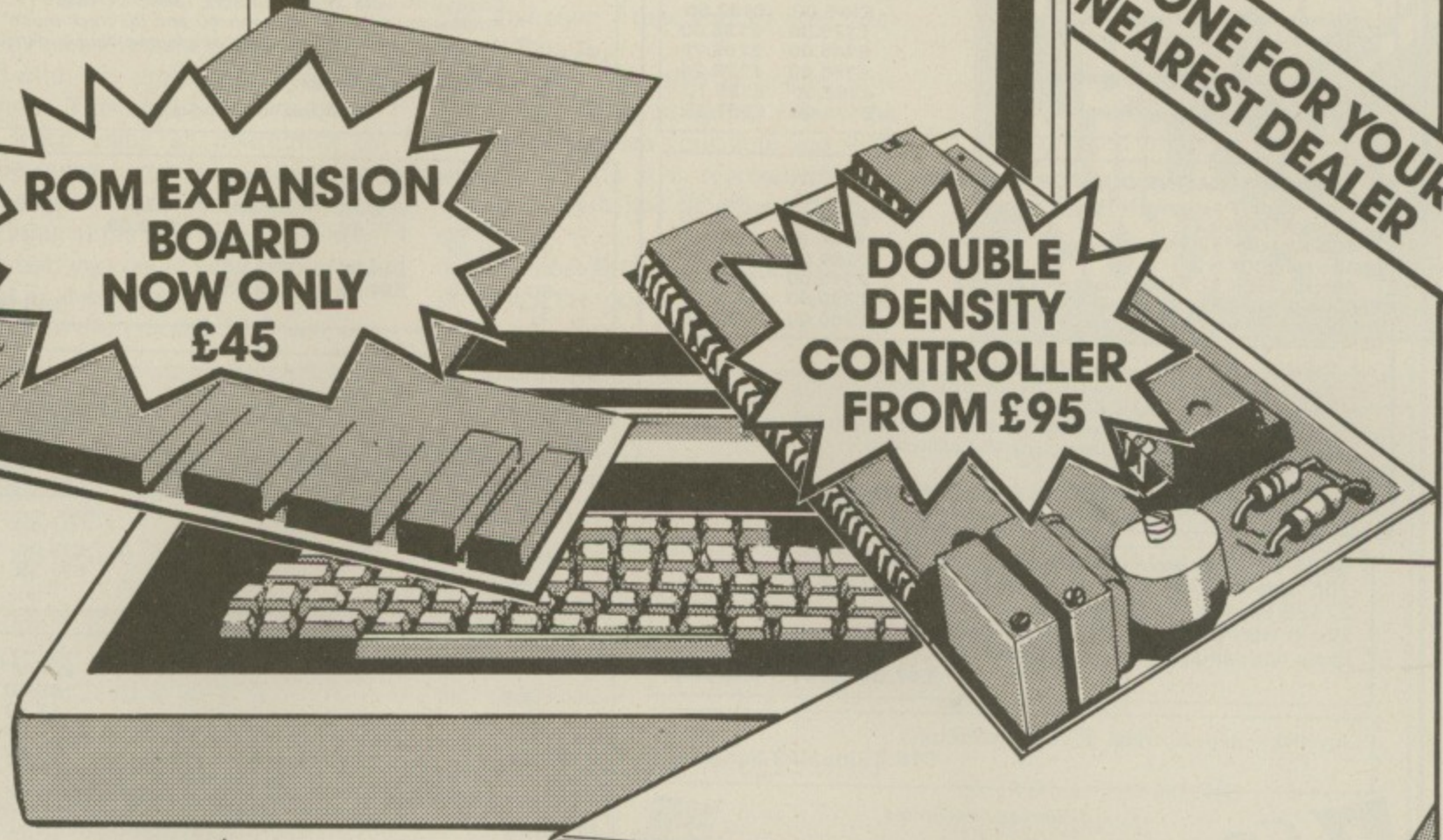

ADD-ONS TO HELP YOUR BUSINESS TAKE OFF.

If you are thinking of upgrading your BBC Micro, it makes sense to get add-ons that not only bear a reputable name but also have been designed specifically to be used in conjunction.

EPSON, manufacturers of the world's best printers, now bring you the world's best drives, including the industry standard 3 1/2 inch and 5 1/4 inch 40 and 80 track units.

These units are assembled in Britain by UDM for distribution through a dealer network.

All prices plus VAT

The Double Density Controller has been developed and manufactured by UDM specifically for the EPSON Disk Drives effectively doubling their capacity whilst maintaining compatibility with

- second processors
- teletext
- OSWORD 7F.

Additionally, a sideways ROM expansion board has been developed that is fully compatible with the above.

Send for full details of range available and prices or ring for your nearest dealer.

EPSON & UNITED DISK MEMORIES

Stanhope House Fairbridge Road London N19

01-263 5026

TANDON SLIMLINE SINGLE DRIVE UNITS

	ex VAT	inc VAT
40 track 100K	£115.00	£132.50
40 track 100K low power model	£120.00	£138.00
40 track 200K	£145.00	£166.75
40 track 200K switchable to read 80 track	£155.00	£178.25
80 track 400K	£165.00	£189.75
40/80 switchable 400K	£175.00	£201.25

TANDON SLIMLINE DUAL DRIVE UNITS

	ex VAT	inc VAT
40 track 100K x2	£230.00	£265.00
40 track 100K x2 low power model	£240.00	£276.00
40 track 200K x2	£290.00	£333.50
40 track 200K x2 switchable to read 80 track	£310.00	£356.50
80 track 400K x2	£330.00	£379.50
40/80 switchable 400K x2	£350.00	£402.50

- Other drives available – call us for details.
- All dual drives can be powered by the BBC Micro.
- Integral power supply is £30.00 inc VAT.
- The VAT inclusive price gives you a slimline metal cased drive/drives with all data and power cables, user guide and utility disc.
- Full 12 months guarantee.

Please add £8.00 for carriage by Securicor.
Allow 3 days for delivery.

ROM/RAM Sideways Extension by UDM

16K sideways RAM, write protectable. Selectable 2732, 2764, 27128 Eproms. No flying leads, no soldering – just plug in and go! Fits in with DDFS boards. 16 on board sockets. Turn pin sockets (does not damage existing sockets). Avoids overheating problems.
£47.00 inc VAT and p&p

Joystick – self centring, double fire button.

£18.25 inc VAT and p&p

Dealer enquiries invited

CD CARSON DEVELOPMENTS (MU)
84 Highfield Road, Romford, Essex, RM5 3RU
Telephone: 0708 27043

SINGLE/DOUBLE DENSITY FILING SYSTEM BY UDM

- Acorn compatible – runs BASIC, VIEW, WORDWISE, BCPL
- Compatible with 2nd processors, Teletext, Osword 7F
- Automatic switching between 40 and 80 track mode
- Automatic switching between single and double density
- Disc formatter in ROM
- Complete with manual

£100 inc VAT and p&p



DISKETTES (per box of ten) inc VAT + p&p

	Wabash	Datalife	Verex	Sony
40 tk ss sd	£14.50	–	£15.50	–
40 tk ss dd	–	£18.00	–	–
40 tk ds dd	£19.00	£24.00	–	–
80 tk ds dd	£24.25	£29.35	–	–
3 1/2"	–	–	–	£40.00

DRIVE CASES

	ex VAT	inc VAT
Slimline	£12.00	£13.80
Full height	£15.00	£17.25

Please add £2.00 p&p

LOCKABLE STORAGE CASES

	ex VAT	inc VAT
To hold 40 diskettes	£13.04	£15.00
To hold 80 diskettes	£17.39	£20.00

Please add £2.00 p&p

DRIVE CABLES

	ex VAT	inc VAT
Single Data	£8.50	£9.77
Single Power	£3.50	£4.02
Dual Data	£12.00	£13.80
Dual Power	£4.50	£5.17

Please add £1.00 p&p

EPROMS

	ex VAT	inc VAT
2764	£8.00	£9.20
27128	£22.00	£25.30

Please add £1.00 p&p

What the competition hasn't been waiting for.

Latest version of Forth for the BBC
(Is not rehased Forth 79 Code)

Unique Stack Display Utility



16k Eprom type 27128

Multi-tasking operating system
for Real-Time use.

Here's the Forth Eprom for the BBC Micro that makes all others out of date.

It's Multi-Forth 83 from David Husband who has built his reputation for Quality Forth products with his ZX81-Forth ROM, Spectrum Forth-I/O Cartridge and now New Multi-Forth 83 for the BBC Micro. This is not rehased Forth 79 Code, but a completely new version of the Forth 83 Standard. It's unique in that it Multi-tasks, and therefore the user can have a number of Forth programs executing simultaneously and transparently of each other.

Multi-Forth 83 sits in the sideways ROM area of the BBC along with any other ROMs in use. It is compatible with the MOS, and specially vectored to enable a system to be reconfigured. It contains a Standard 6502 Assembler, a Standard Screen Editor, and a Unique Stack Display Utility.

With this Forth, David Husband has provided the BBC Micro with capabilities never before realised. And being 16K rather than 8K is twice the size of other versions. Multi-Forth 83 is supplied with an

extensive Manual (170 pages plus) and at £40+VAT it is superb value.

Order it using the coupon adding £2.30 p&p (£5 for Europe, £10 outside) or if you want more information, tick that box instead. Either way, it will put you one step ahead of the competition.

Please send me Multi-Forth 83 for BBC Micro. £40+VAT. De-luxe System inc. Disc £80+VAT. Cheques to Skywave Software Readers' A/C (or enter Visa No.)

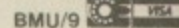

Please send me more information:

- Multi-Forth 83
- ZX81-Forth ROM
- Spectrum Forth-I/O Cartridge

Name _____
Address _____
Post code _____



SUBJECT TO AVAILABILITY. FOR I.O.O SONWARDS.
Send to Skywave Software, 73 Curzon Road, Bournemouth,
BH1 4PW, Dorset, England. Tel: (0202) 302385

MULTI-FORTH 83 FOR THE BBC MICRO

BY UDM

CPL

e

sity

00

inc VAT
£13.80
£17.25inc VAT
£15.00
£20.00inc VAT
£9.77
£4.02
£13.80
£5.17inc VAT
£9.20
£25.30n
Dr.

be 27128

g system

b value.
ope, £10
l. Either

BO+VAT.

VISA

Information:

tridge

VE

RE

RO

From Page 140

frequency measurement could be incorporated into this program to snatch a single note. This might produce better results when using an instrument to input the tune.

The program could also be altered to allow editing of the tune once it has been entered, and you could get it to plot out the tune as it is played.

You could even modify it so that you

dispense with the frequency measuring part and enter a tune note by note from the keyboard.

For those interested in tuning, how about writing a program where the difference between your note and what you are aiming at is represented as a variable length line or other graphical means?

Like most Body Build articles I have given you the tools for the job – it is now up to you. See you next month.

THE BEEB BODY BUILDING COURSE

```

10 REM AUTOMATIC MUSIC PLOTTER
20 REM By Mike Cook
30 RX=24
40 SMX=202
50 LASTX=1000
60 LZ=0
70 DIM PITCH$(RX),TX(RX),REC$(1,SM
X),CODEX-30
80 FOR OCTIVEX=0 TO 2
90 RESTORE 1170
100 DX=OCTIVEX*8
110 FOR BX=1 TO RX/3
120 READ PITCH$(BX+DX)
130 READ TX(BX+DX)
140 IF OCTIVEX=0 THEN TX(BX+DX)=TX(
BX+DX)/2
150 IF OCTIVEX=2 THEN TX(BX+DX)=TX(
BX+DX)*2
160 NEXT
170 NEXT
180 REM ADJUST FREQUENCY THRESHOLD
190 FOR AX=1 TO RX-1
200 TX(AX)=TX(AX)+((TX(AX+1)-TX(AX)
)/2)
210 NEXT
220 TX(0)=TX(1)-50
230 VDU 23,240,0,0,0,0,0,0,254,0
240 VDU 23,241,3,2,2,2,2,58,124,56
250 VDU 23,242,2,2,2,2,2,58,124,56
260 VDU 23,243,2,2,2,2,2,58,124,57
270 VDU 23,244,2,2,2,2,2,58,68,56
280 VDU 23,245,0,0,0,0,0,56,68,56
290 VDU 23,246,2,2,2,2,2,58,68,57
300 FOR AX=0 TO 3 STEP 3
310 PX=CODEX
320 [
330 OPT AX
340 .FREQ
350 LDA #&A0
360 STA &FE6B
370 LDA #&FF
380 STA &FE68
390 STA &FE69
400 STA &FE64
410 STA &FE65
420 RTS
430 ]
440 NEXT
450 MODE1
460 PRINT"BEEB BODY BUILDING COURSE
"
470 PRINT"AUTOMATIC MUSIC PLOTTER"
480 PRINT"By Mike Cook"
490 PRINT
500 PRINT"Using the user port to in
put sound"
510 PRINT
520 PRINT"You can terminate the seq
uence with"
530 PRINT"the space bar"
540 REPEAT
550 PRINT
560 NX=1
570 INPUT"INPUT SEQUENCE LENGTH",SL
X
580 SLX=SLX+1
590 IF SLX>SMX THEN PRINT"MAXIMUM "
;SMX-1:GOTO 570
600 CALL FREQ
610 GCOL 0,3
620 CLS
630 YX=0
640 PROC_LINES(256)
650 REPEAT
660 F=INT((&FFFF-(?&FE68+?&FE69*256
))/0.064)
670 CALL FREQ
680 TIME=0
690 PRINT TAB(0,13);"FREQUENCY IS "
;F;" Hz";SPC(8)
700 REM SERCH FOR NOTE
710 BX=-1
720 REPEAT
730 BX=BX+1
740 UNTIL TX(BX)>F OR BX=RX
750 PRINT "NOTE IS ";PITCH$(BX)
760 IF LASTX=BX THEN LX=LX+1 ELSE P
ROC_NOTE(LASTX,LX):LASTX=BX
770 IF LX=8 THEN PROC_NOTE(LASTX,8)
:LX=1
780 IF INKEY(-99) THEN SLX=NX
790 REPEAT:UNTIL TIME>6
800 UNTIL NX=SLX
810 *FX21,0
820 REPEAT
830 PROC_PLAY
840 PRINT TAB(0,27);"Press RETURN f
or a new sequence"
850 PRINT"Any other key to repeat t
une!"
860 AX=GET
870 UNTIL AX=13
880 UNTIL FALSE
890 DEF PROC_NOTE(BX,LX)
900 IF BX=0 THEN ENDPROC
910 REC$(0,NX)=BX
920 REC$(1,NX)=LX
930 NX=NX+1
940 PLACEX=192+BX*8
950 IF LX=5 THEN LX=6
960 IF LX=7 OR LX=8 THEN LX=5
970 VDU 5
980 MOVE YX,PLACEX
990 VDU 18,0,0,240,8,18,0,1,240+LX,
4
1000 YX=YX+40
1010 IF YX>1280 THEN CLS:GCOL0,3:PRO
C_LINES(256):YX=0
1020 ENDPROC
1030 DATA "C",261.6256,"D",293.6648,
"E",329.6276
1040 DEF PROC_LINES(YX)
1050 FOR AX=1 TO 5
1060 MOVE 0,YX
1070 DRAW 1280,YX
1080 YX=YX+16
1090 NEXT
1100 ENDPROC
1110 DEF PROC_PLAY
1120 FOR AX=1 TO SLX-1
1130 SOUND 1,-9,REC$(0,AX)*8+5,REC$(
1,AX)
1140 SOUND 1,0,88,1
1150 NEXT
1160 ENDPROC
1170 DATA "C",261.6256,"D",293.6648
1180 DATA "E",329.6276,"F",349.2282
1190 DATA "B",391.9954,"A",440.000
1200 DATA "B",493.8833,"C",523.2511

```

Listing IV

Make light work of it

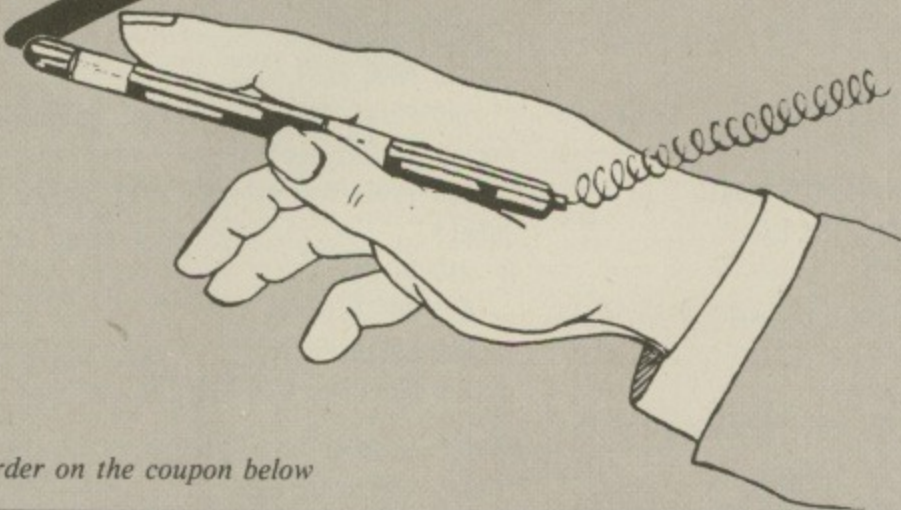

Order on the coupon below

USING a lightpen really DOES make light work of entering data into your BBC Micro.

Painting on the screen or selecting options comes naturally with *The Micro User* lightpen.

Children in particular find it easy to communicate with a micro this way.

With our ready-assembled lightpen comes full details of how to use it in your own programs PLUS three pieces of software to get you started:

- **Pentest** – to set things up for your own micro.

- **Pendraw** – an enthralling painting program.

- **Penbell** – an entertaining musical diversion.

All in all, *The Micro User* lightpen is a really versatile add-on for your BBC Micro, with lots of possibilities.

We'll be publishing lots of interesting applications for the lightpen in forthcoming editions of *Micro User*. But if you simply can't wait, incorporating a lightpen in your own programs is simplicity itself.

And when you've done it, why not send us the results – you could become one of our authors!

What the Beeb Body Building packs contain

Upgrade your BBC Micro with these Beeb Body Building Packs.

- **Packs 1 and 2:** These packs let you safely and simply interface your micro to the outside world.

- **Pack 3:** Give your Micro data-processing muscle by building a dual cassette system.

- **Packs 4 and 5:** Control mains equipment in complete electrical isolation. Pack 4 is rated at 4 amps, pack 5 at 10 amps.

- **Pack 6:** All the components for the Micro User light pen.

- **Pack 7:** Experiments to investigate pendulum behaviour and capacitor discharge.

- **Pack 8:** A versatile sound to pattern converter with many applications.

- **Pack 9:** Remember all those vital appointments with the help of this real time clock.

- **Pack 10:** A high speed A/D with many applications. For instance, turn your microcomputer into an oscilloscope!

- **Pack 11:** A pulse rate monitor. Ideal for keep-fit fanatics and experimenters alike.

- **Packs 12 and 13:** Components to control stepping motors in two different ways. Pack 12 uses the micro to control the stepping sequence. Pack 13 uses a dedicated chip.

- **Pack 14:** Turn your micro into a communications terminal by building an acoustically coupled modem. (Handset retainer not included.)

- **Pack 15:** Add the tremendous power of 4 extra User Ports to your BBC Micro.

- **Pack 16:** The ribbon cable and socket needed for pack 15.

Also available are a full-assembled light pen, sound-to-pattern converter, real time clock and pulse monitor. For a small extra charge constructors who run into difficulty assembling pack 8 can send it in for testing. It will be returned fully operational.

YOUR ORDER FORM

for the Beeb Body Building packs

Please send me:	Described in issue	No.	Amount
Pack 1 @ £9.95	July 1983 page 83	<input type="checkbox"/>	£
Pack 2 @ £9.95	July 1983 page 83	<input type="checkbox"/>	£
Pack 3 @ £9.95	August 1983 page 85	<input type="checkbox"/>	£
Pack 4 @ £9.95	Sept 1983 page 91	<input type="checkbox"/>	£
Pack 5 @ £12.95	Sept 1983 page 91	<input type="checkbox"/>	£
Pack 6 @ £13.65	October 1983 page 69	<input type="checkbox"/>	£
Pack 7 @ £15.50	November 1983 page 71	<input type="checkbox"/>	£
Pack 8 @ £16.55	December 1983 page 95	<input type="checkbox"/>	£
Pack 9 @ £28.50	February 1984 page 123	<input type="checkbox"/>	£
Pack 10 @ £24.95	March 1984 page 132	<input type="checkbox"/>	£
Pack 11 @ £19.00	April 1984 page 118	<input type="checkbox"/>	£
Pack 12 @ £24.95	May 1984 page 148	<input type="checkbox"/>	£
Pack 13 @ £29.45	May 1984 page 148	<input type="checkbox"/>	£
Pack 14 @ £59.95	July 1984 page 115	<input type="checkbox"/>	£
Pack 15 @ £44.95	August 1984 page 117	<input type="checkbox"/>	£
Pack 16 @ £8.25	August 1984 page 117	<input type="checkbox"/>	£
Assembled light pen @ £18.35		<input type="checkbox"/>	£
Assembled sound to pattern converter @ £22.30		<input type="checkbox"/>	£
Assembled real time clock £31.00		<input type="checkbox"/>	£
Testing sound to pattern converter @ £9.70		<input type="checkbox"/>	£
Assembled pulse monitor @ £25.50		<input type="checkbox"/>	£

Postage and packing All prices include VAT Plus post and packing £1.00
 FREE if more than one pack is ordered Cheque to be made payable to Database Publications Total £

Name

Address

POST TO: BBB Packs, Micro User, Europa House, 68 Chester Road, Hazel Grove, Stockport SK7 5NY.

Please allow up to 28 days for delivery

4

Emmanuel St.

Our new Personal Computer Centre specializing in the BBC Micro with complete support

we know computers

Business & Professional
Tel: 0223 65335/4

Home & Educational
Tel: 0223 358264

Cambridge Computer Store

1&4 Emmanuel Street, Cambridge

Expandable console for the BBC Micro

As supplied to Universities, Colleges, Schools, Business and Home Users.

Not just a monitor/tv stand but an expansion console which gives your micro the professional look. Protects and encloses your micro with room for disc drives and 2nd. processor or teletext adapter etc., all untidy connecting wires safely out of sight within the console. Made of light yet strong aluminium with a textured finish in matching BBC colour. Available now a bolt on extra module to the console for further expansion options. YES this console will grow with your needs. Basic BBC console as shown £44.99 + £4 carriage.

SPECIAL TORCH MODEL AVAILABLE: £46.99 + £4 carriage

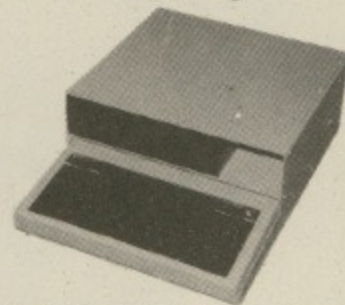

Bolt on expansion module £14.99 + £2 p&p

Matching Printer Stand, can double for VDU Stand over the micro - only £14.99 + £2 carriage

ELECTRON CONSOLE

The console will house the ELECTRON and will safely support the expansion interfaces which will plug into the rear of the micro and will support the VDU at eye level. Tidies up all wiring between the micro, cassette and VDU. The console stores the cassette and tapes and will allow space for drives at a later date.

Electron console as shown £34.99 + £3 p&p

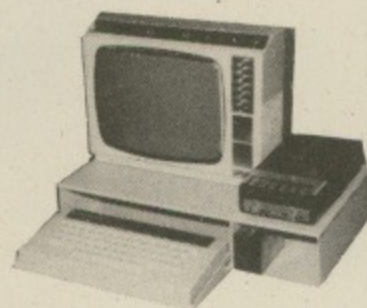

Mail order only - viewing by appointment

Please add 15% VAT.

For further information or send cheque to:

Silent COMPUTERS

27 WYCOMBE ROAD, LONDON N17 9XN.
TEL: 01-801 3014 (24 Hr Ansaphone)

Datapen

BBC Lightpen Programs

Datapen



BEEB PEN DRAWING PROGRAM

A comprehensive Mode 2 colour drawing program allowing plot commands, painting, circles, text, character defining, saving and loading to tape or disc, all to be selected and used with the lightpen.

PRICE £11.95 Introductory Offer £9.95

Teletext
Display
CREATOR

TELETEXT DISPLAY CREATOR/EDITOR

Allows the busy programmer to quickly create Mode 7 colour graphics and test screens for combination into his or her own programs. Movable on screen menu allows use of complete screen for graphics. Full instructions and a discussion on teletext features are provided. **PRICE £9.95 Introductory Offer £7.95**



BRITAIN

The first in a series of educational Geography and Geology programs. Britain comes complete with three sets of tests, and these may be very easily changed by adding DATA statements in the Basic program. Full instructions and grid map supplied.

PRICE £6.95 Introductory Offer £5.95

SUPERIOR PERFORMANCE

- Insensitive to ambient lighting
- Responds to different colours
- Program accessible LED lamp readout
- Switch for program control



SUPERIOR PROGRAMS

- Tape storage of your work
- Good documentation
- User routines provided on tape and on printout

The Datapen Lightpen itself comes complete with handbook, software on tape including two drawing programs and a printed listing showing useful routines.

PRICE £25.00

Two drawing programs, SKETCH and SHAPE-CREATE are included with the lightpen and the programs shown above may be ordered additionally, or separately as required.

All prices above include VAT, postage and packing.

Please send your cheque/P.O. to:-

Dept. MU2 Datapen Microtechnology Ltd., Kingsclere Road, Overton, Hants. RG25 3JB

SINGLE BOARD 6809 2nd PROCESSOR FOR THE BBC MICRO.

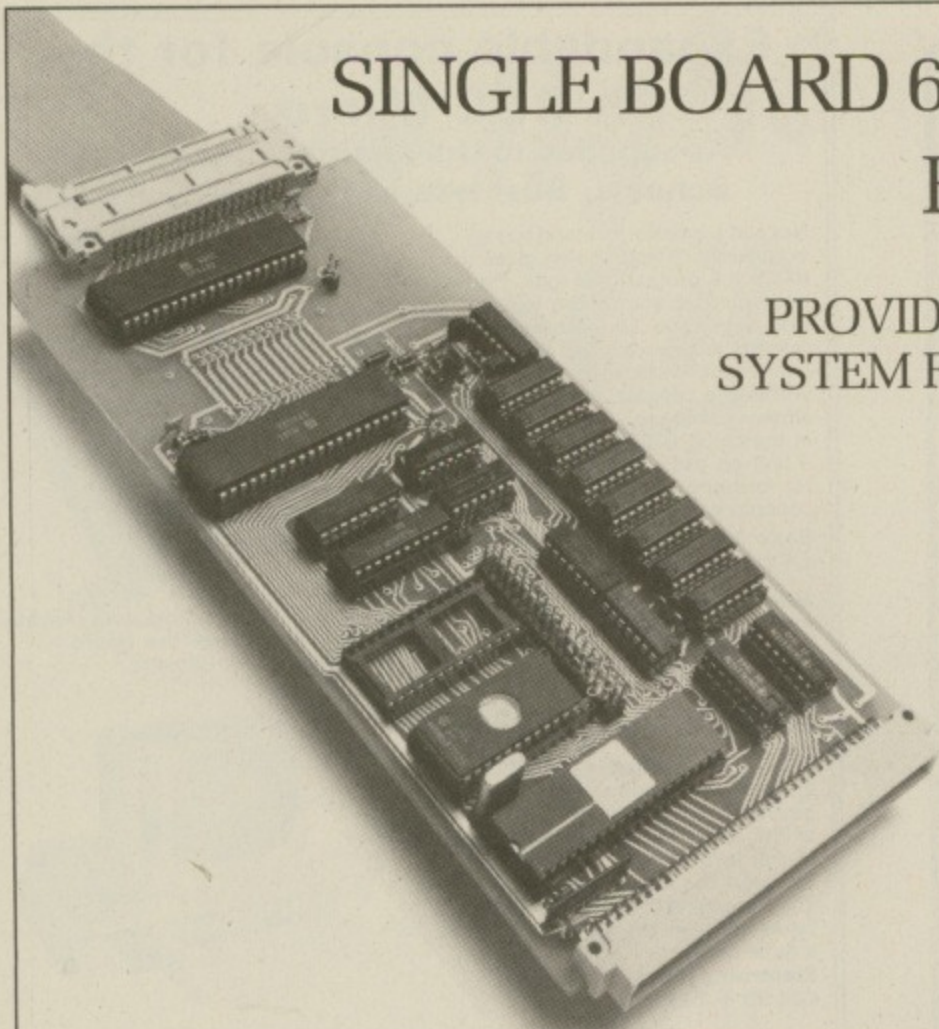

PROVIDES A LOW-COST DEVELOPMENT
SYSTEM FOR INDUSTRIAL APPLICATIONS.

- Sits inside the BBC or plugs into an extension rack
- Enables standard FLEX format discs to run on BBC.
- Supports High Level Language Compilers
- Cross Assemblers and Disassemblers for most micros
- Connects directly on to the tube
- 64k DRAM on board
- Two 28 pin byte wide memory sockets
- Acorn Bus compatible DIN 41612 Bus interface
- Also available as a single board controller

One of an exciting new range
of Eurocards from:

GMS

44a Hobson Street
Cambridge CB1 1NL
Tel. 0223 324141

Cambridge
Microprocessor
Systems Limited

STATA COM - STATA COM - STATA COM

Disk Drives for the Micro user —

Statacom Distribution Ltd, are main
distributors for Datafax Disk Drives
in the U.K.

Whatever your needs . . . talk to us.

An amazing range of top quality
drives, supplied with leads, cables
and utility disks from a single 100K
(200K flipable disk) with or without
power supply unit, right
through to a dual 400K,
double sided unit (800K
double density) with power
supply unit.

We also distribute
a complete range
of 5 1/4" disk drives.

All finished in an
attractive metal
case to match
your BBC



STATA COM DISTRIBUTION LTD, 15-17 CHEAM ROAD, SUTTON, SURREY SM1 1SW 01-661 2266

Number Signs listing

From Page 71

```

10 MODE 7
15 VDU23;8202;0;0;0;
20 PROCinit
30 PROCinstr
40 PROCTune
50 PROCname
55 REPEAT
56 PROCinit
60 MODE 2
65 VDU23;8202;0;0;0;
70 PROCcalc
80 PROCscreen
90 PROCgame
100 MODE 7
105 VDU23;8202;0;0;0;
110 PROCscore
120 UNTIL 0
130 DEFPROCinit
140 VDU 23,224,0,1,2,4,8,80,80,32,2
3,225,0,64,34,20,24,16,40,68
150 VDU 23,230,24,24,24,255,255,24,
24,24,23,231,0,0,0,255,255,0,0,0,23,2
32,195,231,126,60,60,126,231,195,23,2
33,24,24,0,255,255,0,24,24,23,234,0,1
26,126,0,0,126,126,0
160 SC=0:XX=6:YZ=16:X=0:SY=26:
R$="":delay=6250:BX=564:BY=457:level=
8
170 ENDPROC
180 DEFPROCinstr
190 PRINTTAB(10,1);CHR$(141);CHR$13
1"NUMBER SIGNS"TAB(10,2);CHR$(141);CH
R$134"NUMBER SIGNS"
200 PRINTTAB(0,7);CHR$134"Hello,"CH
R$131"the object of this game is for
"CHR$131"you to type in the correct
sign that "CHR$131"goes into the bo

```

x that will appear on "CHR\$131"the s
creen when you are asked."

```

210 PRINT"CHR$131"On the keyboard
of the computer: "'CHR$134"
*"CHR$131"means 'multiplies'
215 PRINTCHR$134" /"CHR$13
1"means 'divide'"CHR$134" -
"CHR$131"means 'take away'"CHR$134"
+"CHR$131"means 'add'"
220 PRINTTAB(10,20);CHR$(141);CHR$1
34"GOOD-LUCK"TAB(10,21);CHR$(141);CHR
$131"GOOD-LUCK"
230 *FX 15,0
240 PRINTTAB(5,22);CHR$131"Press"CH
R$134"any key"CHR$131"to continue....
":A$=GET$
250 ENDPROC
260 DEFPROCname
280 CLS:PRINTTAB(10,1);CHR$(141);CH
R$131"NUMBER SIGNS"TAB(10,2);CHR$(141
);CHR$134"NUMBER SIGNS"
290 SOUND -1,241,0,0:SOUND -1,192,0
,0:SOUND -1,290,0,0:SOUND -1,223,0,0
300 PRINTTAB(6,9)CHR$131"Please ent
er your name"TAB(8,10)CHR$131"then pr
ess Return"
305 PRINT TAB(11,12)CHR$(145)"<,,,
,,,,,1"TAB(11,13);CHR$(145);"5
j"TAB(11,14);CHR$(145);"-,,,,,
,,,
310 PROCdelay
320 A$=FNinput("Z","A",7)
330 PRINTTAB((36-(LEN(TE$)))/2,17);
TE$TAB(9,19)CHR$136"I LIKE THAT NAME"
340*FX15,0
350 PRINTTAB(5,22)CHR$131"Press"CHR
$134"any key"CHR$131"to continue...."

```

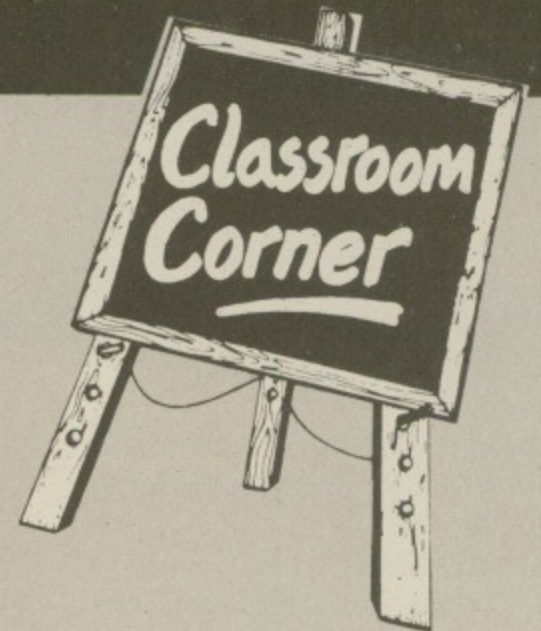

```

:A$=GET$
360 ENDPROC
370 DEFPROCTune
380 FOR data=1 TO 7
390 READ pitch,duration
400 FOR notes=1 TO 3
410 SOUND notes,-15,pitch,duration
420 NEXT
430 NEXT
440 DATA 117,5,117,5,121,5,117,5,10
9,5,101,10,149,5
450 PROCdelay
460 ENDPROC
470 DEFPROCscreen
480 GCOL 0,5
490 MOVE 0,0:MOVE 0,100:PLOT 85,100
,0:MOVE 1180,0:MOVE 1280,0:PLOT 85,12
80,100:MOVE 0,900:MOVE 0,1024:PLOT 85
,100,1024:MOVE 1280,900:MOVE 1280,102
4:PLOT 85,1180,1024:MOVE 0,0:MOVE 0,1
024:PLOT 85,40,0:PLOT 85,40,1024
500 MOVE 1280,0:MOVE 1280,1024:PLOT
85,1230,0:PLOT 85,1230,1024:MOVE 0,1
024:MOVE 1280,1024:PLOT 85,0,980:PLOT
85,1280,980:MOVE 0,0:MOVE 1280,0:PLO
T 85,0,40:PLOT 85,1280,40
510 MOVE 480,980:MOVE 770,980:PLOT
85,480,900:PLDT 85,770,900:GCOL 0,0:M
OVE 520,900:MOVE 480,900:PLOT 85,480,
940:MOVE 730,900:MOVE 770,900:PLOT 85
,770,940:GCOL 0,7
520 MOVE 60,40:DRAW 40,60:DRAW 40,9
50:DRAW 70,980:DRAW 480,980:DRAW 480,
940:DRAW 520,900:DRAW 730,900:DRAW 77
0,940:DRAW 770,980
530 DRAW 1200,980:DRAW 1230,950:DRA
W1230,60:DRAW 1210,40:DRAW 60,40
540 VDU 5:MOVE 510,975:GCOL 0,4:PRI
NT"SIGN":VDU 4
550 GCOL 0,7:MOVE 315,128:DRAW 315,
224:DRAW 960,224:DRAW 960,128:DRAW 31
5,128
560 MOVE 362,450:DRAW 362,547:DRAW
904,547:DRAW 904,450:DRAW 362,450:MOV

```

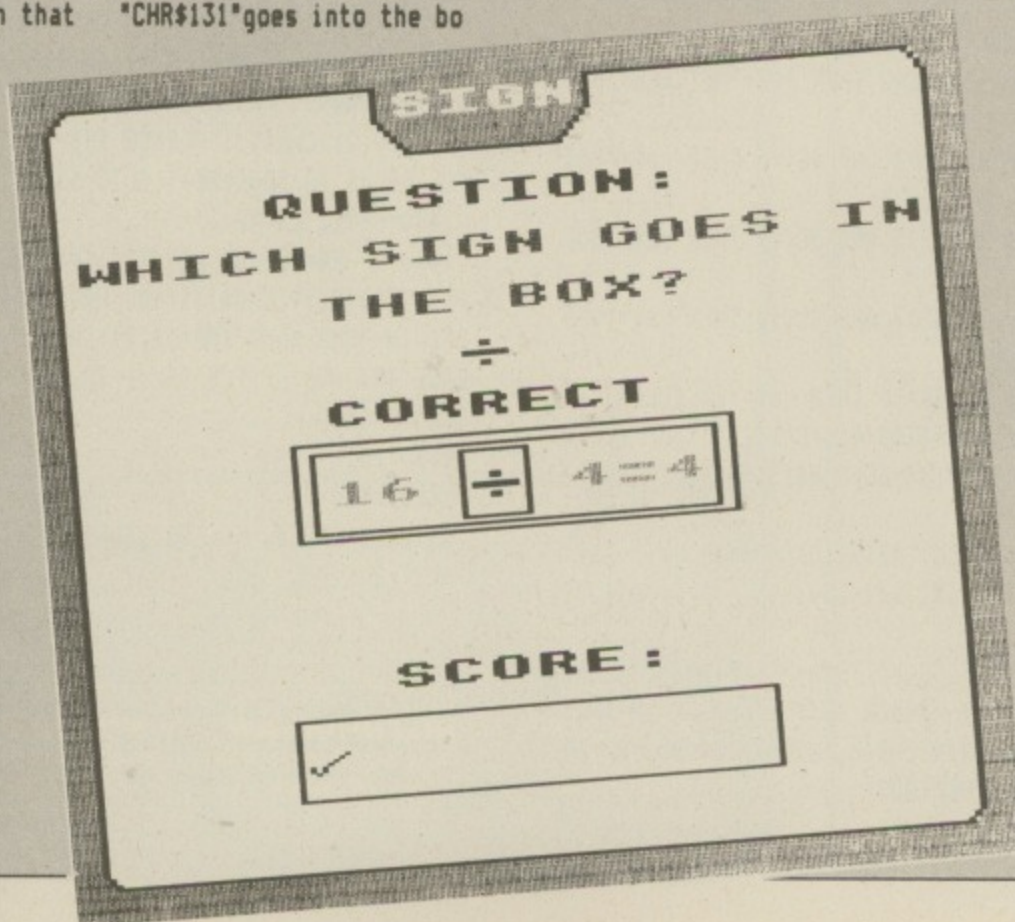

Number Signs listing

From Page 147

```

E 342,440:DRAW 342,557:DRAW 928,557:D
RAW 928,440:DRAW 342,440
570 ENDPROC
580 DEFPROCbox (C%)
590 GCOL 0,C%
600 MOVE BX,BY:DRAW BX,BY+80:DRAW B
X+84,BY+80:DRAW BX+84,BY:DRAW BX,BY
610 ENDPROC
620 DEFPROCcalc
630 A=RND(level):B=RND(level):CH=RN
D(4)
640 ON CH GOTO 650,670,720,740
650 IF A=2 AND B=2 THEN GOTO 630 EL
SE C=A+B:A%=CHR$(230):CH%="+ "
660 GOTO 760
670 IF A>B THEN C=A-B
680 IF B>A AND B<>A THEN GOTO 630
690 IF B=A THEN GOTO 630
700 A%=CHR$(231):CH%="- "
710 GOTO 760
720 IF A=1 OR B=1 OR A=2 AND B=2 TH
EN GOTO 630 ELSE C=A*B:A%=CHR$(232):C
H%="*"
730 GOTO 760
740 IF B=1 THEN GOTO 630 ELSE IF A/
B=INT(A/B) THEN:C=A*B:A%=C:C=A/B ELSE
GOTO 630
750 A%=CHR$(233):CH%="/ "
760 IF A>=10 THEN X=1 ELSE X=0
770 X%=6:IF B>=10 OR C>=10 THEN:X%=
X%-1:BX=500 ELSE BX=564
780 IF A/B=C AND A-B=C THEN GOTO 63
0
790 ENDPROC
800 DEFPROCgame
810 COLOUR 3:PRINTTAB(7,23);"SCORE:
"
820 FOR T=1 TO 10
830 TL%="Test for "+TE%
840 PROCbox(0):PROCcalc:PROCbox(7)
850 PRINTTAB(6,16);" ":COLOUR 1:IF
X=1 THEN:PRINTTAB(X%,Y%);A ELSE PRINT
TAB(X%+1,Y%);A
860 PRINTTAB(X%+5,Y%);B;CHR$(234);C
870 COLOUR 3:PRINTTAB(5,5);"QUESTIO
N:";:COLOUR 4:PRINT;T:PRINTTAB(2,29);
TL%;COLOUR 6:PRINTTAB(1,7);"WHICH SIG
N GOES IN"TAB(6,9);"THE BOX?"
880 *FX 15,0
890 D%=GET$:IF D%=":" OR D%=";" THE
N:COLOUR 12:SOUND 2,-15,88,8:SOUND 2,
-15,77,7:PRINTTAB(4,20);"PRESS SHIFT"
TAB(4,21);"AND THE KEY":FOR D=1 TO de
lay:NEXT:PRINTTAB(4,20);SPC(11)TAB(4,
21);SPC(12):COLOUR 7:GOTO 880
900 F=INSTR("*/-+",D%)

```

```

910 IF F=0 THEN GOTO 890
920 IF F=4 THEN P%=CHR$(230)
930 IF F=3 THEN P%=CHR$(231)
940 IF F=1 THEN P%=CHR$(232)
950 IF F=2 THEN P%=CHR$(233)
960 FOR DL=1 TO 2000:NEXT:PRINT TAB
(9,11);P%
970 IF D%=CH% THEN:M%="CORRECT":p=-
10:char=224:s=1 ELSE M%="WRONG":p=-2
:char=225:s=0
980 PROCmessage(M%,p,char,s)
990 NEXT
1000 ENDPROC
1010 DEFPROCmessage(N%,P,CHAR,S)
1020 *FX 15,0
1030 COLOUR 3:PRINTTAB(SX,SY);CHR$(C
HAR)
1040 SX=SX+1:SC=SC+S
1050 FOR sound=-15 TO 1 STEP 5
1060 SOUND 2,sound,sound*P,2:SOUND 3
,sound,sound*P,2:SOUND 1,sound,sound*
P,2
1070 NEXT
1080 IF X=1 THEN X%=9 ELSE X%=X%+3
1090 COLOUR 7:PRINTTAB(X%,Y%);P%:*FX
15,0
1100 COLOUR S+14:Z%=(19-(LEN(N%)))/2
:PRINTTAB(Z%,13);N%
1110 IF S=0 THEN PRINTTAB(2,20);"THE
ANSWER IS ";A%
1120 PROCdelay:PRINTTAB(Z%,13);SPC(L
EN(N%))TAB(2,20);SPC(16)
1130 PROCbox(0):PRINTTAB(7,16);SPC(7
)TAB(9,11);" "
1140 ENDPROC
1150 DEFPROCscore
1160 PRINTTAB(10,1)CHR$(141)CHR$131"
NUMBER SIGNS"TAB(10,2)CHR$(141)CHR$13
4"NUMBER SIGNS"
1170 IF SC<=2 THEN re%="NOT VERY GOOD"
1180 IF SC>2 AND SC<=5 THEN re%="FAI
R"
1190 IF SC>5 AND SC<=7 THEN re%="GOOD"
1200 IF SC>7 AND SC<10 THEN re%="VER
Y GOOD"
1210 IF SC=10 THEN re%="EXCELLENT"
1220 PRINTTAB(4,8)CHR$131"Your score
was"CHR$134;SC;CHR$131"out of"CHR$13
4"10"
1230 PRINTTAB(9,10)CHR$134"This was"
1240 PRINTTAB((35-(LEN(re%)))/2,12);
re%
1250 IF SC<=5 THEN PRINTTAB(6,14)CHR
$131"TRY HARDER NEXT TIME"
1260 PRINTTAB(6,16)CHR$134"DO YOU WA
NT ANOTHER 60?"

```

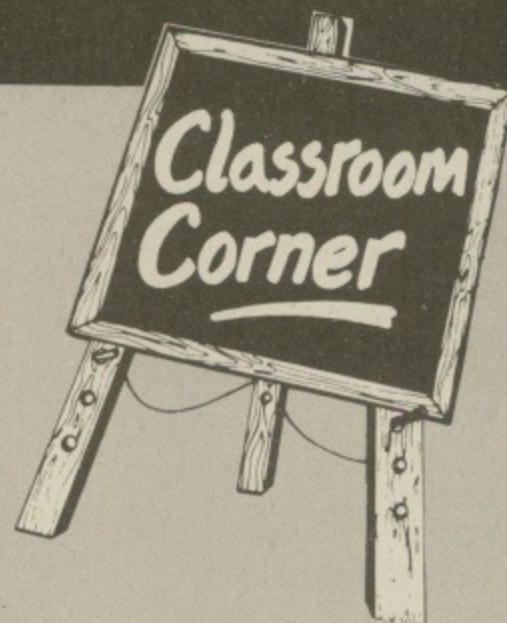

```

1270 PRINTTAB(17,19);:G%=GET$:IF G%=
"Y" THEN:PRINTG%:ENDPROC ELSE:PRINTTA
B(12,19);CHR$(141);"BYE-BYE"TAB(12,20
);CHR$(141);"BYE BYE":END
1280 ENDPROC
1290 DEFFNinput(HI%,LO%,NU)
1300 LOCAL HI,LO,CO,EN,DE
1310 LOCAL RE,EN%
1320 *FX15,0
1321 PRINTTAB(15,13);SPC(7)TAB(15,15
);SPC(7)TAB(2,19);SPC(40);TAB(10,21);
SPC(40):DE=127:RE=13:HI=ASC(HI%):LO=A
SC(LO%):CO=0:TE%="":REPEAT:REPEAT
1330 OK=FALSE:PRINTTAB(CO+15,13);:EN
%=GET%:*FX 15,0
1340 EN=ASC(EN%)
1350 IF EN=32 THEN PRINT " ";:CO=CO+1
1360 IF EN>=LO AND EN<=HI THEN OK=TR
UE
1370 UNTIL OK OR EN=DE OR EN=RE
1380 CO=CO+1:IF EN=DE AND CO>=1 THEN
:CO=CO-2
1390 IF EN=RE THEN CO=CO-1
1400 TE%=TE%+EN%
1410 IF EN<>RE THEN PRINTEN%;
1420 IF CO=NU THEN:PRINTTAB(2,19)CHR
$131"I CANNOT REMEMBER A NAME SO LONG
"TAB(10,21)CHR$131"PLEASE TRY AGAIN":
FOR DEL=1 TO 3000:NEXT:GOTO 1320
1430 UNTIL EN=RE
1440 IF EN=RE AND LEN(TE%)<=1 THEN :
PRINTTAB(2,19)CHR$131"YOU HAVE NOT TY
PED IN YOUR NAME"TAB(10,21)CHR$131"PL
EASE TRY AGAIN":FOR DEL=1 TO 3000:NEX
T:GOTO 1320
1450 PRINT
1460 =TE%
1470 DEFPROCdelay:FOR DEL=1 TO delay
:NEXT:ENDPROC

```

This listing is included in this month's cassette tape offer. See order form on Page 193.

wildings

COMPUTER CENTRE

EPSON PRINTERS

RX80 £239.95

RX80F/T £269.95

FX80 £375.00

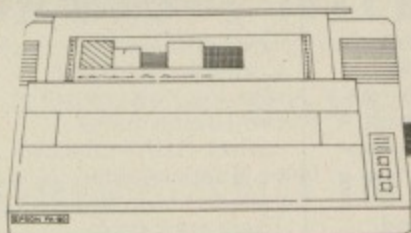

The superb range of Epson printers are even better value than ever at these super new low prices.

SHINWA CP80

- * 80 column and self test
- * Friction and tractor feed
- * Bi directional printing
- * Hi res graphics
- * Many more features

COSMOS 80

Limited quantities of this printer are available at the amazing low price of

**** £199.95 ****

WILDINGS
LOW PRICE

£229.95

Specification is the same as the Shinwa.

PACE DISK DRIVES

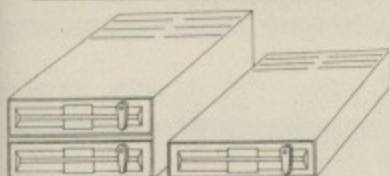

The extensive range of Pace disk drives are fully compatible with the double density op. systems which are now becoming available.

With Wildings super low prices and a drive to suit every purpose you need look no further.

PSD1 (100K single) 40T	£169.95	PDD1 (200K double) 40T	£334.95
PSD2 (200K single) 40T	£239.95	PDD2 (400K double) 40T	£469.95
PSD3 (400K single) 40/80T	£279.95	PDD3 (800K double) 40/80T	£555.95
PSD4 (400K single) 80T	£244.95	PDD4 (800K double) 80T	£479.95
PSD5 (200K single) 40/80T	£254.95	PDD5 (400K double) 40/80T	£499.95

All drives include formatting disk and manual.

Various disk operating systems in stock. Please phone or call for details.

MONITORS

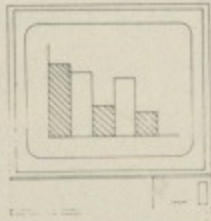
MICROVITEC	SANYO	CD3125N
14" Cub colour monitor inc. VAT £219.95		14" colour monitor inc. leads for connection to the BBC Micro. Few only at £199.95
14" Cub colour monitor with sound facility inc. VAT £239.95		

MAIL ORDER Please address all postal and telephone enquiries to the Wigan branch.

Postage - Monitors, Drives, Printers - £5.00. Prices inc. VAT.

PRICES CORRECT AT TIME OF GOING TO PRESS BUT SUBJECT TO CHANGE WITHOUT NOTICE E & O E

WIGAN

11 Mesnes St, Wigan
Lancs. WN1 1QP
Tel: Wigan (0942) 44382
Closed Wed.

BOLTON

23 Deansgate, Bolton
Gr. Manchester BL1 1HH
Tel: (0204) 33512
Closed Wed.

CHORLEY

68 Market St, Chorley
Lancs. PR7 2SE
Tel: Chorley (02572) 74224
Closed Wed.

PRESTON

49 Fishergate, Preston
Lancs. PR1 8BH
Tel: Preston (0772) 556250
Closed Thurs.

WARRINGTON

111 Bridge St, Warrington
Cheshire WA1 2AR
Tel: (0925) 38290
Closed Thurs.

STOCKPORT

1 Little Underbank, Stockport
Cheshire SK1 1LA
Tel: 061-480 3435
Closed Thurs.

DISK FILE

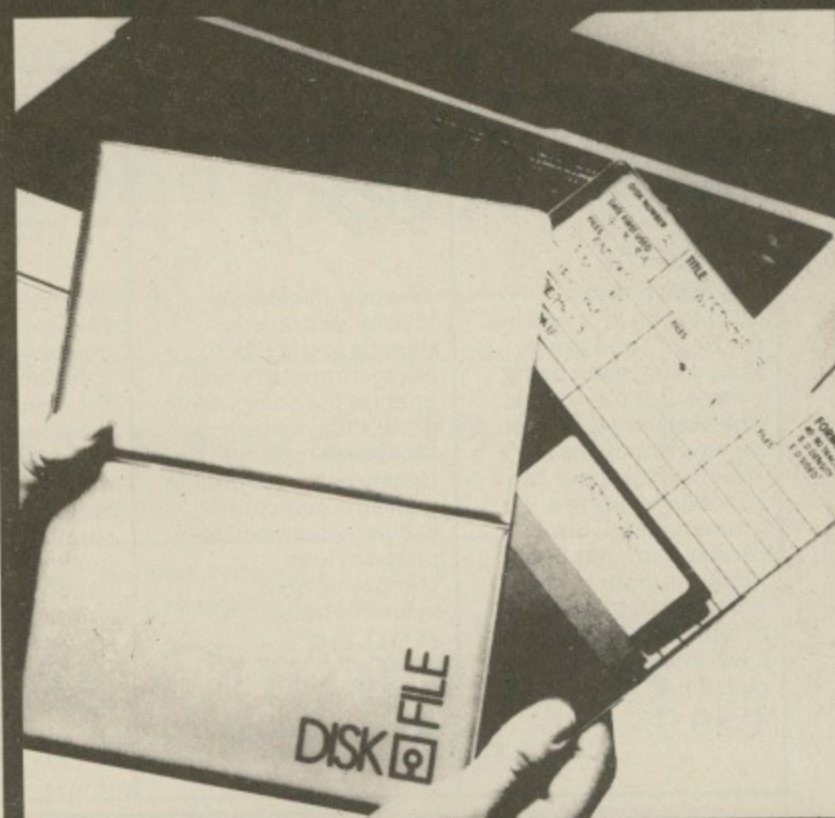

The Best Thing Next To Your Disk Drive

Proper care of your diskettes is essential to the well-being of your disk drives.

Dirt or grit on the diskette might wreck an important file and could mean expensive damage to the drive itself.

Storing your diskettes in a Personal Disk File protects them and creates an accessible and well organised library system too.

Each wallet is made from a strong but flexible vinyl to protect your valuable data with an individual index card with spaces for format, files and your disk to disk back-up record.

A special easel mechanism enables the Personal Disk File to stand for convenient access and the beige covers match the BBC.

The Personal Disk File comes complete with 10 inserts to hold 20 disks and their index cards.

Don't take chances, store your diskettes the right way now!

Direct by return of post from SOFTEACH or from good computer stores.

To SOFTEACH LIMITED, 25 College Road, Reading, Berkshire, RG6 1QE.

Please send me:

Personal Disk Files Complete with 10 inserts and 20 index cards at £9.95 plus £1.35 post & packing, total £11.30 each

Refill Kits Of 20 index cards at £1.95 each inclusive.

(Overseas should add 25% for additional surface mail)

I enclose a total remittance of £ _____ cheque/postal order payable to SOFTEACH LIMITED.

NAME _____

ADDRESS _____

MU8

ROBOTICS

ROBOT ARM

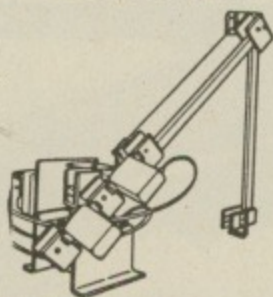

The Beasty arm mechanism is driven by the Beasty and three servos, the result being a three axis robot arm. The arm uses a hook to manipulate objects although a gripper can be made by using a further servo. This versatile arm has been designed with enthusiasts and schools in mind although where it will end is anyone's guess!

£39.95

THE BEASTY

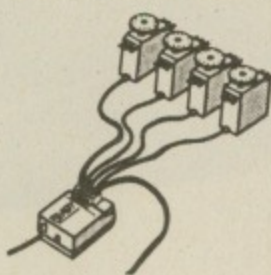

The popular Beasty interface connects directly to the BBC Microcomputer which enables the computer to accurately control up to four servo motors. The Beasty comes complete with all connection cables, a demonstration program and comprehensive instructions.

£29.95

Servos £14.50

VISION



The EV1 is an electronic camera that links to your computer. Using its own optical sensor, the camera quickly captures high quality images for visual display, printing and analysis. The EV1 is supplied with a high quality lens, a detailed handbook together with comprehensive software.

£129.95

MAINS CONTROL

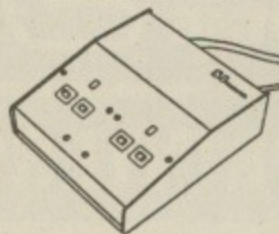

The SJR2 Mains Controller gives you safe, low-cost control of two 13amp mains outlets. Each outlet can be independently switched from Basic. There are lots of applications from security to home appliances, so put your Micro in control...

£34.50

CONTROL ROM



The Control ROM provides an extension to the BBC Machine for control applications. It's an essential tool for anyone teaching computer control technics, or who wants to use the computer in practical control applications. The process of sending signals to control devices is very crudely handled by most micros and the Control ROM changes this.

£44.85

Phone for further details All prices include VAT

COMMOTION

241 Green Street
Enfield EN3 7SJ
Tel: 01-804-1378

MAD MONTH SALE OF BBC DISC DRIVES

(ONE MONTH ONLY - FIRST COME, FIRST SERVED)

£50.00 OFF HITACHI 3" DISC DRIVES

Single Sided 3" Disc Drive normally £179.99 now £129.99

Double Sided 3" Disc Drive normally £179.99 now £129.99

Disc Drives are supplied C/W with all Cables, Utility Disc and Manual. Prices include VAT and postage.

Send cheque or P.O to:

**SPIDER SYSTEMS, WEB HOUSE, 29 ELMFIELD ROAD
STOCKPORT SK3 8SE**

Tel: 061-483 7682

EXTENDED (by H&B)
UNTIL 31st AUGUST
(while stocks last)

SPECIAL SUMMER OFFERS!!

— SAVE £80.00 —

**BBC MODEL B
CASSETTE PLAYER £399 inc VAT
5 ACORNSOFT TITLES**

— SAVE £50.00 —

DISC DRIVE AND INTERFACE FOR £229.95

(Acorn Disc Interface with 100K 40 track Disc Drive)

*Mail/telephone orders to Oldham address * £1,000 instant credit available * Carriage £4.25 per machine, UK mainland * Access/Barclaycard welcome * Prices correct at time of going to press E & O E

Home & Business Computers

THE NORTH'S LEADING COMPUTER SUPPLIERS

(Spectrum Group Member)

**54 Yorkshire Street
Oldham
Tel: 061-633 1608**

**73 Yorkshire Street
Rochdale
Tel: (Rochdale) 344654**

**59 Daisy Hill
Dewsbury
Tel: 0924 455300**

HIGH QUALITY COMPUTER DESKS AT HIGHLY COMPETITIVE PRICES.

THE ORGANISER DESK.

- Top shelf for monitor/printer.
- Large desk top area.
- Lower shelf for paper/book storage.
- Teak finish • On castors.
- Self assembly.
- Ample room in front of the shelf for you to sit comfortably.
- Assembled Dimensions: H.31" W.40¼" D.26"



Only **£59.95.**

THE APOLLO RANGE OF BUSINESS DESKS.

- 10 models available to suit leading computer systems. • Immediate delivery.
- Sturdy steel underframes.
- Scratch resistant surfaces.
- Lockable castors. • Prices from **£100.**

All are on display in our showroom and are available from us or dealers throughout the U.K. All prices include VAT and delivery.

For further details contact us at:

158 Camberwell Road, London SE5 0EE. Telephone: 01-701 8668.

Opus.
Opus Supplies Ltd.

Rollerball listing

From Page 133

```

10 REM *****
20 REM * ROLLERBALL *
30 REM * by *
40 REM * Geoff Turner *
50 REM * 1984 *
60 REM *****
70 *TV255
80 ON ERROR MODE 7
  :REPORT
  :PRINT " ";ERL
  :END
90 P%=&D00
100 [
110 OPT2
120 SEI
130 LDA#128
140 LDX#250
150 JSR&FFF4
160 STX&70
170 CLI
180 RTS
190 ]
200 MODE 7
210 PROCINIT1
220 PROCINIT2
230 PROCINSTRUCTIONS
240 MODE 2
250 VDU 5
260 PROCSCREEN
270 TIME =0
280 PROCMAINLOOP
290 PROCEND
300 CLG
310 MODE 7
320 PRINT TAB(5,5);CHR$(131);"YOU
  TOOK ";TZ;" SECONDS"
330 PRINT
340 IF TZ>200
  :C$="THAT WAS TERRIBLE !!!"
350 IF TZ<150
  :C$="THAT WAS A POOR ATTEMPT"
360 IF TZ<120
  :C$="THAT WAS QUITE GOOD"
370 IF TZ<80
  :C$="THAT WAS VERY GOOD"
380 IF TZ<40
  :C$="THAT WAS EXCELLENT"
390 IF TZ<20
  :C$="YOU CHEATED !!! "
400 PRINT TAB(5,7);CHR$(133);C$
410 PRINT
420 PRINT TAB(6,10);"PLAY AGAIN
  (Y/N) ?"
430 PROCMUSIC
440 *FX21,0
450 I$=INKEY$ (5)

```

The listings in this article are produced using a special formatter which breaks one program line over several lines of listing. When entering a line don't press Return until you come to the next line number. Full details of the formatter are in the July 1983 issue of *The Micro User*.

```

460 IF I$="Y" CLS
  :GOTO 220
470 IF I$<>"N"
  THEN 430
480 CLS
  :*FX11,32
490 END
500 DEF PROCSCREEN
510 VDU 23,1,0;0;0;0;
520 GCOL 0,2
530 IF CZ=3
  THEN VDU 19,2,0,0,0,0
540 XZ=0
  :YZ=0
  :AZ=1008
  :BZ=1000
550 REPEAT
560 IF XZ>400
  THEN GCOL 0,3
570 MOVE XZ,YZ
580 DRAW XZ,BZ
590 DRAW AZ,BZ
600 DRAW AZ,YZ
610 DRAW XZ,YZ
620 XZ=XZ+64
  :YZ=YZ+64
630 AZ=AZ-64
  :BZ=BZ-64
640 UNTIL XZ>500
650 RESTORE 1710
660 GCOL 0,2
670 FOR IX=1 TO 7
680 READ AZ,BZ
690 MOVE AZ,BZ
700 DRAW AZ,BZ+56
710 NEXT
720 FOR IX=1 TO 7
730 READ AZ,BZ
740 MOVE AZ,BZ
750 DRAW AZ,BZ-56
760 NEXT
770 FOR I=1 TO 6
780 READ AZ,BZ
790 MOVE AZ,BZ
800 DRAW AZ+56,BZ
810 NEXT
820 FOR I=1 TO 5
830 READ AZ,BZ
840 MOVE AZ,BZ
850 DRAW AZ-56,BZ

```

```

860 NEXT
870 GCOL 0,0
880 FOR I=1 TO 7
890 READ AZ,BZ
900 MOVE AZ,BZ
910 DRAW AZ+64,BZ
920 NEXT
930 FOR I=1 TO 8
940 READ AZ,BZ
950 MOVE AZ,BZ
960 DRAW AZ+64,BZ
970 NEXT
980 FOR I=1 TO 9
990 READ AZ,BZ
1000 MOVE AZ,BZ
1010 DRAW AZ,BZ+64
1020 NEXT
1030 FOR I=1 TO 7
1040 READ AZ,BZ
1050 MOVE AZ,BZ
1060 DRAW AZ,BZ+64
1070 NEXT
1080 MOVE 480,552
1090 DRAW 480+48,552
1100 FOR IX=8 TO 11
1110 VDU 19,IX,7,0,0,0
1120 NEXT
1130 VDU 19,VZ+7,15,0,0,0
1140 VDU 19,HZ+7,15,0,0,0
1150 GCOL 0,11
1160 MOVE 1152,200
1170 DRAW 1152,304
1180 DRAW 1120,272
1190 MOVE 1152,304
1200 DRAW 1184,272
1210 GCOL 0,10
1220 MOVE 1152,200
1230 DRAW 1152,96
1240 DRAW 1120,128
1250 MOVE 1152,96
1260 DRAW 1184,128
1270 GCOL 0,9
1280 MOVE 1152,200
1290 DRAW 1048,200
1300 DRAW 1080,168
1310 MOVE 1048,200
1320 DRAW 1080,232
1330 GCOL 0,8
1340 MOVE 1152,200
1350 DRAW 1254,200
1360 DRAW 1222,232
1370 MOVE 1254,200
1380 DRAW 1222,168
1390 COLOUR 5
1400 VDU 4
1410 PRINT TAB(16,2);"Time";

```

IS Y
Or i
In
SPF
*
*
*
SPE
tex
fin
inc
for
ins
thi
cre
SP
tap
is
SP
be
D.

NEVE

Specia
casset
games
BBC 'B
Electro

Cu
CSX10
CSX20
CSX40
+ ma

Sidew
2764
2712
8271

Ad

KS

OFFIC
36 D
Hinch
Leics

SPELLWISE

IS YORE SPELING REELY ATROSHUS?
Or is it just a littel bit off kei?
In either case you need
SPELLWISE.



- * is a spelling checker for use with your BBC micro and WORDWISE word processor
- * is a DISC or tape based machine code program with comprehensive user manuals
- * contains an expandable dictionary of over 6000 words (disc) or 3000 words (tape)

SPELLWISE diligently checks every word in your text against the SPELLWISE dictionary. When it has finished you will be left with a list of words which are incorrectly spelt or not in the base vocabulary.

The program can be interrupted at any stage for inspection of the remaining word list and for the insertion of personal or specialist vocabularies. For this purpose software is included to enable you to create your own data files.

SPELLWISE comprises a set of one disc (or two tapes) plus a complete user manual. The tape version is limited to cassette recorders with motor control. SPELLWISE costs £12 on tape, £18 on disc and can be obtained from:—

DATAWARE FREEPOST SWINDON SN3 4BR

NEVER KNOWINGLY UNDERSOLD — PRICE FOR PRICE, SERVICE FOR SERVICE

Computers

Special Offer — BBC 'B' + cassette recorder + 5 Acornsoft games £346.90
BBC 'B' + D/I £408.00
Electron (ex stock) £173.00

Cumana Disc Drives

CSX100 £120.86
CSX200 £163.00
CSX400 £175.00

+ many more.

Eproms

Sideways ROM Board £36.00
2764's P.O.A.
27128's P.O.A.
8271's P.O.A.

Printers

Epson RX80 £188.95
Epson RX80 F/T £213.00
Epson FX80 £316.00
Epson MX100 £366.00
Epson FX100 £424.00
Daisywheels from £250.00
Printer leads £8.50
Paper (2,000 sheets) £11.00

Monitors

Microvitec 14" £170.00
Sanyo's from £199.00
Saba TV/monitor £200.00

Accessories

Disc Interface £85.00
Wordwise £32.00
Quickshot Joysticks from £5.95

SAE for lists — state machine.

Add 80p carriage - small items. £7.00 carriage - large items.

Add 15% VAT to total

Access and Barclaycard telephone orders to JANE on 0455 612139

Leigh Computer Systems

OFFICE
36 Derby Road,
Hinckley,
Leics. LE10 1QF

SHOP
7 Coventry Road,
Hinckley, Leics.
Tel: 0455 612139

OPENING SOON:
75 Cross Street,
Sale, Manchester
Tel: 061-905 2144

REGARDEZ

LANGUAGE LEARNING AIDS FOR
FRENCH, GERMAN & SPANISH

FOR BBC(32K) · ELECTRON
SPECTRUM (48K)

As used in numerous schools and colleges these programs provide a highly successful aid to modern language learning. Each cassette contains a sophisticated control program and a comprehensive series of vocabulary lessons which can be used in a variety of self-paced learning and test modes. Words, phrases etc are displayed with all necessary accents and special characters, different colours are used for masculine, feminine and neuter words to assist gender learning.

The programs are suitable for beginners, 0-level and beyond as simple commands enable new lessons in vocabulary or grammar to be created by the user, edited as required, then permanently saved for later use. Invaluable for homework and exam revision!

Two cassettes are available for each language, together these contain a vocabulary of thousands of words; Level A provides 16 lessons in general subjects; Level B provides a further 16 lessons including adjectives, adverbs and fully conjugated verb lists.

Available from your computer store or by mail order Price £9.95
Also Available "ANSWER BACK General Knowledge Quiz" Price £10.95



W O R D S O F T W A R E

KOSMOS Software 1 Pilgrims Close, Harlington, DUNSTABLE, Beds. LU5 6LX
Telephone (05255) 3942

Please supply the following programs

The French Mistress Level A @ £9.95 The French Mistress Level B @ £9.95
The German Master Level A @ £9.95 The German Master Level B @ £9.95
The Spanish Tutor Level A @ £9.95 The Spanish Tutor Level B @ £9.95
ANSWER BACK Quiz (Senior) @ £10.95

I have a BBC/Electron/Spectrum computer (delete as necessary)

Mr/Mrs/Miss.....

Address.....

Post code.....
I enclose a cheque/postal order for £..... payable to KOSMOS Software

KOSMOS SOFTWARE
1 Pilgrims Close, Harlington, DUNSTABLE, Beds. LU5 6LX

star **ATTRACTIONS**

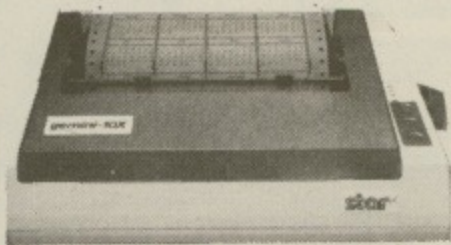

GEMINI 10X



12mHZ Video Bandwidth
RGB and Composite Video

£169.95 + VAT
=£195.44

£189.95

+VAT=£218.44

120CPS · Bi-directional
· Logic seeking · Friction
tractor and roll holder
standard · Downloadable
characters · Ultra high
resolution · 80 cols.
· IBM PC version now
available.



14 INCH COLOUR MONITOR

LOOK!

NEW LOWER PRICES ON EPSON STAR & BROTHER

DAISYWHEEL PRINTERS

BROTHER HR 15	£349.95 + VAT=£402.44
STAR POWERTYPE	£328.95 + VAT=£378.29
EPSON DX 100	£369.95 + VAT=£425.44
JUKI 6100	£325 + VAT=£373.75
DAISYSTEP 2000	£225 + VAT=£258.75

DOT MATRIX PRINTERS

EPSON RX 80	£198.95 + VAT=£228.79
EPSON RX 80F/T	£228.95 + VAT=£263.29
EPSON RX 100	£384.95 + VAT=£442.69
EPSON FX 80	£319.95 + VAT=£367.94
EPSON FX 100	£498.95 + VAT=£573.79
STAR GEMINI-10X	£189.95 + VAT=£218.44
STAR DELTA 10	£319.95 + VAT=£367.94
STAR RADIX 10	£498.95 + VAT=£573.79

THERMAL MATRIX PRINTERS

STAR STX 80	£129.95 + VAT=£149.44
BROTHER HR 5	£129.95 + VAT=£149.44
BROTHER EP 44	£216.95 + VAT=£249.49

Cables - Paper - Ribbons - Sheet Feeders - Tractor
Feeds - Interfaces - Call for Best Prices



**Credit Card
HOT LINE**



01-482 1711

Please Add £10 + VAT for Delivery
Post your cheques/P.O.'s to:

DATASTAR SYSTEMS UK
UNICOM HOUSE, 182 ROYAL COLLEGE STREET,
LONDON NW1 9NN
Telex: 295931 UNICOM G
TAX-FREE EXPORT & DEALER ENQUIRIES WELCOME

M-TEC

AT LAST! **BBCBASIC** to run on YOUR CP/M
Computer

BBCBASIC(Z80)

Now available for the TORCH and DISKPACK
with full GRAPHICS

WHY STRUGGLE ON using OLD FASHIONED BASICs when you can have ALL
THE ADVANTAGES OF **BBCBASIC(Z80)** on your computer?

Of course, we can't turn your computer's video display into a high resolution
colour monitor, but we can give you all the other features of **BBCBASIC**
including:-

- > LONG VARIABLE NAMES
- > MULTI-LINE REPEAT UNTIL STATEMENTS
- > MULTI-LINE NAMED FUNCTIONS
- > MULTI-LINE NAMED PROCEDURES
- > POWERFUL DIRECT MEMORY MANIPULATION USING THE
INDIRECTION OPERATORS
- > AN IN-LINE ASSEMBLER USING STANDARD Z80 MNEMONICS
- > VERY SOPHISTICATED PARAMETER PASSING IN THE CALL
STATEMENT
- > SERIAL RANDOM AND INDEXED DISK FILES PLUS THE ABILITY
TO ACCESS ANY BYTE IN THE FILE
- > CLEAR SCREEN, TAB(X), TAB(X,Y), POS, VPOS and TIME
Plus ALL THE OTHER STANDARD COMMANDS etc.

You can copy any program written in older 'standard' versions of BASIC
with little change OR you can write well-structured and easy to read
programs like a professional.

You need never say GOTO again. But we won't stop you.

Price, including postage, £95 + VAT

TORCH version including SOUND and GRAPHICS £110 + VAT
BBCBASIC(Z80) will run on any computer using CP/M 2.2 or later
and a Z80 processor. It comes complete with an instruction manual, a
tutor on file handling and configuration notes.

Trade enquiries welcome

M-TEC Computer Services (UK), Ollands Road, Reepham, Norfolk

Telephone Norwich 870620

Prestel Mailbox Nos. 603870620

CONTEX

Professional Software for the BBC Computer

Command (?) for help

	Jan	Feb	Mar
1 Car tax	75.00	0.00	0.00
2 Insure	0.00	150.00	0.00
3 Loan	150.00	150.00	150.00
4 Deprec.	100.00	100.00	100.00
5 Repairs	0.00	25.00	0.00
6 Maint.	0.00	0.00	96.00
7 Petrol	36.00	25.00	52.00
8 Oil	0.00	5.00	0.00
9 Other	12.00	3.00	3.00
10			
11 Total	273.00	458.00	361.00
12			
13 Mileage	600.00	400.00	850.00
14 MPG	30.33	29.12	29.75
15 Cost/ml	0.62	1.14	0.42

THE CONTEX SPREADSHEET

The ConTEX Spreadsheet is one of the most versatile
spreadsheet programs available for your BBC
computer. It will process virtually any financial or
statistical column/row analysis calculations you
care to give it. Prepare your home and office
budgets, process accounts, complicated invoices,
job costing, small stock control operations, financial
and statistical modelling, expense evaluations,
foreign exchange etc.

Loaded into your 32K RAM means there is NO ROM
to install (which will save multiple machine
installations a small fortune!). Hundreds now in
use. Compare the spec. this revised, enhanced
version gives you:

Over 1,000 cells in upto 26 columns by 99 rows. Formulae, data or text into any cell. Individually
variable widths (1-30 chrs) and decimal places for each column. Nine digit accuracy. Various
printer format options. Row and column insert or delete with auto formulae adjust. Use all BBC
functions, eg LOG, SIN, SQRT. Many new functions, eg MAX, MIN, SUM, discount factor. Auto
replicate formulae and data with auto adjust. Variables. Colour options. Save and restore to disc or
tape. Four way scrolling. Headings stay on screen. Edit, search, help, model limits. Access to
OS/DFS commands, eg *DISC, *CAT. What-if modify command. Reference any cell by its id or by
its headings. Full instruction booklet.

Cassette £9.99

Disc £12.99

TYPING TUTOR

Specifically designed for your BBC micro to teach and encourage you to fast touch typing.
Professionally enhance your keyboard skills with the 90 smoothly graded lessons and the free
format option. Hundreds in daily use and recommended by adult educational authorities this
program will monitor your progress, intelligently check each line for errors and time you against the
clock in words per minute. Optional audio key feedback, metronomic pacing and revised
performance targets. Auto keyboard/finder display for all lessons including those special ones you
optionally add to the course.

Cassette £9.99

Disc £11.99

Fast delivery. Discs supplied are 5 1/4" please specify if 40 or 80 track required.

CONTEX COMPUTING (B9)

15 Woodlands Close, Cople, Bedford MK44 3UE.

Rollerball listing

From Page 152

```

1420 PRINT TAB(16,6);"Secs";
1430 VDU 5
1440 ENDPROC
1450 DEF PROCINIT1
1460 VDU 5
1470 #FX11,0
1480 ENVELOPE 1,1,70,16,2,2,0,0
      ,126,0,0,-126,80,80
1490 ENVELOPE 2,1,0,0,0,0,0,0,126
      ,-4,0,0,50,25
1500 ENVELOPE 3,1,0,0,0,0,0,0,126
      ,-10,-5,-2,80,80
1510 DIM PZ(5),QZ(5),XZ(5),YZ(5)
      ,NZ(54),DZ(54)
1520 VDU 23,224,112,248,248,248
      ,112,0,0,0
1530 VDU 23,225,112,248,232,192
      ,96,0,0,0
1540 VDU 23,226,96,192,232,248,112
      ,0,0,0
1550 VDU 23,227,112,248,184,24,48
      ,0,0,0
1560 VDU 23,228,48,24,184,248,112
      ,0,0,0
1570 QZ=0
1580 RESTORE 3110
1590 FOR IX=1 TO 54
1600 READ NZ(IX),DZ(IX)
1610 NEXT
1620 ENDPROC
1630 DEF PROCINIT2
1640 HZ=1
      :MZ=16
      :VZ=4
      :NZ=8
      :DZ=2
      :EZ=0
      :CZ=0
1650 XZ(1)=16
      :YZ(1)=24
1660 XZ(2)=16
      :YZ(2)=992
1670 XZ(3)=960
      :YZ(3)=24
1680 XZ(4)=960
      :YZ(4)=992
1690 ENDPROC
1700 REM MAZE DATA
1710 DATA 208,4,800,4,608,68,256
      ,132
1720 DATA 674,132,512,196,576,324
1730 DATA 512,996,192,932,848,932
1740 DATA 528,868,704,804,640,740
1750 DATA 384,676,8,504,72,320,72
      ,720
1760 DATA 136,400,200,640,264,504

1770 DATA 1000,304,1000,800,936
      ,400
1780 DATA 872,600,746,400
1790 DATA 320,64,640,64,400,128
      ,800,128
1800 DATA 320,192,560,256,432,320
1810 DATA 320,936,640,936,224,872
1820 DATA 720,872,416,808,592,808
1830 DATA 400,744,560,680,64,96
      ,64,360
1840 DATA 64,608,128,504,128,752
      ,192,256
1850 DATA 192,496,256,320,384,480
1860 DATA 944,128,944,640,880,512
1870 DATA 816,256,752,624,688,480
1880 DATA 624,400
1890 DEF PROCMAINLOOP
1900 REPEAT
1910 PROCMUSIC
1920 IF CX<>3
      THEN 1940
1930 IF INKEY (-102)
      THEN VDU 19,2,2,0,0,0,0
      ELSE VDU 19,2,0,0,0,0,0
1940 I$=INKEY$(0)
      :IF I$=""
      THEN 2070
1950 GX=HZ
      :UX=VZ
1960 IF INKEY (-67) HZ=1
      :MZ=16
      :GOTO 2000
1970 IF INKEY (-98) HZ=2
      :MZ=-16
      :GOTO 2020
1980 IF INKEY (-105) VZ=3
      :NZ=-8
      :GOTO 2000
1990 IF INKEY (-73) VZ=4
      :NZ=8
      :GOTO 2010
2000 IF HZ=1 AND VZ=3
      THEN DZ=1
      :GOTO 2040
2010 IF HZ=1 AND VZ=4
      THEN DZ=2
      :GOTO 2040
2020 IF HZ=2 AND VZ=3
      THEN DZ=3
      :GOTO 2040
2030 IF HZ=2 AND VZ=4
      THEN DZ=4
2040 IF GX<>HZ VDU 19,GX+7,7,0,0
      ,0
2050 IF UX<>VZ VDU 19,UX+7,7,0,0
      ,0
2060 VDU 19,VZ+7,15,0,0,0
      :VDU 19,HZ+7,15,0,0,0

2070 FOR BZ=1 TO LZ
      :XZ=XZ(BZ)
      :YZ=YZ(BZ)
      :SZ=MZ
      :TZ=NZ
      :PROCHECK
      :GCOL 0,0
      :MOVE XZ(BZ),YZ(BZ)
      :VDU 224+DZ
      :XZ(BZ)=XZ(BZ)+SZ
      :YZ(BZ)=YZ(BZ)+TZ
      :MOVE XZ(BZ),YZ(BZ)
      :GCOL 0,1
      :VDU 224
      :NEXT
      :PROCTIME
      :PROCWIN
      :UNTIL EZ=1
2080 ENDPROC
2090 DEF PROCHECK
2100 ON DZ GOTO 2110 ,2200 ,2290
      ,2380
2110 IF POINT(XZ+48,YZ-12)<>0 SZ=0
      :GOTO 2150
2120 IF POINT(XZ+48,YZ-8)<>0 SZ=0
      :GOTO 2150
2130 IF POINT(XZ+48,YZ-16)<>0 SZ=0
      :GOTO 2150
2140 IF POINT(XZ+48,YZ-20)<>0 SZ=0
2150 IF POINT(XZ+24,YZ-24)<>0 TZ=0
      :ENDPROC
2160 IF POINT(XZ+16,YZ-24)<>0 TZ=0
      :ENDPROC
2170 IF POINT(XZ+32,YZ-24)<>0 TZ=0
      :ENDPROC
2180 IF POINT(XZ+40,YZ-24)<>0 TZ=0
2190 ENDPROC
2200 IF POINT(XZ+48,YZ+4)<>0 SZ=0
      :GOTO 2240
2210 IF POINT(XZ+48,YZ-8)<>0 SZ=0
      :GOTO 2240
2220 IF POINT(XZ+48,YZ)<>0 SZ=0
      :GOTO 2240
2230 IF POINT(XZ+48,YZ-4)<>0 SZ=0
2240 IF POINT(XZ+24,YZ+8)<>0 TZ=0
      :ENDPROC
2250 IF POINT(XZ+32,YZ+8)<>0 TZ=0
      :ENDPROC
2260 IF POINT(XZ+40,YZ+8)<>0 TZ=0
      :ENDPROC
2270 IF POINT(XZ+16,YZ+8)<>0 TZ=0
2280 ENDPROC
2290 IF POINT(XZ-16,YZ-12)<>0 SZ=0
      :GOTO 2330
2300 IF POINT(XZ-16,YZ-8)<>0 SZ=0
      :GOTO 2330

```

MUSICSOFT

MUSIC SPECIALISTS FOR THE 32K BBC MICRO

★ THE SYNTH ★ (O.S. 1.0+)

"A very flexible and inventive program that's highly recommendable." (Dr David Ellis, E&MM, Oct 83). This 'synthesizer' program has features which to our knowledge are unique. ALTER RHYTHM. The rhythm of a recorded melody may be altered by tapping on a single key. REPEAT. No need to play a phrase twice, great saving in space. REAL TIME PLAYING. With alteration of volume, envelope and octave pitch as you play a note. EDITING. Back and forwards whilst hearing the tune. INPUT. May be hesitant or in control. TIDY. 'Clears up' inaccuracies of input on demand! NUMBER OF NOTES. From 3000 for 1 channel to 1000 for 3, etc. Plus all the other synthesizer programs do PLUS. IE sophisticated envelope editing (very easy), larger keyboard used (TAB to ↵ cursor). No secrets, user transparent. This is the program for the experimenter who wants to make HUMAN music rather than perform mathematical finger dexterity exercises. THE SYNTH. Cassette & instructions only £8.75 inc. P&P.

★ KEYBOARDS ★ (O.S. 1.0+)

5 programs to turn your BBC into 5 real-time keyboards. 1. 3 simultaneous voices (in Basic for easy understanding) 2. Single voice M/C with Pitch Bend. 3. 3 simultaneous voice M/C with Envelope control built in. 4. Single finger Chord organ ranging over the whole keyboard, 2 variations for each chord. 5. Chord organ 2 with different chord configuration. These are all separate programs designed for you to use as they are or in your own programs.

KEYBOARDS cassette & instructions £5.75 inc P&P

★ MUSICTOOLS ★ (all O.S.)

"Musicsoft also produce an excellent 'Musictools 1' cassette... all in all, rather good value" (E&MM, Oct 83)

Five music utility programs on one tape.

Tune Generator with dynamic graphic Keyboard & Stave display, Envelope Command Explorer (Very easy to use), Musical Symbols Graphic routine, Simple single line organ with sophisticated controls. Over 60 procedures for you to use in your programs already in working programs.

MUSICTOOLS 1 cassette & instructions £5.75 inc. P&P.

★ PIEMAN ★ (all O.S.)

"The best version of Simon I've seen, it goes so much further than most" (Quote by a rival software firm!) Recommended for Primary & Middle Schools. Not as simple as Simon! It develops into a fun set of ear cleaning and musical concentration games.

PIEMAN cassette & instructions £5.75 inc. P&P.

ACORN APPROVED
ALL PROGRAMS TRANSFER EASILY TO DISC.

Cheques and official orders to:
MUSICSOFT, 12 Fallowfield, Amptill, Beds.
Telephone: 0525 402701

All 4 programs on 40 track disc - £26.00

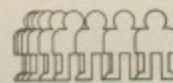

MICROMAN Computers

ACORN SPECIALIST COMPUTER CENTRE

ACORN/BBC COMPUTERS:

Acorn Electron	199.00
BBC Model B	399.00
BBC Model B + DFS	469.00
Acorn Teletext Receiver	225.00
Acorn 6502 2nd Processor	199.00
Acorn Z80 2nd Processor	299.00
Acorn IEEE Interface	325.00
Bitstick	375.00
Electron Plus I Interface	59.90

BBC UPGRADES:

A-B Upgrade (Fitted)	95.00
DFS Interface (Fitted)	109.00
Speech Synthesizer (Fitted)	55.00

PRINTERS:

Epson RX80FT	295.00
Epson FX100	574.95
Star Gemini 10X	268.00
Star Delta 10	385.00
Cannon PW-1080A	330.00
Shinwa CP80	220.00
Sanple Daisywheel Printer	332.35

TORCH COMPUTERS:

Z80 Disc Pack	799.00
Z80 2nd Processor Card	339.00

BBC FIRMWARE:

Word ROM	59.80
Viewsheet ROM	44.85
Viewsheet ROM	59.80
B-Base Database Disc	25.00
Ultracalc Spreadsheet ROM	74.75
Computer Concepts from	33.35
Toolstar ROM	34.00
Commstar EPROM	34.00
BCPL ROM	99.65
Sidewise ROM	44.70
Solidisk 32K Sideways RAM	57.95
Solidisk 96K Extension	92.00
Solidisk 128K Sideways RAM	149.95

MODEMS:

Grapevine/Commstar Modem	P.O.A.
--------------------------	--------

MONITORS:

Decca RGB Standard	228.85
Microvitec Cub Standard	228.85
Zenith Green	109.25
Decca TV/Monitor	265.00

DISC DRIVES:

Full range available	POA
----------------------	-----

NOW AVAILABLE - 208K SOLIDISK
WE OFFER A FULL RANGE OF SOLIDISK SIDEWAYS
RAM PRODUCTS INC. A SOLIDISK FITTING SERVICE

WE HAVE A RANGE OF BUSINESS & WORD
PROCESSING PACKAGES BASED AROUND THE BBC
& TORCH COMPUTERS

ACORN APPROVED SERVICE CENTRE
Our workshop offers a comprehensive service including
Repairs and Upgrades by our own engineers

EDUCATIONAL & INDUSTRIAL ENQUIRIES WELCOME



All prices include VAT, Post & Packing £9 (Large items) £1 (Small items ROM's etc)



RAINFORD INDUSTRIAL ESTATE, MILL LANE,
RAINFORD, ST. HELENS, MERSEYSIDE

PHONE 074488 5242

NEW

QFS

BBC Disc Upgrade complete disc interface and DFS

NEW

Available
ex-stock
NOW!

- Supports single and DOUBLE DENSITY
- Automatic density recognition
- Acorn compatible (beware non-compatible DFS)
- Supports single and double-sided discs
- Supports 40 or 80 tracks
- Up to 256 files per disc
- Firmware Format and Verify
- Complete with manual
- Simple to fit yourself - everything you need is supplied (including instructions!) No soldering - just plug in

Available
ex-stock
NOW!

£95

+VAT

INTRODUCTORY OFFER - Special limited number of Superslim Disc Drives - Double Sided 40 track (400K) complete with QFS - Just plug in and go for £269 inc VAT and carriage.

Microdis

46 Middle St, Blackhall, Hartlepool, Cleveland.
Tel: Peterlee (0783) 872430.

Rollerball listing

From Page 155

```

2310 IF POINT(XZ-16,YZ-16)<>0 SZ=0
      :GOTO 2330
2320 IF POINT(XZ-16,YZ-20)<>0 SZ=0
2330 IF POINT(XZ+8,YZ-24)<>0 TZ=0
      :ENDPROC
2340 IF POINT(XZ+16,YZ-24)<>0 TZ=0
      :ENDPROC
2350 IF POINT(XZ,YZ-24)<>0 TZ=0
      :ENDPROC
2360 IF POINT(XZ-8,YZ-24)<>0 TZ=0
2370 ENDPROC
2380 IF POINT(XZ-16,YZ-44)<>0 SZ=0
      :GOTO 2420
2390 IF POINT(XZ-16,YZ-8)<>0 SZ=0
      :GOTO 2420
2400 IF POINT(XZ-16,YZ)<>0 SZ=0
      :GOTO 2420
2410 IF POINT(XZ-16,YZ+4)<>0 SZ=0
2420 IF POINT(XZ+8,YZ+8)<>0 TZ=0
      :ENDPROC
2430 IF POINT(XZ+16,YZ+8)<>0 TZ=0
      :ENDPROC
2440 IF POINT(XZ,YZ+8)<>0 TZ=0
      :ENDPROC
2450 IF POINT(XZ-8,YZ+8)<>0 TZ=0
2460 ENDPROC
2470 DEF PROCTIME
      :VDU 4
      :VDU 23,1,0;0;0;0;
      :COLOUR 5
      :TZ=INT (TIME /100)
      :PRINT TAB(16,4);TZ;
      :VDU 5
      :ENDPROC
2480 DEF PROCWIN
      :IZ=1
2490 IF XZ(IZ)>448 AND XZ(IZ)<520
      AND YZ(IZ)<560 AND YZ(IZ)>464
      THEN IZ=IZ+1
      ELSE ENDPROC
2500 IF IZ<>LZ+1 GOTO 2490
2510 EZ=1
      :ENDPROC
2520 DEF PROCEND
2530 SOUND 3,1,100,10
2540 FOR AZ=0 TO 600
      :PROC MUSIC
      :NEXT
2550 ENDPROC
2560 DEF PROCINSTRUCTIONS
2570 PRINT TAB(9,0);CHR$(141);
      CHR$(129);"ROLLER BALL"
2580 PRINT TAB(9,1);CHR$(141);
      CHR$(129);"ROLLER BALL"
2590 PRINT TAB(8,3);CHR$(130);"By
      Geoff Turner"
2600 PRINT ""
2610 PRINT "This game simulates a
      plastic maze"
2620 PRINT "with a number of ball
      bearings."
2630 PRINT
2640 PRINT "The object of the game
      is to tilt"
2650 PRINT "the maze and steer all
      the balls to"
2660 PRINT "the centre of the maze."
2670 PRINT
2680 PRINT "The game ends when all
      the balls"
2690 PRINT "have reached the central
      square."
2700 PRINT ""
2710 PRINT SPC(8);CHR$(133);"PRESS
      SPACE BAR."
2720 REPEAT
      : PROC MUSIC
      : UNTIL INKEY (-99)
2730 REPEAT
      : PROC MUSIC
      : UNTIL NOT INKEY (-99)
2740 CLS
2750 PRINT ""
2760 PRINT "Tilt the maze using the
      following keys."
2770 PRINT
2780 PRINT SPC(9);CHR$(134);"Z
      tilts left"
2790 PRINT SPC(9);CHR$(134);"X
      tilts right"
2800 PRINT SPC(9);CHR$(134);"*
      tilts up"
2810 PRINT SPC(9);CHR$(134);"?
      tilts down"
2820 PRINT
2830 PRINT "The direction of tilt
      is shown by"
2840 PRINT "the arrows at the bottom
      right of"
2850 PRINT "the screen."
2860 PRINT
2870 PRINT "The time taken is shown
      by the clock"
2880 PRINT "at the top of the screen."
2890 PRINT ""
2900 PRINT SPC(8);CHR$(133);"PRESS
      SPACE BAR"
2910 REPEAT
      : PROC MUSIC
      : UNTIL INKEY (-99)
2920 REPEAT
      : PROC MUSIC
      : UNTIL NOT INKEY (-99)
2930 CLS
2940 PRINT ""
2950 PRINT "Choose your skill level"
2960 PRINT
2970 PRINT CHR$(130);"1. Easy
      - two balls"
2980 PRINT CHR$(130);"2. Hard
      - four balls"
2990 PRINT CHR$(130);"3. Impossible
      - invisible maze"
3000 PRINT ""
3010 PRINT "When using the invisible
      maze press"
3020 PRINT "key 'M' to make the maze
      visible"
3030 PRINT ""
3040 PRINT CHR$(130);"CHOOSE 1,2
      or 3. ";
3050 *FX21,0
3060 REPEAT
      : C$=INKEY$(0)
      : PROC MUSIC
      : UNTIL C$="1" OR C$="2"
      OR C$="3"
3070 CX=VAL(C$)
3080 IF CX=1
      THEN LZ=2
      ELSE LZ=4
3090 ENDPROC
3100 REM MUSIC DATA
3110 DATA 69,2,77,1,69,1,65,1,57
      ,1,49,2,37,2,57,2,29,2,17,2
      ,49,2,57,1,49,1,57,1,65,1,69
      ,2,69,2,77,1,69,1,65,1,57,1
3120 DATA 49,2,37,2,57,2,29,2,17
      ,2,49,2,57,6,69,2,69,2,69,2
      ,45,2,45,2,45,2,77,2,77,2,77
      ,2
3130 DATA 65,2,65,1,69,1,65,2,85
      ,2,85,1,77,1,85,2,45,2,45,1
      ,37,1,45,2,65,2,57,2,49,2,49
      ,2,57,4
3140 DEF PROC MUSIC
      : CALL &D00
      : IF ?&70=0 ENDPROC
3150 QZ=QZ+1
      : IF QZ=55 QZ=1
3160 SOUND 1,2,NZ(QZ)+100,DX(QZ)*3
      : SOUND 2,3,NZ(QZ)+80,DX(QZ)*3
      : ENDPROC

```

This listing is included in this month's cassette tape offer. See order form on Page 193.

CLEARLY HE HAD ONLY ONE KEYBOARD IN MIND WHEN HE DESIGNED THE HUMAN HAND

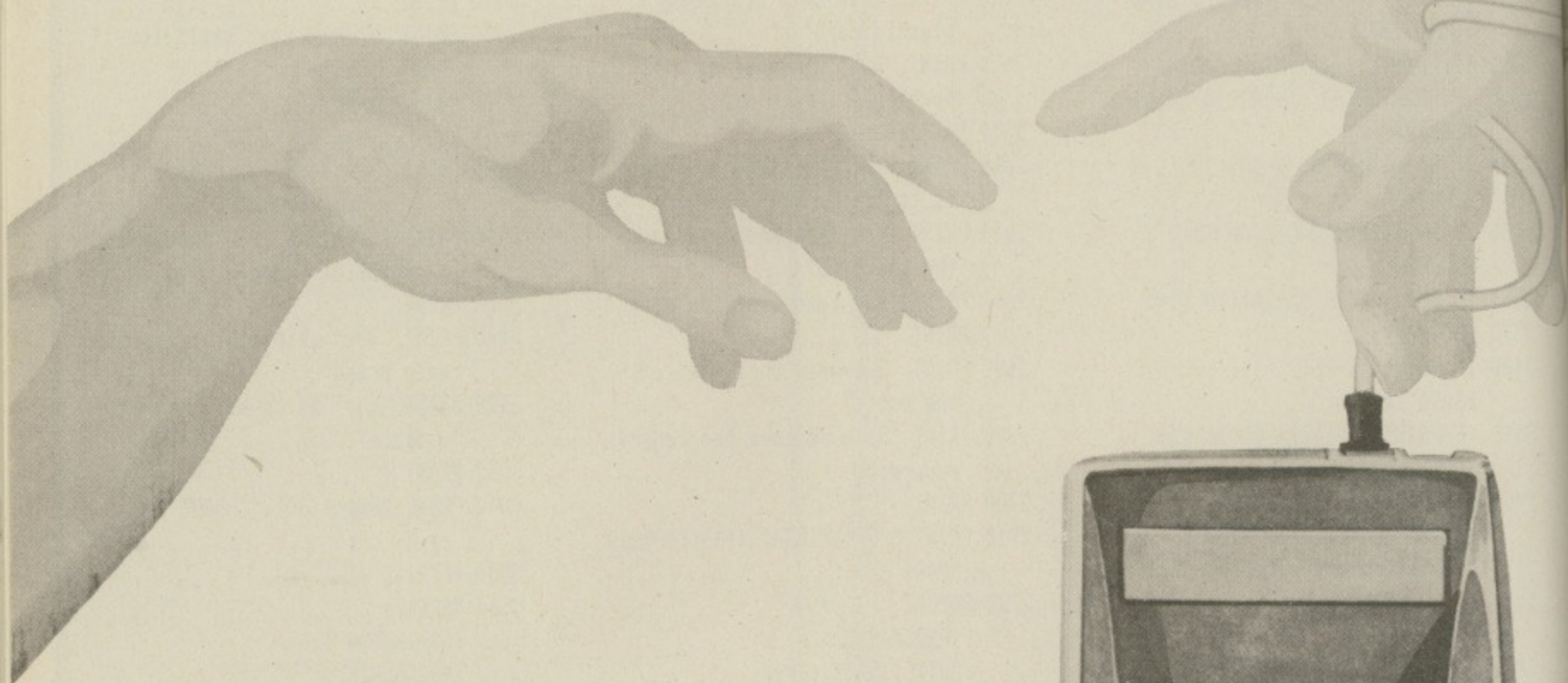

IMAGINE A KEYBOARD

... so simple to use that in under an hour you're touch typing the entire alphabet, numbers and punctuation.

... so effortless it needs only one hand, your eyes never leaving the screen or the document you're copying.

A keyboard you can hold in your palm, and yet, so powerful, it can replace every input, command and function key of your BBC computer ...

Just think how effortless it would be if you could *touch type* your programs, data and text.

How you could lean back and relax; be faster and more accurate; your mind free to think, and your eyes to read.

IT'S CALLED **QUINKEY**

And for **£49.95** you'll get everything you need — hardware and software — to use Quinkey with your BBC computer.

HOW CAN 6 KEYS DO THE WORK OF 72?

You simply press the keys in different combinations. Each combination represents a character.

Quinkey has 5 keys plus a Control key, each finger belonging to its own key — so there's no need to hunt and peck ... BUT ...

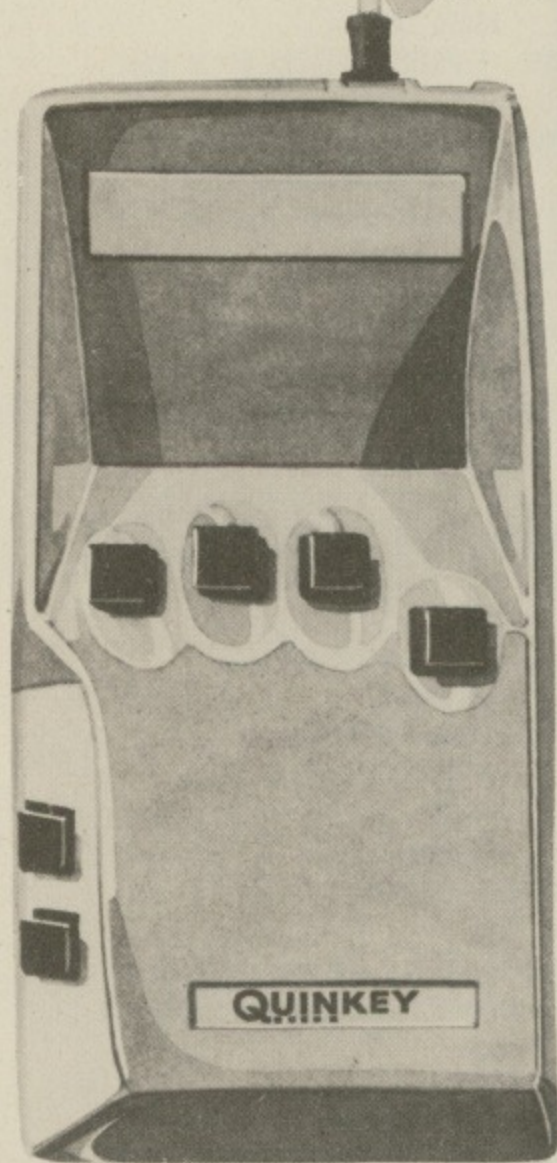

... HERE'S THE MAGIC!

Look at these diagrams:

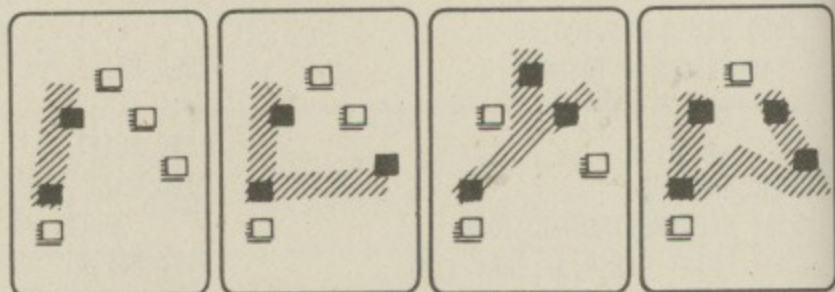

See how the lines joining the key combinations form the characters? For each letter there's an instantly recognised and easily memorised visual clue.

That's the trick — and it works!

YOU C

Rest

Imagine

To w

down at

For a

fingers.

To w

fingers.

That

Here

— PETE

World')

easier th

starting

— PETE

Supple

hour's u

— FRAN

Times

so gene

NO R

If yo

within

ONLY

HERE'

★ On

★ Bre

key

★ Tw

(de

★ Co

"P

utility

"P

the sig

with y

Quink

"W

proces

a perfe

KEY

Al

Quink

TECHN

Loading

No zero

Interru

TESTE

BBC M

OS 1.2

BASIC

INKEY

DFS 0.0

View A

Wordv

Edwor

YOU CAN TRY IT NOW!

Rest the fingers of your right hand on a table top. Imagine the keys.

To write an "I" you press your Thumb and Index finger down at the same time.

For an "L" you press your Thumb, Index and Little fingers.

To write "Y" you use your Thumb, Middle and Ring fingers . . . and so on.

That's all there is to it.

Here's what users are saying about the keyboard:

-PETER RODWELL (as Editor of 'Personal Computer World') "took me half an hour to learn the alphabet . . . far easier than learning to type. It's an addictive device, and I'm starting to wonder how I ever managed without one."

-PETER WHEELER (in the 'Times Educational Supplement') "a new user can start to touch type after one hour's usage."

-FRANK DALE (BBC Producer - writing in 'Electronic Times') "no other machine is so easy to use, so easy to learn, so generally useful . . ."

NO RISK, MONEY BACK GUARANTEE.

If you're unhappy with your Quinkey just return it within two weeks for a full and courteous refund.

ONLY £49.95 (including VAT and postage & packing).
HERE'S WHAT YOU GET.

- ★ One Quinkey keyboard.
- ★ Breakthrough multi-channel interface for up to four keyboards (plug into analogue port).
- ★ Two new powerful software packages, PROG & WP (described below).
- ★ Comprehensive Quinkey manual.

"PROG" and "WP" (free with the Quinkey package) are utility programs written specially for the BBC.

"PROG" enables your BBC to recognise and interpret the signals from the Quinkey keyboard. It combines easily with your application programs enabling you to use Quinkey as a comprehensive alternative keyboard.

"WP" optimises Quinkey to work with word-processing packages "Wordwise," "View" and "Edword" - a perfect text-writing combination.

KEYBOARD RANGE.

All BBC "B" keyboard inputs generate from the Quinkey, except the hard-wire key, "Break."

TECHNICAL DATA:

Loading length: &605. Running length: &300.
No zero-page locations, all ADC channels.
Interrupt service vector IRQ2V, correctly chained.

TESTED COMPATIBILITY

BBC Model "B"	Acorn
OS 1.2	
BASIC I or BASIC II (unless using INKEY with negative argument)	Acorn
DFS 0.90	Acorn
View A1.4	Acornsoft
Wordwise 1.17	Computer Concepts
Edword	Clwyd Technics

QUINKEY IN THE CLASSROOM.

Quinkey keyboards allow up to four children to use one BBC computer at the same time. "QUAD" software supplied with the Educational Pack enables children to write simultaneously on a split screen and print out their work separately.

(Send the coupon if you would like more information about the remarkable results that children of all ages and abilities are having with Quinkey.)

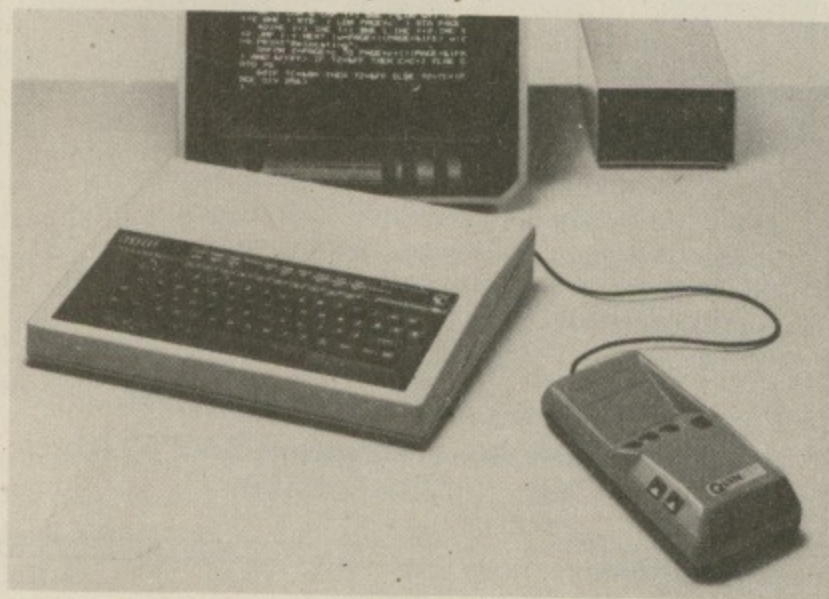

Order from your nearest BBC Acorn dealer or by sending in the coupon below, now.

microwriter

An associate company of the Hambro Life Group of Companies

31 Southampton Row, London WC1B 5HJ

To: Vector Marketing Ltd., Denington Estate, Wellingborough, Northants. NN8 2RL.

PLEASE SEND:

001 _____ Quinkey pack(s) @ £49.95 £ _____

002 _____ Extra keyboard(s) @ £29.95 £ _____

003 _____ Educational Pack(s) @ £148.80 £ _____

(Quinkey pack plus 3 extra keyboards and additional "QUAD" software)

+ postage and packing £ 2.50

I realise that I can return the pack(s) undamaged within two weeks of receipt of order, if I am not fully satisfied, for a complete refund.

Send more information about Quinkey in the classroom.

I enclose a cheque made payable to:

Vector Marketing "Microwriter Ltd" for £ _____

Or debit my Visa/Access credit card No. _____

SIGNED: _____

NAME: _____

ADDRESS: _____

MU/8/84

Please allow up to 28 days for delivery.

Reg. no. 1374069

microwriter
QUINKEY

THE BEST IDEA SINCE THE HUMAN HAND

THE Voxbox Recognises Voice, Too

With the Voxbox voice digitiser.

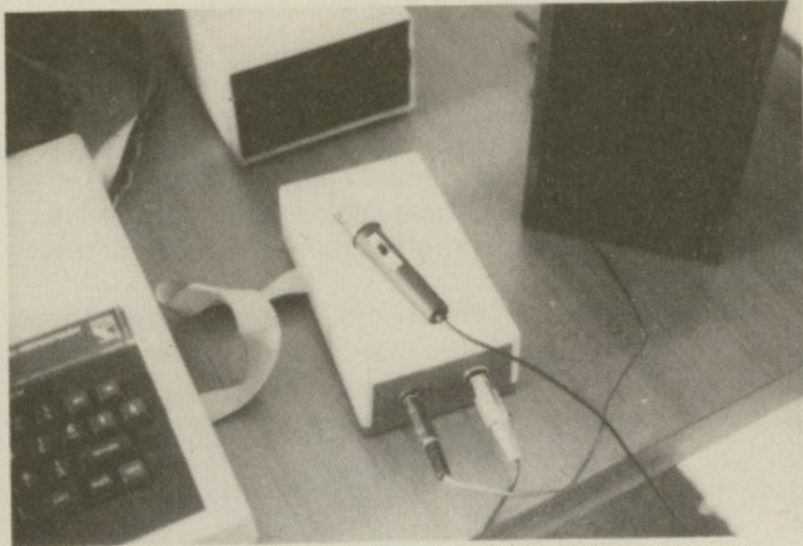

The Voxbox has a new capability. As before, normal human voice can be stored on disc and accessed from your own programmes. Now also, the same Voxbox can be used for Voice Recognition. Make your BBC Speak AND Understand. Complete system **£97.00 all inc.**
For information and sales, please contact:

Multiplex Computer Services
250, Eastern Road, Brighton BN2 5TA.
Tel: (0273) 606860

C15 COMPUTER CASSETTES

35p

- ★ Quality computer cassettes
- ★ Leaderless tape
- ★ Screw construction
- ★ Plastic library case
- ★ Approved by leading software house

Box of 10... **£3.50** + £1 p&p
Cheques, P.O.'s to:

HAYSTACK PERIPHERALS
5 Church Road,
Greenfield,
Oldham OL3 7LQ.

Educational and Dealer Enquiries Welcome

GUARDIAN SOFTWARE

presents for DISC OWNERS

SOURCE LIBRARY MANAGER (SLM)

A new concept in ROM based software for the BBC MICRO

Features include:

- Stores and retrieves any amount of BASIC and/or ASSEMBLER source code, up to the full capacity of a disk (100k/200k).
- Creates a LIBRARY of up to 399 "members" per 80 track disk or up to 199 "members" per 40 track disk.
- Allows up to 99 versions of a single program or routine.
- Will simply and easily "construct" programs developed in a modular fashion.
- Stores fully documented code which can be "stripped" when required for execution.
- Uses 8 char names and 20 char description for each "member".
- Is fully menu-driven (i.e. no messy command syntax).
- Includes comprehensive manual and fitting instructions.
- Many other features too numerous to list here.

*** FULLY COMPATIBLE WITH 6502 SECOND PROCESSOR ***

IDEAL FOR BEGINNERS AND EXPERIENCED PROGRAMMERS ALIKE

PRICE **£36** (incl. p&p) or large SAE for Fact Sheet to:

GUARDIAN SOFTWARE
21 Harvey Road, Walton-on-Thames,
Surrey KT12 2PZ.

COPY HOLDER

The DATAMASTER Hard Copy Holder solves that oldest of problems, where to balance your copy whilst entering data or programs.

Solid, all metal construction, designed to stand steady and resist knocks and scratches. With non-slip, non-scratch rubber feet.

Can support a whole book or magazine or even a single sheet with the help of the magnetic cursor which also helps you to keep your place. Saves you time and frustration.

Full money-back guarantee. Available only while stocks last.

Send cheque or postal order NOW for **£6.95** to HALEWOOD PRODUCTS, P.O. Box 9, Northwich, Cheshire CW9 7TP

ONLY £5.95
(+£1.00p&p)

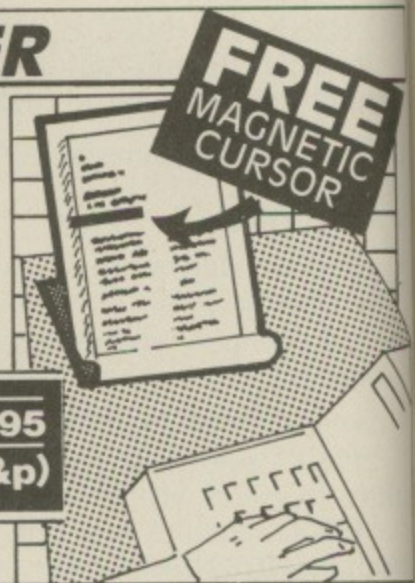

SAY GOODBYE TO GOTO!

Step by Step BASIC

BBC Micro/ Electron edition by Richard Freeman

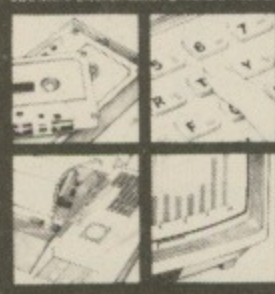

And to the bugs and the spaghetti! With Step by Step BASIC you learn to write well-structured programs from day 1. Programs that work and that you can see will work. Colour, sound, graphics, files, sorting all included.

BBC/Electron edition (203 pp) **£5.95**
BBC/Electron program tape **£5.50**
ZX Spectrum edition (177 pp) **£5.95**
ZX Spectrum program tape **£5.50**

LIFELONG LEARNING LTD.
Dept EU, 55 MILTON ROAD,
CAMBRIDGE CB4 1XA

Villains listing

From Page 99

```

5 REM (c) The Micro User
10 #FX9,8
20 #FX10,8
30 PROCinit
40 ONERRORMODE7:PROCerr
50 MODE7:PROCinstruct:MODE2:VDU23;
8202;0;0;0;VDU5
60 PROCvar:PROCscreensetup:REPEAT:
RX=RND(4):PROCscore
70 IFRX=1PROCvillain(16,4)
80 IFRX=2PROCvillain(24,2)
90 IFRX=3PROCassasin
100 IFRX=4PROCchugo
110 IFmenX<OGOSUB1000
120 IFkilledX=0PROCwave
130 UNTILFALSE
140 DEFPROCvar:FORcolX=1TO4:goldX(c
olX)=1:NEXT:goldposX(1,1)=616:goldpos
X(1,2)=638:goldposX(2,1)=806:goldposX
(2,2)=448:goldposX(3,1)=616:goldposX(
3,2)=258:goldposX(4,1)=426:goldposX(4
,2)=448
150 xposX(1)=1060:xposX(2)=156:ypos
X(1)=220:yposX(2)=739:XZ=640:YZ=448:R
Z=RND(4):menX=7:printX=1:scoreX=0:hug
oX=36:speedX=32:CZ=speedX:killedX=13:
waveX=0:distX=360:ENDPROC
160 DEFPROCscreensetup:GCOL0,4:MOVE
100,795:DRAW1180,795:DRAW1180,100:DRA
W100,100:DRAW100,795:GCOL0,1:MOVE100,
1000:DRAW1180,1000:DRAW1180,800:DRAW1
00,800:DRAW100,1000:VDU24,108;108;117
2;787;:PROCbars:VDU4:COLOUR4
170 PRINTTAB(2,2);"SCORE:";TAB(2,5)
;"ENERGY:";COLOUR1:FORcolX=9TO16:PRIN
TTAB(colX,5);CHR$250:NEXT:VDU5:ENDPRO
C
180 DEFPROCkey:PROCbar
190 IF(?&EC OR?&ED)=0PROCman:ENDPRO
C
200 IFINKEY(-98)CX=-speedX:PROCmove
x
210 IFINKEY(-67)CX=speedX:PROCmovex
220 IFINKEY(-88)DX=speedX:PROCmovey
230 IFINKEY(-104)DX=-speedX:PROCmov
ey
240 IFINKEY(-99)PROCgun
250 ENDPROC
260 DEFPROCmovex:IF(XZ+CX)>1108DR(X
Z+CX)<108ENDPROC
270 PROCwipe(XZ,YZ):XZ=XZ+CX:PROCma
n:ENDPROC
280 DEFPROCmovey:IF(YZ+DX)>787OR(YZ
+DX)<172ENDPROC
290 PROCwipe(XZ,YZ):YZ=YZ+DX:PROCma
n:ENDPROC
300 DEFPROCgun:SOUND17,4,230,29:SOU
ND16,-15,7,29:FORcolX=4TO0STEP-4:MOVE

```



```

(XZ+32)+(SGN(CZ)*32),(YZ-24):GCOL3,1:
PLOT1,SGN(CZ)*1030,0:PROCdelay(colX):
NEXT:IFABS((YZ-26)-(YZ-32))<32AND(SGN
(xZ-XZ)=SGN(CZ))RX=0
310 ENDPROC
320 DEFPROCvillain(stepX,colourX):B
X=1:REPEAT:colX=RND(4):UZ=goldposX(co
lX,1):VX=goldposX(colX,2):UNTILgoldX(
colX)>0:varX=colX:colX=RND(2):xZ=xpos
X(colX):colX=RND(2):yZ=yposX(colX):AZ
=2:REPEAT
330 IFAZ=3colX=RND(2):UZ=xposX(colX
):colX=RND(2):VZ=yposX(colX):VDU25,4,
goldposX(varX,1);goldposX(varX,2);18,
0,0,250:goldX(varX)=0:AZ=4
340 PROCchome:IFmenX=0PROCkey
350 IFAZ=4ANDABS(UZ-xZ)<=48ANDABS(V
Z-yZ)<=48BZ=0
360 UNTILRX=0OR BX=0 OR menX<0:PROC
wipe(xZ,yZ):IFRX=0scoreX=scoreX+80:ki
lledX=killedX-1:IFRX=0ANDAZ=4VDU25,4,
xZ;yZ-32;18,0,8,251,8,18,0,15,252:gol
dposX(varX,1)=xZ:goldposX(varX,2)=yZ-
32:goldX(varX)=1
370 IFBZ=0UZ=0:FORcolX=1TO4:UZ=UZ+g
oldX(colX):NEXT:IFUZ=0menX=-2
380 ENDPROC
390 DEFPROCchome:PROCwipe(xZ,yZ):xZ=
xZ+(SGN(UZ-xZ)*(stepX*AZDIV2)):yZ=yZ+
(SGN(VZ-yZ)*(stepX*AZDIV2)):VDU25,4,x
Z;yZ;IFAZ=2PROCvdu ELSEPROCvdu1
400 colX=RND(17):IFcolX=8PROCshoot
410 IFAZ=2ANDABS((UZ+12)-(xZ+32))<4
4ANDABS((VZ-8)-(yZ-32))<40AZ=3
420 ENDPROC
430 DEFPROCvdu:VDU18,0,colourX,244,
8,18,0,3,245,8,18,0,1,246,10,8,18,0,c
olourX,247,8,18,0,1,248:ENDPROC
440 DEFPROCvdu1:VDU18,0,colourX,244
,8,18,0,3,245,8,18,0,1,246,10,8,18,0,
8,251,8,18,0,15,252,8,18,0,1,253,8,18
,0,colourX,254:ENDPROC
450 DEFPROCshoot:spare1X=(31-RND(62
))*8:FORcolX=5TO0STEP-5:MOVE(xZ+32),(
yZ-16):GCOL3,5:SOUND&10,0,0,5:SOUND&1
1,1,255,5:DRAW(XZ+32)+spare1X,(YZ-32)
+spare1X:PROCdelay(colX):NEXT:IFABSsp

```

```

are1X<32PROChit
460 ENDPROC
470 DEFPROCchit:menX=menX-1:VDU19,0,
7;0;:VDU4:COLOUR0:PRINTTAB(10+menX,5)
;CHR$250:VDU5
480 VDU19,0,0;0;:ENDPROC
490 DEFPROCdelay(aZ):TIME=0:REPEATU
NTILTIME>aZ:ENDPROC
500 DEFPROCassasin:yZ=YZ:AZ=0:IFXX>
=640XZ=120:BZ=40ELSEXZ=1118:BZ=-40
510 UZ=xZ:spare1X=xZ:REPEAT:IFABS(s
pare1X-xZ)<distXANDAZ=0PROCrun ELSE P
ROCfire
520 IFmenX=0PROCkey
530 UNTILABS(UZ-xZ)<40ORRX=0ORmenX<
0:PROCwipe(xZ,yZ):IFRX=0scoreX=scoreX
+100:killedX=killedX-1
540 ENDPROC
550 DEFPROCassass:VDU25,4,xZ;yZ;18,
0,4,229+(5*SGN(BZ)),8,18,0,7,230+(5*SG
N(BZ)),8,18,0,1,231+(5*SGN(BZ)),10,8
,18,0,4,232+(5*SGN(BZ)),8,18,0,1,233+
(5*SGN(BZ)):ENDPROC
560 DEFPROCrun:PROCwipe(xZ,yZ):xZ=x
Z+BZ:PROCassass:ENDPROC
570 DEFPROCfire:IFAZ=0AZ=RND(5)+5
580 colX=SGN(2-(RND(5)-1))*16:IFABS
((yZ+colX)-480)>306colX=0
590 PROCwipe(xZ,yZ):yZ=yZ+colX:PROC
assass:SOUND&10,2,6,4:FORcolX=4TO0STE
P-4:MOVEXZ+32+(SGN(BZ)*32),yZ-28:GCOL
3,5:PLOT1,SGN(BZ)*640,0:PROCdelay(col
X):NEXT:IFABS((yZ-26)-(YZ-32))<32PROC
hit
600 AZ=AZ-1:IFAZ=0BZ=-BZ:spare1X=sp
are1X-(SGN(BZ)*40)
610 ENDPROC
620 DEFPROCgameover:PROCdelay(70):S
OUND17,5,230,91:SOUND16,-15,7,91:IFme
nX=-2VDU4:COLOUR0:FORcolX=9TO16:PRIN
TTAB(colX,5);CHR$250:NEXT:VDU5
630 FORcolX=1TO90:MOVEXZ+32,YZ-32:R
EPEAT:varX=RND(3):UNTILvarX<2:GCOL0,
varX:DRAWNRND(1000),RND(1000):NEXT:PRO
Cdelay(425):ENDPROC

```

Villains listing

From Page 161

```
640 DEFPROCman:VDU25,4,XZ;YZ;18,0,7
,234+(5*S6N(CZ)),8,18,0,1,235+(5*S6N(CZ)),8,18,0,3,236+(5*S6N(CZ)),8,18,0,4,237+(5*S6N(CZ)),10,8,18,0,1,238+(5*S6N(CZ)):ENDPROC
```

```
650 DEFPROCbar:IFgoldZ(printZ)=060T
0660ELSEVDU25,4,goldposZ(printZ,1);go
ldposZ(printZ,2);18,0,8,251,8,18,0,15
,252
```

```
660 printZ=printZ+1:IFprintZ=5print
Z=1
```

```
670 ENDPROC
```

```
680 DEFPROCchugo:BX=1:AZ=hugoZ:VZ=16
:colZ=RND(2):IFcolZ=1xZ=150ELSExZ=106
6
```

```
690 IFYZ>=450yZ=YZ-(RND(3)*75)ELSEy
Z=YZ+(RND(3)*75)
```

```
700 REPEAT:IFAZ>0AZ=AZ-1ELSEAZ=-1:V
Z=S6N(YZ-yZ)*40
```

```
710 PROCmovehugo:IFBZ>0PROCkey
```

```
720 UNTILBZ=0OR RZ=0:PROCwipe(xZ,yZ)
:IFBZ=0ANDspeedZ>4speedZ=speedZ-7
```

```
730 IFRZ=0scoreZ=scoreZ+50:killedZ=
killedZ-1
```

```
740 ENDPROC
```

```
750 DEFPROCmovehugo:IFAZ>0VZ=-VZ
```

```
760 IFABS((YZ-32)-(yZ-32))<32ANDAZ<
=0PROCchugofire
```

```
770 PROCwipe(xZ,yZ):yZ=yZ+VZ:VDU25,
4,xZ;yZ;18,0,7,249,8,18,0,4,255,8,18,
0,1,246,10,8,18,0,4,247,8,18,0,1,248:
ENDPROC
```

```
780 DEFPROCchugofire:SOUND&10,0,0,5:
SOUND&11,3,200,10:FORcolZ=12TO0STEP-1
2:VDU25,4,xZ+32;yZ-32;25,4,XZ;YZ+10;:
6COL3,2:PLOT85,XZ,YZ-74:PROCdelay(col
Z):NEXT:BZ=0:ENDPROC
```

```
790 DEFPROCwave:XZ=640:YZ=448:waveZ
=waveZ+1:killedZ=13+(waveZ*2):CL6:MOV
E450,700:6COL0,RND(6):PRINT"WAVE ";wa
veZ:MOVE370,600:PRINT"COMPLETED":UZ=0
:FORcolZ=1TO4:IFgoldZ(colZ)=1 UZ=UZ+1
```

```
800 IFhugoZ>0hugoZ=hugoZ-2
```

```
810 NEXT:MOVE370,500:PRINT"BONUS x
";UZ:scoreZ=scoreZ+(RND(4)*100*UZ):FO
RcolZ=1TOUZ:MOVE365+(colZ*100),400:VD
U18,0,8,251,8,18,0,15,252:NEXT:IFdist
Z>40distZ=distZ-40
```

```
820 IF(waveZ/3)=INT(waveZ/3)ANDmenZ
<7 6COL0,12:MOVE400,300:PRINT"+ ENER6
Y":menZ=7:speedZ=32:VDU4:COLOUR1:FORc
olZ=9TO16:PROCdelay(5):PRINTTAB(colZ,
5);CHR$250:NEXT:VDU5
```

```
830 PROCdelay(500):CL6:PROCman:PROC
bars:ENDPROC
```

```
840 DEFPROCscore:VDU4:COLOUR1:PRINT
TAB(9,2);scoreZ:VDU5:ENDPROC
```

```
850 DEFPROCbars:FORcolZ=1TO4:IFgold
```



```
Z(colZ)=1VDU25,4,goldposZ(colZ,1);gol
dposZ(colZ,2);18,0,8,251,8,18,0,15,25
2
```

```
860 NEXT:ENDPROC
```

```
870 DEFPROCchitable
```

```
880 *FX15,0
```

```
890 VDU23;8202;0;0;0;:IFscoreZ<HIZ(
5) 60TO950
```

```
900 UZ=0:REPEAT:UZ=UZ+1:UNTILscoreZ
>=HIZ(UZ)
```

```
910 IFUZ=5 60TO930
```

```
920 FORcolZ=5TO UZSTEP-1:HIZ(colZ)=
HIZ(colZ-1):HI$(colZ)=HI$(colZ-1):NEX
T
```

```
930 HIZ(UZ)=scoreZ:PRINT"CHR$130"YO
U ARE RANKED NUMBER ";UZ;"CHR$129"WE
LL DONE!":INPUT"PLEASE TYPE IN YOUR
NAME..",A$:IFLEN(A$)>8 A$=LEFT$(A$,8
)
```

```
940 HI$(UZ)=A$
```

```
950 CLS:A$=CHR$132+CHR$157+CHR$129+
CHR$141+CHR$130+" VILLAINS HALL O
F FAME":PRINTTAB(0,3);A$;TAB(0,4);A$
```

```
960 FORcolZ=1TO5:PRINTTAB(9,colZ+8)
;CHR$(128+RND(6));HIZ(colZ);STRING$(2
0-(LEN(HI$(colZ))+LEN(STR$(HIZ(colZ)
))),".");HI$(colZ):NEXT:PRINTTAB(9,17)
;CHR$133"Another Game? (Y/N)"
```

```
970 A$=GET$:IFINSTR("YyNn",A$)=0VDU
7:60TO970
```

```
980 CLS:IFA$="N" OR A$="n"END ELSE
ENDPROC
```

```
990 DEFPROCwipe(aZ,bZ):VDU25,4,aZ;b
Z;18,0,0,250,10,8,250:ENDPROC
```

```
1000 PROCgameover:MODE7:PROCchitable:
PROCinstruct:MODE2:VDU23;8202;0;0;0;:
VDU5:PROCvar:PROCscreensetup:RETURN
```

```
1010 DEFPROCinstruct:A$=CHR$132+CHR
$157+CHR$129+CHR$141+CHR$130+"
```

```
VILLAINS":PRINTTAB(0,3);A$;TAB(0,
4);A$;TAB(15,6)CHR$129"KEYS:";TAB(13
,10)CHR$133"Z...LEFT";TAB(13,12)CHR$
133"X...RIGHT"
```

```
1015 PRINTTAB(13,14)CHR$133"+...UP"
;TAB(13,16)CHR$133">...DOWN"
```

```
1020 PRINTTAB(13,18)CHR$133"<SPACE>
...FIRE";TAB(7,21)CHR$129;CHR$136"PR
ESS <SPACE> TO START":REPEATUNTILGET
$=" ":ENDPROC
```

```
1030 DEFPROCerr:IFERR<>17 REPORT:PRI
NT" at line ";ERL:END
```

```
1040 ENDPROC
```

```
1050 DEFPROCinit:DIMgoldZ(4),goldpos
Z(4,2),xposZ(2),yposZ(2),HIZ(5),HI$(5
):FORcolZ=2TO5:HI$(colZ)="DBT":HIZ(co
lZ)=1000::NEXT:HI$(1)="DEREKDBT":HIZ(
1)=10000
```

```
1060 VDU23,224,96,176,96,32,48,120,8
8,24,23,225,0,64,0,0,0,0,0,23,226,0
,0,0,0,0,166,227,23,227,48,48,112,9
6,96,96,224,23,228,64,8,12,6,3,1,1
,0,23,229,14,31,31,14,0,0,0,8,23,230,
0,0,0,0,4,12,14,0,23,231,0,0,0,0,0,3,
1,7
```

```
1070 VDU23,232,0,0,0,0,0,240,16,23
,233,14,26,50,34,34,34,34,230,23,234,
6,13,6,4,12,30,26,24,23,235,0,2,0,0,0
,0,0,0,23,236,0,0,0,0,0,101,199,23,
237,12,12,14,6,6,6,6,7,23,238,2,16,48
,96,192,128,128,0,23,239,112,248,248,
112,0,0,0,16
```

```
1080 VDU23,240,0,0,0,0,32,48,112,0,2
3,241,0,0,0,0,0,192,128,224,23,242,0,
0,0,0,0,15,8,23,243,112,88,76,68,68
,68,68,103,23,244,62,127,0,0,0,8,28,2
8,23,245,0,0,42,62,28,0,0,0,23,246,0,
0,0,0,0,0,99,23,247,28,8,28,20,20,2
0,20,54
```

```
1090 VDU23,248,65,119,0,0,0,0,0,23
,249,28,62,42,62,28,0,0,0,23,250,255,
255,255,255,255,255,255,23,251,28
,20,28,0,0,0,0,0,23,252,0,8,0,0,0,0,0
,0,23,253,65,99,0,0,0,0,0,23,254,0,
0,0,20,20,20,20,54,23,255,0,0,20,0,0,
8,28,28
```

```
1100 ENVELOPE1,129,-15,-8,-3,10,10,1
0,126,0,0,-126,126,126:ENVELOPE2,1,0,
0,0,0,0,126,-1,0,-3,126,126:ENVELOP
E3,1,4,-4,4,2,4,2,127,0,0,-5,126,126:
ENVELOPE4,1,-1,0,0,145,0,0,10,0,0,-10
,10,0:ENVELOPE5,3,-1,0,0,150,0,0,10,0
,0,-10,10,0:ENDPROC
```

This listing is included in this month's cassette tape offer. See order form on Page 193.

HIGH QUALITY EDUCATIONAL SOFTWARE

Designed by teachers and programmed by experts for your BBC B 1.2 O.S.

COMPRENDS-TU? Fun packed exercises on two cassettes to improve French comprehension. Includes TU AS BIEN COMPRIS?, TROUVE LE VILAIN, TROUVE LA PHRASE CACHEE, LA GUILLOTINE and A TOI MAINTENANT which also allows you to enter, save, learn and randomly test your own vocabulary. Suitable for 13+ to adult. **£14.50**

UNDERSTANDING YOUR BBC MICRO With the aid of graphics, simple questions and program simulations, learn how your computer works and how to write programs. This package of two cassettes includes a nifty Reference Guide which gives you instant information on your screen about Basic Keywords. Suitable for 12+ to adult. **£14.50**

RAINY DAYS Stimulating word and memory games to keep your 9 to 14 year old usefully occupied for hours. **£7.50**

EARLY READING - BEDTIME TALES. Improve the reading skills and computer literacy of your 6 to 8 year old with these delightful interactive stories. **£9.50**

EARLY READING - ALPHABET SOUNDS. Provides essential practice for the 4 to 6 year old in recognising the sound of the first letter associated with the randomly presented picture and picking out that corresponding letter from a list. **£9.50**



PANDASOFT

Mere View House, Church Street,
Wincham, Cheshire CW9 6EP.

Prices include VAT and P&P

BASIC COMPILER

Available now for the BBC Micro.

A high performance compiler at a realistic price. Turns your Basic programs into super fast 6502 machine code. The compiler is very easy to use, and has the following features:

- Accepts over 50 Basic keywords
- Handles 26 integer variables
- Full integer arithmetic

The program is supplied on cassette with full instructions for 32K BBC Micro with 1.2 O.S.

Send cheques/PO's for £17.95 or S.A.E. for details to:

PARK SOFTWARE

26 Romilly Park Road, Barry, S.G.lam., CF6 8RQ

SUMMER SALE OF AGB COLOUR MONITORS

with cable for BBC Micro

Unrepeatable offer on metal cased units with full manufacturers' warranty.

14" model £180
20" model £250
14" High Res. model £280

(very limited quantities only)

Also 12" High Res. green screen mono monitors at £89

VISION PRODUCTS, 9 CLAYMILL RD., LEICESTER. Tel: 352501
(SAE for leaflet — special terms for Education Users)

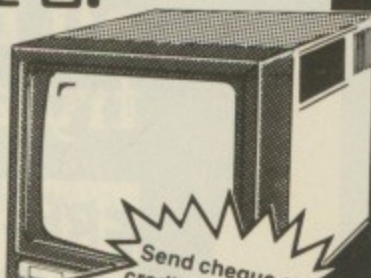

Send cheque or credit card number and allow 10 days for delivery

COMPUTER GARDENING PROGRAMS

Two amazing programs for your BBC Model B computer

GREENFINGER:GARDEN PLANT SELECTOR

Give your BBC Model B access to information on over 400 plants. You tell the computer about growing site conditions - soil type, sunlight, moisture. The computer finds the best plants for you. Plant descriptions, flowering time, growing conditions, propagation methods etc., appear on your TV screen.

GREENFINGER:GARDEN LAYOUT PLANNER

Design your garden layout with your BBC Model B. Build up a computer model of your garden layout. Position buildings, walls, paths, patios, borders, flower beds, greenhouses, trees and shrubs. The computer plots a scaled plan on your TV complete with areas of shade! Add and delete items, pan around the layout, file and retrieve your layout for future use. Save on expensive garden purchases and building work!

Programs supplied on cassette tapes with full instructions. Each program costs £12.95 inc. P & P. Send cheque with order and name and address (BLOCK CAPITALS) to:

Cambridge Applied Technology, 51 Hinton Road, Fulbourn, Cambridge CB1 5DZ.

Also available from W.H.SMITH & SONS LIMITED



TOP SAVINGS

	EX VAT	INC VAT
PRINTERS		
BROTHER HR 15	329.00	379.65
TRACTOR	62.00	71.30
SHEETFEEDER	185.00	212.75
KEYBOARD	135.00	155.25
EPSON RX80T	195	224.25
EPSON RX80F/T	220	253.00
EPSON FX80F/T	324.00	372.60
EPSON FX100F/T	430.00	494.50
EPSON RX100F/T	350.00	402.50
FX80 TRACTOR	30.00	34.50
JUKI 6100	325.00	373.75
MANNESMANN TALLY MT 80	199.00	228.85
NEC 2050 (IBM PC)	725.00	833.75
OKI MICROLINE 82A	255.00	293.25
OKI MICROLINE 83A	395.00	454.25
OKI MICROLINE 92P	379.00	435.85
SEIKOSHA GP100A	165.00	189.75
SHINWA CP80	175.00	201.25
STAR GEMINI 10X	199.00	228.85
STAR DELTA 10	329.00	378.35
COMPUTERS		
COMMODORE 64	152.17	174.99
COMMODORE 1541 DISK	165.21	189.99
COMMODORE C2N CASSETTE	32.00	36.80
INTERFACE 64-PAREL	59.50	68.43
APRICOT 2*D+MON	1425	1638.75
APRICOT 10MB	2295	2639.25
SANYO MBC555	795	914.25
SANYO MBC550	695.00	799.25
EPSON QX10	1600.00	1840.00

MAYFAIR MICROS

Blenheim House, Podmore Road, London
SW18 1AJ. Tel: 01-870 3255

DUCKWORTH HOME COMPUTING

EXPLORING ADVENTURES ON THE BBC MODEL B

by Peter Gerrard £6.95

This is a complete look at the fabulous world of Adventure Games for the BBC Computer. Starting with an introduction to adventures, and their early history, it takes you gently through the basic programming necessary on the BBC before you can start writing your own games.

Inputting information, room mapping, movement, vocabulary - everything required to write an adventure game is explored in detail. There follow a number of adventure scenarios, just to get you started, and finally three complete listings written specially for the BBC, which will send you off into wonderful worlds where almost anything can happen.

The three games listed in this book are available on one cassette.

BBC PROGRAMS 1

Edited by Nick Hampshire

This book provides you with a range of useful and exciting programs for the BBC Micro. Games, utilities, graphics and functional programs are covered. The games include an exciting version of Star Trek, a full length adventure game, Space Invaders, Battleships, Space Blaster, Brick Basher, and many others. Among the functional programs is a personal information retrieval package which enables you to create and manipulate up to 365 records. This is a basic book for every user of the BBC Micro.

Written by Carl Graham and edited by Nick Hampshire, publisher of *Commodore Computing International*. £6.95

Write in for a catalogue.



DUCKWORTH

The Old Piano Factory, 43 Gloucester Crescent, London NW1 7DY
Tel: 01-485 3484

After FOUR
user-packed shows
we are moving
back to the North!

Get ready for the FI

UMIST, Manchester, Friday August 31 to S

**OFFERS
GALORE**

Everything on display at the show will be for sale – often at special low show prices. So you'll easily be able to save much more than your admission ticket in your first five minutes at the show!

This is where it all began!



It was here, in June, 1983, that we held our first show, and it attracted 12,500 enthusiastic BBC Micro fans. The UMIST building is only five minutes from British Rail's Piccadilly main line station – and there is plenty of parking space available on the campus. In fact, it's an ideal conference location.

**Hundreds of
new games,
educational
and business
programs, plus
all the latest
hardware
add-ons for the
BBC Micro and
Electron – and
all for you to
try and buy.**



EXHIBITORS INCLUDE

Acom Computers, Advanced Memory Systems, Aries Computers, Bucon, Cambridge Micro-processor Services, Clares Micro Supplies, Clwyd Technics, Computer Concepts, Com-soft, Cumana, Dynabyte Software, Enterprise Technology Computing, Feedback Instruments, Golem, HCR Electronic Sales, Holiday Brothers, Kansas City Systems, M.P. Software and Services, MRM Software, M.T. Direct, Mr Floppy, Manchester University Press, Micro-Aid, Micro-Aids, Micropower, Micro Simplex, Microware, Microvitec, NSC Computer Shops, National Micro Centres, News-soft, Opus Supplies, Pace Software Supplies, Specialised Education Software and Services, System, Universal Communications, Video Electronics, Viglen Computers, Wise-Owl Publications, Wizard Development.

the **FIFTH** great...

at 31) Sunday September 2

You'll find all the answers to your problems at our

Walk-in Forum

We are bringing back the much talked-about feature of our first Manchester show.

Throughout the weekend some of Britain's top experts on the BBC Micro and Electron will be making guest appearances at the forum, held in a lecture theatre adjoining the two exhibition halls.

Whether you're a beginner or an experienced user, they will be delighted to answer all your questions.

On sale will be

BBC Micros, Electrons, Teletext adapters, Torch disc packs, BBC Buggies, Second Processors, ROM Expansion Boards, Grafpads, Books, Joysticks, Interfaces, Disc drives, Data recorders, Lightpens, Modems, Speech Synthesisers, Carrying Cases, Cables, Digitizers, VDU stands, Graphics tablets, ROM chips, Monitors, Printers . . .

PLUS many thousands of software programs - games, educational and business packages.



Reduced prices for School/College Groups

Entry only £1 per student if bookings are made in advance. Send your cheque (made payable to Database Publications) and SAE to:

Electron & BBC Micro User Show
68 Chester Road, Hazel Grove
Stockport SK7 5NY Tel: 061-456 8383

Valid for a minimum of 10 people

SAVE MONEY with our Special Travel Offer

Visitors to the Show can obtain cut-price rail tickets from ANY station in the United Kingdom

For full details write to:

Travel Offer, P.O. Box 1, St. Albans AL1 4ED with SAE or Telephone: St. Albans 34475 quoting: The Electron & BBC Micro User Show.

This voucher is worth 50p per head



By handing in this voucher at the door you save 50p off the normal admission price of £2 (adults) and £1.50 (children).

(Valid for a maximum of 4 people)

10am - 6pm, Friday, 31 August
10am - 6pm, Saturday, 1 September
10am - 4pm, Sunday, 2 September

Renold Building, UMIST, Manchester.

Number attending: 1 2 3 4

The Aries File

CRUSHED BETWEEN AN IRRESISTIBLE FORCE AND AN IMMOVABLE OBJECT?

If your high-resolution screen is squeezing you from one side, and your operating system from the other, isn't it time you tried the ARIES solution? ARIES-B20 is the board which banishes forever the conflict between screen graphics and program memory. "bad mode" and "No room" become nightmares of the past when your Beeb possesses this unique expansion.

Unlike "sideways-RAM" systems, ARIES-B20 offers you *transparent* access to 20K of extra memory, replacing the RAM swallowed up by the high-resolution graphics modes. The extra RAM is switched in completely automatically, meaning that your existing software can make use of it *without modification*.

This means that if you're a programmer, you have up to 28K RAM available for BASIC, FORTH, LISP, BCPL, LOGO and COMAL programs in *ANY SCREEN MODE*. If you're a business user, the extra memory is used by

VIEW, VIEWSHEET, WORDWISE and many other applications. And if you're a scientific type, you can get access to a massive 47K of data storage using the Acorn-approved ARIES ★FX call.

COMPATIBILITY ASSURED

With the huge range of Beeb add-ons that are becoming available, compatibility has become a real headache. Every extra you buy your computer might lock you out from a host of others, even if it works with those you already possess.

ARIES-B20, designed by BBC Micro experts, offers you true upgradeability. In addition to the rest of the ARIES family (the ARIES-B12 ROM expansion board and the ARIES-B488 IEEE-488 interface unit), ARIES-B20 is compatible with double-density disc controllers, second processors, ECONET, hard discs, EPROM programmers and

much more. Several major companies now test all their products with ARIES-B20 to ensure compatibility.

PROFESSIONAL QUALITY

The ARIES range is designed to work with *all* BBC Micros, not just some of them. This means it has a sensible regard for the capacity of the power supply and the natural variations in critical timings between machines. All new ARIES products are subjected to brutal testing in extreme conditions before they are released on the market.

In quality of construction, the ARIES range sets a standard against which others are judged. Custom-made connectors eliminate the damage to the BBC machine caused by inferior products. Units are electronically tested before, during and after manufacture. And all this is backed up by the ARIES 1 year no quibble guarantee.

WHAT THE PRESS SAID

"the most exciting add-on"
- Times Educational Supplement, March 1984

"a very professional product"
- A & B Computing, March/April 1984

"an attractive solution to the lack of sufficient memory on the Beeb"
- Beebug, March 1984

"this is an impressive piece of equipment in its own right and deserves to be taken seriously"
- Acorn User, April 1984

"the trouble with a paged RAM system is that the software has to be aware that it is there. The Aries RAM board gets round this limitation brilliantly"
- The Micro User, June 1984

NOW AVAILABLE THROUGH DEALERS

To cope with the continuing growth of demand, the unique ARIES-B20 RAM expansion has now been made available through selected dealers. Although ARIES-B20 can be fitted by a complete layman in a matter of minutes, a fitting service is offered by approved dealers to those customers unwilling to delve inside the case of their BBC Micro.

The recommended retail price of ARIES-B20 is just £115 (inc VAT) for the B20 board, operating system extension ROM and detailed manual. Enquire at your local dealer or order direct by post from the Manufacturers (see below).

(Machine requirements: Model 'B', MOS 1.2. Hardware plugs into CPU socket, software uses one sideways ROM socket)

How to order:

Send cheque or postal order made payable to:
Aries Computers
and forward to:

Aries Computers
Science Park, Milton Road,
Cambridge CB4 4BH
Telephone Cambridge (0223) 862614

Please send me (Qty.) ARIES-B20(s) at £115.00
(incl. P.P. & VAT)
I enclose a cheque/postal order made payable to
Aries Computers for £.
Signed
Name (block letters)
Address
Post Code.

ALL IN STOCK

Acorn Ele
BBC Mic
CP80 Pri
Disc Ope
Disc Driv
Disc Ope
G3 WH
G3 WH
Circuit b
Star 10
CANN
Joystick
Print
Spee
Disc
WORD
Slow S

Wide selection
SAE for full li
48 Linby R
Notts. NG
Tel: 0602

£6
inc. P&P

YES

These
Drives
Sing
Disc
p&p

ALL IN STOCK

S.P. ELECTRONICS

BBC SPECIALISTS

Acorn Electron	£199.00
BBC Model B 1.2 O.S.	£399.00
CP80 Printer (inc. cable)	£229.00
Disc Operating System	£96.00
Disc Drives	from £175.00
Disc Operating System D-Density	£104.00
G3 WHO RTTY PROGRAM (TAPE)	£7.50
G3 WHO RTTY PROGRAM (EPROM VERSION)	£20.00
Circuit board for RTTY decoder Mk.3 (inc. instructions)	£7.00
Star 10X Printer (inc. cable)	£275.00
CANNON Dot Matrix 160cps NLQ	£350.00
Joysticks (pair) self centering + analogue	from £17.95
Printer Cable (Centronics)	£12.90
Speech Synthesis	£55.00
Disc Doctor	£33.00
WORDWISE Word Processor	£39.00
Slow Scan TV Circuit Board + Program (inc. instructions)	£17.50

Wide selection of software, books, leads, plugs, etc. All prices apply while stocks last.
 SAE for full list. All available Mail Order
48 Linby Road, Hucknall, Notts. NG15 7TS.
 Tel: 0602 640377

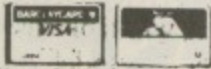

Carriage extra

(all prices include VAT)



inc. P&P

32k BBC MICRO ANTI-AIRCRAFT GUN SIMULATOR

NOW WITH

!!FREEZE FRAME OPTION!!



inc. P&P



SCREEN DIAGRAM

- * 100% Machine Code
- * Hi-Speed Graphics
- * Three winning score levels
- * Sound on/off option during play
- * Long range radar screen
- * Scrolling, scenery
- * Keys or joystick
- * Freeze frame
- * Re-set option

All P.O. orders sent by return, cheques 7 days.

CHALLENGING—FRUSTRATING—FUN

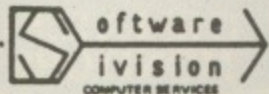

7 OBRIDGE ROAD, TAUNTON SOMERSET TA2 7PX

BANANA COMPUTERS LIMITED

YES PEOPLE ARE GOING APE OVER OUR DISC DRIVES

(Compatible with BBC MICRO)

£80 inc p&p

These Tandon TM50-1, Single Sided, 40 track 100K, 5 1/4" Slimline Disk Drives are supplied uncased at the remarkable price of £80 inc. p&p

Single Drive Cases £12 inc. p&p

Disc box of ten Double sided, Double density with library box £20 inc. p&p (limited quantity)

Send remittance (Cheque only please) with your order to:

BANANA COMPUTERS LTD.
 P.O. BOX 193
 HISTON
 CAMBRIDGE CB4 4JN
 Please allow 28 days for delivery.

J.P. MAGNETICS LIMITED

HAVING TROUBLE OBTAINING QUALITY COMPUTER LENGTH CASSETTES?

WE CAN SOLVE YOUR PROBLEM

10 x C15 for £4.50 + 50p P&P

(CASH WITH ORDER)

We are specialists in the supply of bulk custom wound audio/computer cassettes.

Trade and Educational Enquiries Welcome.

Competitive Rates - Price List Available.

Contact us now: (0274) 731651

Unit 4, - 7 Mary Street, Bradford, BD4 8SW.

LARGEST COMPUTER CENTRE

in

MANCHESTER

BBC, COMMODORE, MEMOTECH, SINCLAIR, SHARP, SANYO DEALERS

AMSTRAD IN STOCK

BBC MICRO

BBC B (Free Recorder & Games)	£399
Electron	£199
6502 Second Processor	£199
Z80 Second Processor	£299
Bitstick System	£374

PRINTERS

Shinwa CP80 CTI	£219
Olivetti JP101	£155
Star Gemini 10X	£229
Juki 6100	£388
Epson RX80 FT	£289
Cannon 1080	£339

DISK DRIVES

Opus, Pace, Cumana

MONITORS

Sanyo 12N	£89
Philips	£89
Microvitec	£229
Sanyo Medium	£227
Fidelity	£217
JVC Medium	£199
JVC High	£272

ACCESSORIES

Wordwise	£39.95
VIEW	£59.95
Grafpad	£143.75
Sideways ROM	£45
Graphics ROM	£33
Disc Doctor	£33

COMPUTER STATIONERY, DISKS, PLUGS, SOCKETS, CABLES, ETC.
 TELEPHONE ANSWERING MACHINES/CORDLESS PHONES: NOW IN STOCK

Wide range of books, software (educational software specialist).
 Showroom, demonstration facility. Prices include VAT, all items available mail order. Personal Export scheme.

Suppliers to Universities and all leading Schools



MIGHTY MICRO



SHERWOOD CENTRE
 268 WILMSLOW ROAD
 FALLOWFIELD, MANCHESTER
 TEL: 061-224 8117

D.A. COMPUTERS LTD.

BBC ACORN COMPUTERS IN LEICESTER

Specialists in hardware and software.
 Fully authorised ACORN-BBC Dealer.

Complete after sales service - repairs and maintenance contracts.

Two of the most useful utilities for the serious BBC User.

SCREEN DUMP ROM This 8K page ROM will print out any graphics screen (as used for all Micro User screen dumps) (except mode 7) upright or sideways, x1, x2 or x4 scale on a variety of matrix printers including Epson, Shinwa, Star, NEC, Seikoshia, KDC, etc. It will also substitute up to eight shades of grey to represent screen colours. Mode 7 text and graphics can be printed on the FX80 or FX100 only (e.g. teletext screens). This Machine Code software will give you the fastest print out possible on your printer. Page ROM software means you have all the RAM available for your own programmes. Full documentation provided. £20.00

MACHINE CODE MONITOR ROM

Provides powerful facilities for monitoring and debugging machine code and BASIC programmes. Includes single step, break points, disassembler, memory scan "window", search for string or byte sequence, memory move, etc. Also provides BASIC program search and list variables. Extensive documentation. £20.00

BBC Model A and B Microcomputers and Electrons always in stock

PRINTERS	BROTHER/HR15 (Daisywheel)	£412.00
	EPSON FX80 Printers at	£392.00
	EPSON RX80F/T Printers at	£259.00
	SHINWA CP80 Printers at	£228.85
	KDC LOGITEC Printers at	£254.99
	CANON PW1080A	£318.99
MONITORS	MICROVITEC 14" COLOUR - ST. RES. at	£228.85
	MICROVITEC 14" COLOUR - MED. RES. at	£343.85
	MICROVITEC 14" COLOUR-HIGH RES. at	£503.70
	TECO 12" GREEN SCREEN (18MHz Bandwidth)	£107.00
	PHILIPS 12" GREEN SCREEN	£71.30
DISC DRIVES	Single Teac 100K	£149.95
	Single Mitsubishi 400K	£214.00
	Single Mitsubishi 40/80 switchable	£228.99
	Dual Mitsubishi 800K	£409.00
	Dual Mitsubishi 40/80 switchable	£439.00

Also a wide range of Books, Software and accessories for the BBC micro.

All our prices include V.A.T. - but add £5.00 carriage for heavy items (Printers, Monitors etc.)

Please call and visit our showroom at:-

D.A. Computers Ltd,
104, London Rd., Leicester.

(5 minutes walk from railway station).

Tel. (0533) 549407

We close all day Monday and Sunday otherwise open 9am to 5pm.

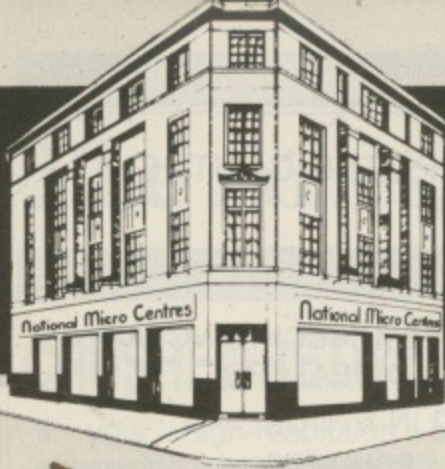

National Micro

**We bring you the best
of both worlds...**

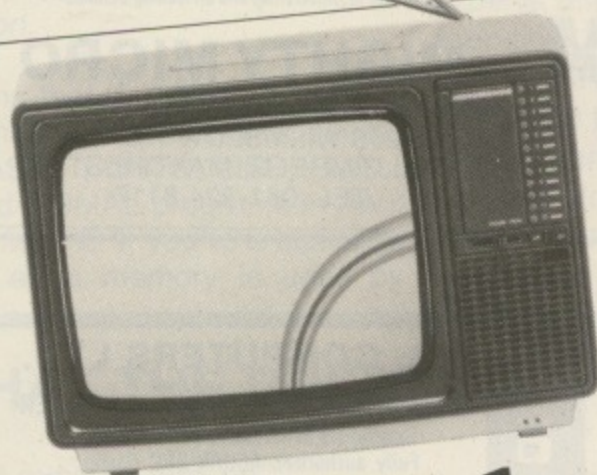

**for only
£206.96**

**...a combined portable TV
and RGB colour monitor**

Here's an ideal answer to arguments about who should use the home TV set. The superbly engineered 14 inch Nordmende has been specially designed for use both as a monitor and a domestic television. Linked to your BBC Micro, it gives the crispest possible reproduction of the BBC's colourful graphics, making it ideal

for playing arcade games. And you can also use it as a portable TV, giving you maximum mobility. Yet the price is less than for many comparable colour monitors - and you get an RGB connecting lead for your BBC Micro as well.

Other monitors available include

Zenith 12" Green Screen	£70.44
Microvitec 14" Colour low-res	£189.05
Microvitec 14" Colour med-res	£284.50
Microvitec 14" Colour hi-res	£418.60

LOW-COST PRINTERS

We have selected three of the most popular dot matrix printers. All allow you to condense or embolden text, offer high definition characters and allow you to produce clear-cut graphics and charts.

Brother HP5 (30cps)	£148.62
Epson RX80 (100 cps)	£236.52
RX80FT (incl. friction feed)	£273.91

For superb correspondence-quality printing you really need a daisywheel printer. Our choice, one of our top sellers, can also be used as a superior standalone electronic typewriter.

Silver Reed EX43 With special BBC interface	£342.83
Without BBC interface	£249.48

THE LATEST MONITORS

You can happily operate your BBC Micro with a domestic TV set. But more and more users are finding that for a really crisp picture you need a colour monitor. We offer a monochrome and three colour monitors.

Zenith 12" green screen	£70.44
Microvitec 14" colour - low-res ...	£189.05
14" colour - med-res	£284.50
14" colour - hi-res	£418.00

For the best of both worlds we recommend this 14" set which doubles as both a monitor and a normal TV set.

Nordmende With BBC lead	£206.96
With remote control and BBC lead	£218.26

Speed your games with a joystick

Sureshot: A really high quality joystick for the BBC Micro.

- ★ Self centering action.
- ★ Two fire buttons.
- ★ Rugged construction

£16.50

Wide DISC

We only sell that are ca interference

AMS 3" d
AMS-3(S)
AMS-3(T) 2

Cumana s
CSX 100 si
CSX 200 si
CSX 400 si
CS 100 sin
CS 100E si
CS 200 sin
CS 200E si
CS 400 sin
CS 400E si
CD 200 du
CD 400 du
CD 800 du
CD 400S-
switchab
CD 800S-
switchab

New LOW

Pace slin

PSD1 100
PSD2 200
PSD3 400
track, su
PSD4 400
(80 trac
PSD5 200
switcha
PDD2 40
(40 trac
PDD3 80
track, s
PDD4 do
track)
PDD5 do
track)

Each dri
blank dis
II - the b
enables y
programs

Se

de

Casse

Acomso
Collector
Database
Desk Dia
Forecast
Members
Personal
Manag
View Prin
BBC Se
Home Fi
Record H
Diamon
Business
Flexfile
Home A
Gemin
Cashbo

All
by

UK's LOWEST PRINTER PRICES !

PRINTERLAND



ORDERED TODAY - DELIVERED TOMORROW

DOT-MATRIX

EPSON RX 80	£189.95
EPSON RX 80 F/T	£219.00
EPSON RX100	£329.00
EPSON FX 80	£317.00
EPSON FX100	£425.00

DOT MATRIX PLUS NEAR-LETTER QUALITY

CANON PW1080A	£249.00
---------------	---------

DAISY-WHEEL

JUKI 6100	£325.00
EPSON DX100	£356.00

ACCESSORIES

WORDWISE	£32.00
PAPER (2000 Sheets)	£12.00
BBC/PRINTER CABLE	£10.95

COPYALL DISK

- Copies ALL protected disks inc. tape to disk utilities.
- Best on the market
- Copies from original to your blank disk

£10.25

Educational, G'ment plus O'seas Orders Welcome
Please add 15% VAT. Delivery Printers £10.00. Paper £3.00. Other 50p
Printerland, Unit 27, Estate Buildings, Railway St., Huddersfield HD1 1JP

TEL (0484) 514105

EPROM PROGRAMMER FOR THE BBC

A very high quality product direct from the manufacturers, contained in attractive sloping box with low insertion force socket and neon indicator for programming fitted as standard, the software adopts the high efficiency method for programming 2764 and 27128. This allows up to 100% faster programming, software in machine code, supplied on cassette and can be placed in eprom. Very easy to use, menu driven with easy to use instructions. This unit is completely self contained with its own power supply and plugs into the user port.

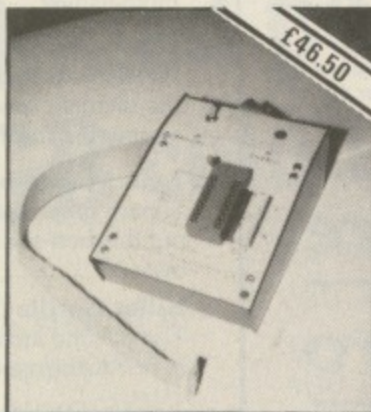

THIS PROFESSIONAL UNIT ALLOWS:

1. Will program: 2716, 2732, 2532, 2764 and 27128 eproms.
2. Copy eprom into memory and compute checksum.
3. Blank check eprom.
4. Program eprom from memory.
5. Verify byte by byte and compute checksum.
6. allow buffer start area to be changed.
7. All operating system calls may be used when in menu mode.
8. Semi-intelligent programming. Typical time to program a 2764 8k device is approx. 50 sec. depending on the data to be programmed.
9. Additional software supplied to enable your own program (basic or machine code) to be put into eprom with the necessary leader information to allow calling with a *command. Downshift routine to enable basic programs to be run is also supplied.

COST £46.50 please add 15% VAT £1.00 post and package

Also available: RAM/ROM card 16 socket - details on request.

ORDERS TO:

H.C.R. ELECTRONICS, Industrial Unit,
Parker Road, Chelmsford, Essex CM2 0ES.
Access Orders Phone:
Chelmsford (0245) 350188 24 hours



061-456 4157

... that's the number you'll need for Microweb, the most exciting bulletin board around for the BBC Micro.

On Microweb you can browse through the hundreds of fascinating messages left by other users, and add your own contributions - you'll be amazed by the number of interesting people you'll come across on the board.

You can have your programming problems answered by experts, download software, and catch up with the latest news.

In the few weeks it's been in existence it has become the ultimate forum for all BBC Micro users.

So if you want to join in the liveliest conversation ever between BBC Micro enthusiasts why not log on? We'll be glad to hear from you. All you have to do is dial in via a 300 baud modem with suitable software.

And if you're looking for the kit to get you started, why not try Pace's Commstar/modem combination?



AS Microweb has proved, communications is the fastest growing field in microcomputing, and we want YOU to be involved.

So we're offering a unique starter pack - the superb Commstar/modem combination from Pace. And it costs just £139.95.

Commstar will turn your micro into a versatile terminal that will allow you to access micros, mainframes, viewdata systems and bulletin boards - including Microweb and Prestel.

The modem is ideal for making use of Commstar's many exciting facilities, and with its push button controls it couldn't be easier to use.

At the Micro User we're very impressed with this matched pair, and we're sure you will be too.

FREE!

8 weeks' introductory membership of Prestel/Micronet will be given to all readers whose orders are postmarked before October 1, 1984.

Please send me _____ Communications packs at the total price of £139.95 each (includes VAT, post and packing).

I enclose a cheque/PO for £ _____ made payable to Database Publications Ltd.

I wish to pay by Access Visa

No. _____ expiry date _____

Signed _____

Name _____

Address _____

Post to: Communications Offer, Database Publications Ltd,
Europa House, 68 Chester Road, Hazel Grove, Stockport SK7 5NY.

Please allow 28 days for delivery

Micro Term listing

From Page 117

940 .check_for_e	1400 PLA	1890 .check_xon_x	2380 LDA #inputbu	ck DIV 256
nd	1410 BNE on	off	ffer MOD 256	2740 LDA operand
950 LDA buffpoin	1420 .off	1900 JSR getchar	2390 STA filebloc	2750 PHA
tl	1430 LDA bufferof	1910 BCS endcheck	k	2760 JSR OSFILE
960 CMP bufftopl	f,Y	1920 .char_receiv	2400 STA paramblo	2770 PLA
970 LDA buffpoin	1440 JSR OSASCI	ed	ck	2780 BEQ out
th	1450 INY	1930 CMP #17	2410 LDA #inputbu	2790 LDA buffstar
980 SBC bufftoph	1460 CMP #13	1940 BNE xoff	ffer DIV 256	tl
990 RTS	1470 BNE off	1950 LDX #0	2420 STA filebloc	2800 CLC
1000 .storechar	1480 SEC	1960 STX xon_xoff	k+1	2810 ADC filebloc
1010 LDY #0	1490 RTS	_status	2430 STA paramblo	k+10
1020 STA (bufftop	1500 .on	1970 .xoff	ck+1	2820 STA bufftopl
l),Y	1510 LDA bufferon	1980 CMP #19	2440 LDA #18	2830 LDA buffstar
1030 JSR incremen	,Y	1990 BNE nocode	2450 STA paramblo	th
t_store	1520 JSR OSASCI	2000 LDX #1	ck+2	2840 ADC filebloc
1040 RTS	1530 INY	2010 STX xon_xoff	2460 LDA #32	k+11
1050 .fetchchar	1540 CMP #13	_status	2470 STA paramblo	2850 STA bufftoph
1060 LDY #0	1550 BNE on	2020 .nocode	ck+3	2860.out
1070 LDA (buffpoi	1560 SEC	2030 JSR display	2480 LDA #127	2870 RTS
ntl),Y	1570 RTS	2040 .endcheck	2490 STA paramblo	2880 .inputbuffer
1080 PHA	1580 .fkey1 \ out	2050 LDX xon_xoff	ck+4	2890]
1090 JSR incremen	put buffer	_status	2500 LDX #parambl	2900 PZ=PZ+20
t_pointer	1590 JSR send_buf	2060 BNE check_xo	ock MOD 256	2910 [OPT optX
1100 PLA	fer	n_xoff	2510 LDY #parambl	2920 .fileblock
1110 RTS	1600 SEC	2070 JSR toRS423	ock DIV 256	2930]
1120 .keyboard_sc	1610 RTS	2080 JMP output_l	2520 LDA #0	2940 PZ=PZ+20
an	1620 .fkey2	oop	2530 JSR OSWORD	2950 [OPT optX
1130 LDA #145	1630 LDA #0	2090 .allsent	2540 .zeroblock	2960 .paramblock
1140 LDX #0	1640 STA operand	2100 RTS	2550 LDY #2	2970]
1150 LDY #0	1650 JMP filing	2110 .toRS423	2560 LDA #0	2980 PZ=PZ+6
1160 JSR OSBYTE	1660 .fkey3	2120 LDA #3	2570 .zeroloop	2990 [OPT optX
1170 BCS nokey	1670 LDA #&FF	2130 LDX #7	2580 STA filebloc	3000 .filename
1180 TYA	1680 STA operand	2140 JSR OSBYTE	k,Y	3010]
1190 CMP #128	1690 .filing	2150 RTS	2590 INY	3020 \$PZ="Filena
1200 BCC not_fkey	1700 JSR fileop	2160 .toscreen	2600 CPY #&12	e ?"
1210 BEQ fkey0	1710 LDA #7	2170 LDA #3	2610 BCC zeroloop	3030 PZ=PZ+LEN(\$P
1220 CMP #129	1720 JSR OSWRCH	2180 LDX #4	2620 LDA buffstar	X)+1
1230 BEQ fkey1	1730 SEC	2190 JSR OSBYTE	tl	3040[OPT optX
1240 CMP #130	1740 RTS	2200 RTS	2630 STA filebloc	3050 .bufferon
1250 BEQ fkey2	1750 .nokey	2210 .display	k+2	3060]
1260 CMP #131	1760 SEC	2220 PHA	2640 STA filebloc	3070 \$PZ="Buffer
1270 BEQ fkey3	1770 RTS	2230 JSR toscreen	k+10	On"
1280 SEC	1780 .send_buffer	2240 PLA	2650 LDA buffstar	3080 PZ=PZ+LEN(\$P
1290 RTS	1790 JSR toRS423	2250 JSR OSWRCH	th	X)+1
1300 .not_fkey	1800 LDA buffstar	2260 RTS	2660 STA filebloc	3090 [OPT optX
1310 CLC	tl	2270 .fileop	k+3	3100 .bufferoff
1320 RTS	1810 STA buffpoin	2280 JSR toscreen	k+11	3110]
1330 .fkey0 \ toq	tl	2290 LDA #12	2670 STA filebloc	3120 \$PZ="Buffer
gle copy to buffer	1820 LDA buffstar	2300 JSR OSWRCH	k+14	Off"
1340 LDA buffer_f	th	2310 LDY #0	2700 LDA bufftoph	3130 PZ=PZ+LEN(\$P
lag	1830 STA buffpoin	2320 .prompt	2710 STA filebloc	X)+1
1350 EOR #1	th	2330 LDA filename	k+15	3140 NEXT optX
1360 STA buffer_f	1840 .output_loop	,Y	2720 LDX #fileblo	3150 END
lag	1850 JSR wait	2340 JSR OSASCI	ck MOD 256	
1370 PHA	1860 JSRfetchchar	2350 INY	2730 LDY #fileblo	
1380 JSR toscreen	1870 BCS allsent	2360 CMP #13		
1390 LDY #0	1880 JSR OSWRCH	2370 BNE prompt		

This listing is included in this month's cassette tape offer. See order form on Page 193.

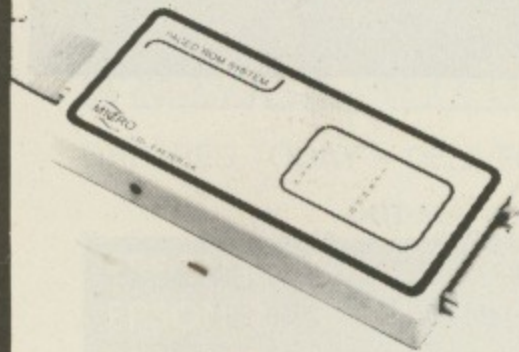

MICRO
EXTERNAL
SIDWAYS ROM
EXPANSION

- Sideways ROM expansion to 16 ROM's, all sockets software addressable.
- Unique two circuit board design requiring the minimum amount of space within the computer.
- System can be purchased for EXTERNAL or INTERNAL use with the BBC micro.
- External board mounted in a smart open based purpose built box, colour matched to the BBC micro.
- NO soldering, plug in design.
- Plugs into the CPU socket using IC socket compatible pinouts.
- Full instructions provided.
- Buffered minimising the loading on the computers internal circuitry.
- Minimal power consumption when board fully populated.
- Fully compatible with all ROM's/EPROM's.

AVAILABLE SOON (On external system): RAM Expansion module.
Combined EPROM eraser/programmer module.
Further ROM expansion modules.

PRICE (Inclusive): External system £59.95 + £2 p&p
Internal system £47.95 + £1 p&p

PAYMENT: Send your remittance (cheques/PO only please)
with your order to:

MICRO-Z LTD.
P.O. Box 83, Exeter, Devon EX4 7AF
S.A.E. for full details.

The Original "NEWARK" TV/RGB Monitor

It's a 14" remote control Grundig TV!!
(Electron)

ORIC
ATMOS
(BBC/Acorn)
(MSX)

It's an RGB computer monitor
QL
(Almost)

It resolves 80 characters!!

It's £249.94 inc VAT - complete Package!!

The Package:

£249.94 for a remote control 14" TV with a computer lead - delivered to your door - including VAT

(We even fit a mains plug!) and carriage
We have a LARGE range of GRUNDIG models from 14" to 26" with or without Teletext.

Contact Elaine for an up to date leaflet package

NEWARK VIDEO CENTRE LTD

108 London Rd, Balderton, Newark, Notts.
Tel: 0636 71475 to order by Access or Visa. Mon-Sat/9am-6pm

STAR GAZER

an exciting, new and sophisticated Study Pack from Small School that provides a friendly introduction to astronomy for all ages.

A suite of matched study units teaches you to recognise and name the constellations and stars of the Northern Sky.

In the Sky View program just type in your latitude, date, time and direction of view and the VDU becomes a window to the stars. Use the cursor keys to explore the heavens from horizon to horizon. Press the D-key and the constellations will be picked out and named.

All programs are menu driven and a special, integrated, 5" disc version is available (state 40/80 track).

Star Gazer is supported by a comprehensive 20 page manual with user and background notes, star tables and a foldout map of the Northern Sky, packed in an attractive, plastic case for the library shelves.

Comments from field trials:

"An excellent well set out package..." **Cassette version £9.95**
"Most enjoyable..." **5 1/4" disc version £11.95 P&P inc.**

BBC &
Electron



SMALL SCHOOL SOFTWARE,
Mail Order Department (M),
14, Saltmarsh Lane,
HAYLING ISLAND,
Hampshire PO11 0JT.

an INTRODUCTION to

R A N D O M
A C C E S S
F I L I N G

on the
BBC MICRO

This 120 page book is supplied with a FREE floppy disc containing TWO demonstration systems - a STOCKFILE SYSTEM and a PERSONNEL SYSTEM

IF YOU WANT

- to use your disc drives as something more than just fast cassettes.
- to be able to store and retrieve data instantly.
- to learn how to create your own systems.
- to understand how Filing Systems can work.
- to join the vast numbers of people worldwide who have benefited from this package.

THEN YOU CAN BUY THE BOOK FOR £12.50 COMPLETE FROM:

**The Computer Room 206 Main Street
Newthorpe Nottingham 0773 718578**

Teletext listing

From Page 59

```

460 VDU 23,230,0,8,28,42,8,8,8
    ,0
470 VDU 23,231,0,0,0,127,0,0,0
    ,0
480 VDU 23,232,64,64,64,66,70,10
    ,30,2
490 VDU 23,233,20,20,20,20,20,20
    ,20,0
500 VDU 23,234,96,16,96,18,102
    ,10,30,2
510 VDU 23,235,0,8,0,127,0,8,0
    ,0
520 VDU 23,236,0,252,252,252,252
    ,252,252,0
530 PROCassem
540 ENDPROC
550
560 DEF PROCsetline
570 IF YX>setline+1 OR top=FALSE
    THEN top=TRUE
    :bottom=FALSE
    :setline=YX
580 IF YX=setline+1 AND top=
    TRUE
    THEN top=FALSE
    :bottom=TRUE
590 ENDPROC
600
610 DEF PROCgraph(cX)
620 LOCAL L1,L3,L4,L5,L6,L8,sX
630 IF cX=96
    THEN cX=35
    ELSE IF cX=95
    THEN cX=96
640 cX=(cXAND &7F)-32
650 IF cX>=64
    THEN L6=&F
    :cX=cX-64
660 IF cX>=16
    THEN L6=L6+&F0
    :cX=cX-16
670 L8=L6
680 IF cX>=8
    THEN L4=&F
    :cX=cX-8
690 IF cX>=4
    THEN L4=L4+&F0
    :cX=cX-4
700 L5=L4
710 IF cX>=2
    THEN L1=&F
    :cX=cX-2
720 IF cX=1
    THEN L1=L1+&F0
730 L3=L1
740 IF separate=TRUE
    THEN L3=0
    :L5=0
    :L8=0
    :L1=L1 AND &EE
    :L4=L4 AND &EE
    :L6=L6 AND &EE
750 VDU 23,226,L1,L1,L3,L4,L5,L6
    ,L6,L8
760 sX=&C10
770 PROCoutput(sX)
780 ENDPROC
790
800 DEF PROCdiff(cX)
810 cX=cXAND &7F
820 cX=cX-90
    :IF cX>5
    THEN cX=cX-27
    :IF cX>10
    THEN cX=10
830 sX=(&C10+cX*8)
840 PROCoutput(sX)
850 ENDPROC
860
870 DEF PROCprint(cX)
880 cX=cXAND &7F
890 sX=bX+(cX-32)*8
900 PROCoutput(sX)
910 ENDPROC
920
930 DEF PROCexpand(sX)
940 IF bottom=TRUE
    THEN sX=sX+4
950 FOR KX=0TO 3
    :KX?(mX+KX)=KX?sX
    :KX?(mX+1+KX)=KX?sX
    :NEXT
960 ENDPROC
970
980 DEF PROCoutput(sX)
990 IF double=TRUE
    THEN PROCexpand(sX)
    :sX=&C08
1000 !&80=sX
1010 !&82=pX
1020 CALL &C90
1030 FOR LX=0TO 7
    :VDU 1,LX?&C00
    :NEXT
1040 ENDPROC
1050
1060 DEF PROCassem
1070 codeX=&C90
1080 source=&80
1090 dest=&82
1100 loc=&84
1110 bit=&85
1120 put=&86
1130 off=&87
1140 table=&88
1150 FOR pass=0TO 2 STEP 2
1160 PX=codeX
1170 [OPT pass
1180 LDY#7
1190 LDA#0
1200 .clear STA (dest),Y
1210 DEY
1220 BPL clear
1230 LDX#8
1240 LDA#128
1250 .init STA table-1,X
1260 LSR A
1270 DEX
1280 BNE init
1290 LDA#&FF
1300 STA off
1310 LDA#7
1320 STA loc
1330 .outer
1340 LDA#7
1350 STA bit
1360 LDA#&FF
1370 STA put
1380 INC off
1390 .inner
1400 INC put
1410 LDY loc
1420 LDX bit
1430 LDA (source),Y
1440 AND table,X
1450 BEQ next
1460 LDX off
1470 LDA table,X
1480 LDY put
1490 OR A (dest),Y
1500 STA (dest),Y
1510 .next DEC bit
1520 LDA bit
1530 BPL inner
1540 DEC loc
1550 LDA loc
1560 BPL outer
1570 RTS
1580 J
1590 NEXT
1600 ENDPROC
1610
1620 DEF PROCload
1630 CLS
1640 INPUT ""Dump which file"
    ,file$
1650 $cmdX="LOAD "+file$+" 7C00"
1660 XZ=cmdX
    :YX=cmdXDIV 256
1670 CALL &FFF7
1680 ENDPROC

```

This listing is included in this month's cassette tape offer. See order form on Page 193.

MODULAR MICROCOMPUTER CONSOLES FOR SCHOOLS, HOMES AND OFFICES

Just 2 examples of our extensive range of consoles. This system is easily adapted to suit your personal requirement and can be readily expanded upon. The consoles support your TV/monitor safely above your micro and provide safe storage for disk drive/s, cassette recorder, books etc. The sturdy, well designed, mild steel construction also enables your micro to be stored safely underneath when not in use.



All consoles are formed with double bends to provide a completely safe edge to the front and rear whilst the bottom edge has rubber trim for safe use on desks etc. Attractive textured finish in either black or BBC colour match. Whilst these consoles are designed for the BBC micro they lend themselves perfectly to a variety of other models.



Write or phone for full colour brochure including dimensions and price list.

From £19.75 + VAT

TRADE, EDUCATIONAL ENQUIRIES WELCOME, DISCOUNTS AVAILABLE

J & W BUNCE

Thorpe Industrial Estate, Unit 3, Crabtree Road,
Thorpe, Egham, Surrey TW20 8RN.
Egham (0784) 33555

Soft Option

1/2 PRICE SOFTWARE

FOR BBC MICRO & ELECTRON
LATEST SOFTWARE
AT DISCOUNT PRICES
SELL BACK OPTION WITH 50% REFUND

e.g. Your first purchase might be a cassette at say £6.50, a saving on R.R.P. of £1.50. If within a month you wish to sell it back to us, we allow you £3.25 off your next purchase.

Write or phone for our stock lists:

SOFT OPTION

13 Edge Avenue, Grimsby,
South Humberside DN33 2DD.
Tel: (0472) 751444.

Selection of slightly used software always available at even greater savings. All programs are guaranteed originals.

Blank floppy discs at unbeatable prices.

IF

you don't want to use your **BBC MICRO-COMPUTER** for listing ADDRESSES, learning ALGEBRA, looking up your APPOINTMENTS, preparing simple BALANCE SHEETS, playing your own one-armed BANDIT, checking your BANK BALANCE, working-out the real costs of your CAR, creating your own DATA-BASES, just DOODLING, checking the date on your CALENDAR, CATALOGUING lists of whatever you like, looking-up and writing entries in your DIARY, playing GAMES, testing your GENERAL KNOWLEDGE, casting your own and friends' HOROSCOPES, enjoying colourful screen INTERLUDES, leaving MESSAGES for your family and friends, estimating MILEAGES between major cities, practising calculating amounts of MONEY, learning your MULTIPLICATION TABLES, playing NOUGHTS AND CROSSES, writing-out and looking-up your favourite RECIPES, seeing how your SAVINGS will grow, playing SNAP, doing SUMS, writing your personal TELEPHONE DIRECTORY, telling the TIME from an elegant Sun-clock, displaying your TIME-TABLE, testing your knowledge of WORD meanings, or writing your own XMAS card lists, all tailor-made for your own machine

AND

at the same time obtain a fully integrated 'SK-2000' program package system capable of accommodating all your own programs ('SK-2000' is the most versatile system of computer programming, organisation and management available for the **BBC MICRO-COMPUTER** backed-up by advisory, information and patch-in services)

THEN

don't send a cheque for only £50 to:

MILL SOFT
'HUMFORD MILL'
BEDLINGTON
NORTHUMBERLAND
NE22 5RT

for the most comprehensive suite of fully structured programs ever written for the **BBC-COMPUTER**

ELSE

buy over thirty odd programs instead for a total cost of around £500

REM

TAPE (please state Model 'A' or 'B') · DISC (please state format)

Logical SOFTWARE

HIGH QUALITY CASSETTE-BASED
SOFTWARE FOR THE BBC
MICROCOMPUTER (32K).

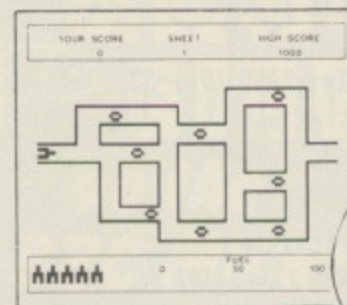

NIGHTMARE MATHS

Get through the space-maze solving maths problems on the way, but watch out for the comets, laserbolts and meteors. High score table and extra 'sheets' for the successful. Three levels of difficulty, with graded hazards too. Age 10 upwards.

PICTURE

Use this package to create new characters and combine them in high resolution pictures. Characters and pictures can be saved and used in your own programs. Sample character sets and pictures included.

THE ESTABLISHMENT AND SHIPWRECKED

A two program package of simple text adventures, featuring fantasy environments. An ideal stimulus for creating writing and art.

Available from:-
LOGICAL EDUCATIONAL SOFTWARE,
12, Rowditch Avenue,
Derby, DE3 3LD

(Please add 60 pence P + P to order total).

£7.50

£7.50

£7.50

Just what you've been waiting for!

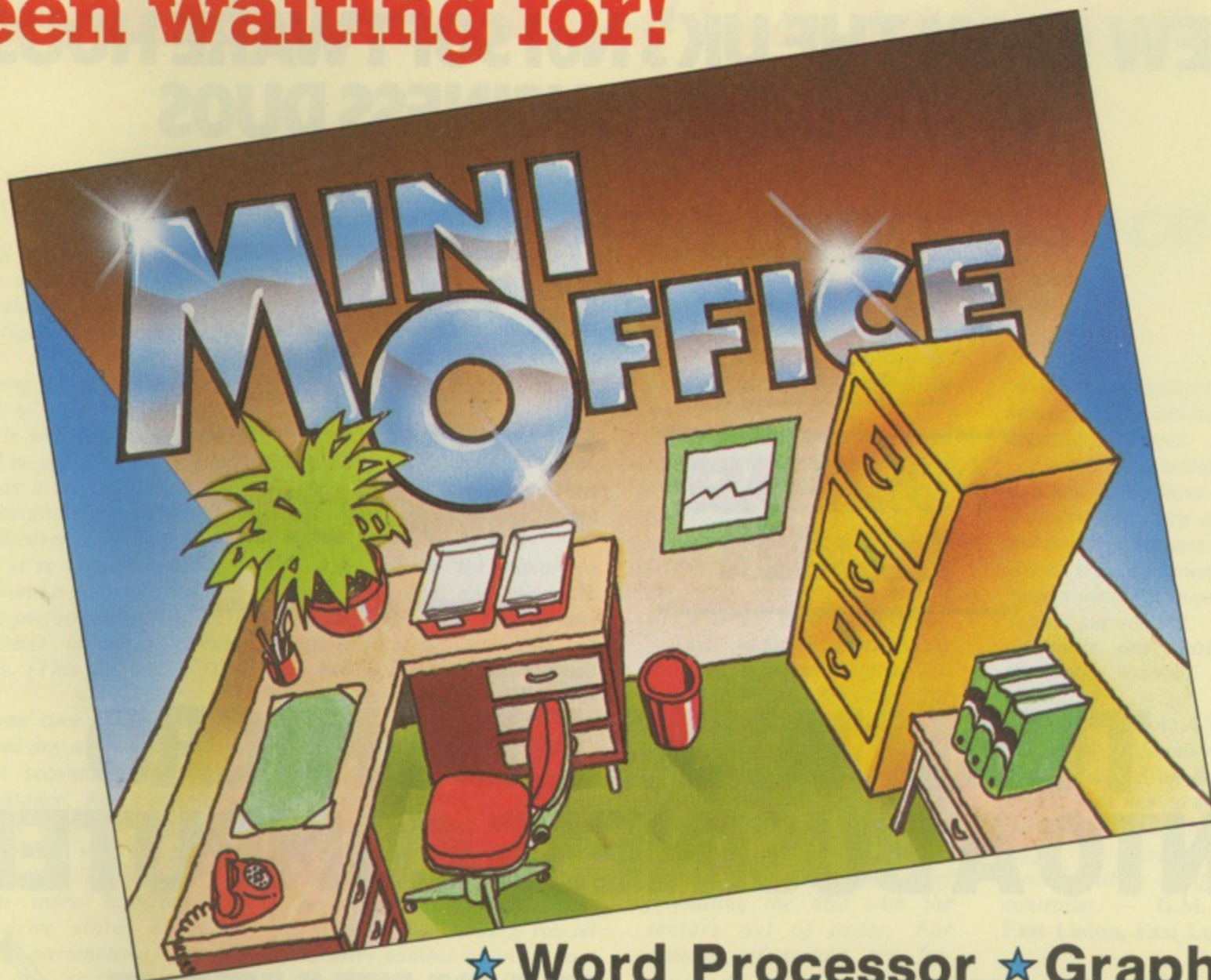

★ Word Processor ★ Graphics
★ Spreadsheet ★ Database

Now they're all together -in ONE simple package

Word Processor: Ideal for writing letters and reports. There is a constant display of both time and word count, plus a words-per-minute display to encourage the budding typist! A unique feature is the double-size text option in both edit and printer mode – perfect for young children and people with poor vision.

Spreadsheet: Enables you to use your micro for home accounts or pocket money records. It creates a display of numbers in rows and columns. Continuous updating is possible, and a changed figure can be instantly reflected throughout the rest of the spreadsheet. Your results can be saved, to be used for future updates,

or can be fed into its associated program...

Graphics: Part of the spreadsheet section, it lets you draw bar charts, pie charts and histograms to give a graphic presentation of your figures.

Database: You use this for storing information, just like an office filing cabinet. Facts you have entered can be quickly retrieved by just keying in a word or part of a word. They can be sorted, replaced, saved for future use or printed out.

If you want to start doing more with your micro than just playing games, this package is your ideal introduction to the four most popular applications for professional computers. All the programs have been designed for simplicity, so even a child can use them. Easy, fully-detailed instructions are included.

Please send me _____ copy/copies of
Mini Office

I enclose cheque made payable to Database Publications Ltd.
for £ _____

I wish to pay by
 Access Visa No. _____ Expiry date _____

Signed _____
Name _____
Address _____

<input type="checkbox"/> BBC 'B' cassette	£5.95
<input type="checkbox"/> Electron cassette	£5.95
<input type="checkbox"/> BBC 40-track disc	£7.95
<input type="checkbox"/> BBC 80-track disc	£7.95

Please tick box

Post to: Mini Office offer, Database Publications,
68 Chester Road, Hazel Grove, Stockport SK7 5NY.

Send for it today

NEW FROM THE UK'S No 1 SOFTWARE HOUSE SYSTEMATICS BUSINESS DUOS

**SALES
LEDGER**

**STOCK
CONTROL**

**PURCHASE
LEDGER**

INVOICING

TURN YOUR BBC MICRO INTO A BUSINESS COMPUTER

Especially for the BBC micro user, Systematics introduce a range of business software that transforms the BBC into a business management system.

The sales and purchase ledger takes care of cashflow problems. It controls ingoings and outgoing, keeping accounts up to date and issuing statements and reports at the appropriate time.

The stock control/invoicing duo monitors and automatically adjusts stock levels, whilst issuing purchasing recommendations. Furthermore this duo makes invoicing fast and efficient, producing instant invoices and credit notes.

Also available is the Info Master, a random access database with user definable print-outs for managing lists of all kinds.

Systematics experience in microcomputer software development is second to none. Now, with this experience, you can effectively tackle the space invaders before dinner and your bookkeeping after!

Systematics "Business Duos" are available in both cassette or diskette form to suit your BBC micro.

To order, use the coupon, or consult your local S.I. dealer.

RIGHT HERE

Systematics International Microsystems Ltd.
Cleves House, Hamlet Road, Haverhill, Suffolk.
CB9 8EE

Tel: (0440) 61121 Telex: 99431 SIG

Please send me the following Systematics Business Duos at £89 each. (Tick Box)

- Sales ledger/purchase ledger
 Stock control/invoicing

Please send me the Info Master at £49 (Tick Box)

- Info Master

Please add £1.50 p+p and insurance. Allow 28 days for delivery.

I enclose PO/Cheque payable to Systematics International

Number

NAME

ADDRESS

POSTCODE

Registered No. 1450171

Systematics

International



Systematics International Microsystems Limited, Cleves House, Hamlet Road, Haverhill, Suffolk, CB9 8EE. Tel: (0440) 61121. Telex: 99431 SIG.

I WAS
details
call to t
Miles G
issue.

Havi
mance
Basic i
should
this wa

Unfo
have di
mance
have fo
ing the
OSWC
stances
0.90).

If y
find th
half a
circum
read a
many
takes

Eve
read
(&67,
msec,
electre

As
multis
efficie
only a
sector

Cle
impos
400 r
code.
Af
DFS.
the d

THA
Flan
verte
June

I
worr
haye
prog
busi
to c
ong
with
whi
prog

MICROMAIL

Improved performance of &7F OSWORD

I WAS very interested to read details of the &7F OSWORD call to the DFS, in the article by Miles Gooby in your June 1984 issue.

Having found that the performance of disc transfers from Basic is well below that which should be possible, I hoped that this was a solution.

Unfortunately it wasn't, but I have discovered why the performance is so low. Even better, I have found a method of improving the performance of the &7F OSWORD in many circumstances. (This applies to DFS 0.90).

If you time &7F calls, you find that any action takes about half a second, regardless of circumstance. For example, to read one sector (averaged over many tries, without seeking) takes 460 milliseconds.

Even more ludicrous, the read drive status command (&67, no parameters) takes 400 msec, and this is a purely electronic operation!

As stated in the article, multisector operations are more efficient, and the time increases only a little for each additional sector.

Clearly each DFS call is imposing an overhead of about 400 msec, and that is a lot of code.

After digging about in the DFS, I found that on each call the drive and head are selected,

and the DFS loops until the drive becomes ready.

Now "ready" depends on a circuit (ICs 83, 84, 85) which sets a delay of .25 sec and then waits until the index hole passes by.

This allows the motor to come to speed, and the drive remains ready so long as the disc is rotating.

Fine if the drive was stopped when you called the DFS. But this circuit, and the delay loop, is triggered for every DFS call, even if the disc is still running on from the previous transfer.

The correct logic would be not to do the select if the drive number were unchanged and the drive was still ready.

Now the good news. If you set the drive number in an fcb to a negative value (that is 128 to 255), then all this code is bypassed and the previously selected drive is used.

Thus the drive number need only be set if it is the first access to the drive or after any action which might access another drive or the drive might have stopped.

Actually the last case is easy to deal with, because you get the error &10, "Drive Not Ready", - so retry with the drive number

set. The gains can be well worth while.

If you alter the verify code to set the drive only on the first transfer, it runs three times faster.

I was interested in searching files for the presence of character strings (with only a single sector buffer available).

This reduced immediately from 460 msec per sector to 220 msec average. However for specific applications like this it was worth formatting the disc with an interleave factor. Then the time reduced to 62 msec per sector, more than seven times faster.

Interleaving is a method of formatting the disc with the sectors out of order. For example, if sectors are formatted in the order 0741852963 instead of 0123456789, there are 2 sectors interleaved between every successive pair.

The idea is that your program can read a sector, do some work on it, and come back for the next one just as it is approaching the head.

The 8271 is quite happy to find the sectors out of order. The interleave factor must be tuned to the application.

Multisector operations, and hence LOADs and SAVEs, will actually be slower.

I would be interested to hear if other DFSs have cured the problem, and more especially if Acorn have changed later DFS issues. Would you want a CP/M system which took nearly half a second per sector?

Finally, one small point in the toolkit routines. Line 2150 should be:

```
2150 ROR A: AND# 1
```

The head number is 1 for drives 2 and 3 on double-sided drives. This has no effect on the BBC Micro itself, but the discs might be unreadable on a machine using a different disc controller. - G.M. Dougan, East Linton, East Lothian.

Down the Tube?

WHILE generally agreeing with Alan Plume's enthusiastic review of the 6502 second processor and the Bitstik I feel he has underplayed the drawbacks and annoyances of the systems.

Potential users must be prepared to find the great majority of popular firmware, such as Wordwise, not working when the second processor is powered up.

Turning the mains on and off is inelegant. Why didn't Acorn create an FX call to enable/disable the processor?

While obviously many software houses will blame Acorn, most of the problems appear to be caused by non-conformance to Acorn's published rules.

No doubt software houses will be able to have a second bite at the cherry by selling second processor compatible

Something good from Nuneaton

THANK you for printing Mr Flanagan's letter on getting inverted commas to PRINT in the June 1984 of The Micro User.

I have for some time been worrying my head over this, as I have written an analysis program for my husband's business and wanted to be able to call up a particular file of ongoing information, from within the program, for whichever consultant the program was being run.

Now, having obtained the consultant's name at the beginning of the program (A\$), the insertion of the lines shown right has resolved my dilemma.

I hope you approve of this letter written on a BBC B with Wordwise and an Olympia electronic compact typewriter - a system I have found most satisfactory. - Ruth Samways, Plymouth.

P.S. I always knew something good would come out of

```
90 IF A$ = "KEITH SAMWAY  
S" THEN D$ = ""DATAS""  
100 IF A$ = "FRED BLOGGS"  
THEN D$ = ""DATAB""  
110 IF A$ = "MARY JONES"  
THEN D$ = ""DATAJ""  
200 D=OPENUP D$  
210 PRINT#D,W,WW:REM etc  
etc etc  
220 CLOSE#D
```

Nuneaton, whatever Terry Wogan says!

MICROMAIL

From Page 177

upgrades of existing products. As regards I/O, the Bitstik lacks an input digitiser but more importantly the highest resolution hardcopy output from the system is limited to a Mode 1 screen dump.

Thus the fine detail of drawings cannot be realised in spite of the infinite resolution claimed for the system. The original Apple Bitstik had a plotter driver, so why not the Acorn one?

On the plus side, the new Acorn DFS is a great improvement on the old one and does not hang up while printing/reading/editing long files.

View, although slightly unstable in scrolling at times, is superb in the system.

BCPL recognises the spare memory and a "high" version isn't necessary. To my surprise Watford's 1.3 DFS appears to work in the system, although my tests have not been very extensive.

Bitstik's precision drafting capability is a joy to work with and circuit diagrams are a doddle once a symbol library has been created.

Users just requiring extra memory for word(wise) processing should also seriously consider the alternative packages of Aries-B20 RAM expansion with Wordwise-B20 or the more expensive and versatile Solidisk system. — M.J. Maytum, Bedford.

Microweb standard

CAN I enter a plea on behalf of all users of Acorn's Prestel adaptor for Microweb to switch from the communications standard it currently uses to that of Prestel, V23 Mode2.

I have tried to contact Microweb with the Prestel adaptor without any success at all. I note from your recent issues that you have been advocating the multi-mode Nightingale modem.

If you were to make the

suggested change, then all users of the standard Acorn equipment would be able to talk to Microweb plus all the other Grapevine users, since they would be able to switch their modems to V23 with no problems.

I received my Prestel adaptor only last week, after having had it on order for many months. Since advance literature was not available I had to take pot luck that the unit would allow access to non-Prestel systems.

It does not (apart from BT Gold), and so may I warn prospective purchasers of this unit that if they want anything besides Prestel, then they will need a multi-mode unit, like the Nightingale.

Another useful piece of information prospective purchasers might like to have is that, contrary to preliminary information in the BBC Micro User Guide to the effect that the Prestel unit would use the 1MHz bus, it does not. It uses the RS423 socket, which will be a pest for anyone using a serial printer.

That said, I have no doubt that the Acorn unit is very good for its main stated purpose, to link to Prestel. I hope to verify this when my user i.d. and password are sent to me.

Meanwhile could Micro User please consider the above suggestion? I suspect many people will buy the Acorn unit, partly for the name, and also because it is cheaper than multi-mode units, hence with V23 Microweb will not cast the non-Nightingale users into outer

darkness, as it does at present. — R.D. Wright, Guildford, Surrey.

● Microweb is very much an interactive communications medium — we want people to talk to us as much as we want them to hear what we've got to say.

In order to do this we listen and talk at the same speed — 300 baud. We can't go faster for technical reasons.

However Prestel doesn't expect much user response and can share out the speeds differently, using 1200 baud when it talks, and only 75 when it listens.

Both systems have their advantages. While at the moment Microweb is staying at 300 baud, we are strongly considering adding facilities for Prestel type modems. In fact, all we want to be sure of is the demand, so if you want a 1200/75 baud Microweb, write in and tell us.

We would still recommend a modem with multiple baud rates. Considering their extra power, they cost very little more.

Eprom copying

IN a recent advertisement Solidisk claim to have sold 10,000 units. Even assuming this to be a slight exaggeration, there are quite a few Solidisks around and now with the 256k upgrade on offer this will no doubt encourage further sales.

The system lends itself to eprom copying. We all know there is no such thing as com-

plete software protection. However there is a trade off to be made — the effort expended to break the protection, or find someone with the eprom you need, the gratuity paid to let you copy it, photocopying the manual. All this against the cost of the legal purchase.

While a few folk will delight in the challenge of breaking the protection, most just want the software and are willing to pay. But who wants to purchase an eprom to offload it at once?

Software suppliers do nothing to cater for this market, they just complain about piracy.

Why not offer Solidisk owners the eprom programs on tape? The cost should reflect the saving of eproms and create another outlet.

The majority of micro users do not begrudge the programmer his pound of flesh, but they don't want to part with the whole sheep. Will any software house give a lead? — R.D. Esson, Wembley, Middlesex.

● Interesting point. So far we've only heard of one company offering their products at a lower price for Solidisk users. Perhaps it will catch on.

Need for a DFS ROM

IF a disc interface is fitted, is there any need for a DFS ROM? If so, what does the ROM do?

This leads to a second point. Where exactly, is the ROM

No Olympic joysticks

wear on the keys, and that would be an option to use joysticks.

I would be very grateful if it would be possible to produce a joystick version which I would be able to exchange for my present one. — Tom Lewis, St Erth, Cornwall.

● Whereas all keyboards are standard, all joysticks are not — we only wish they were. It would be impossible to write a

program to cater for all the variations and sensitivity in all available joysticks.

Apart from this fact, backward and forward movement of the joystick lever at the rate needed would cripple it, and the buttons on a double fire button stick are not sensitive enough.

Sorry, your fingers are just going to have to get stronger and stronger.

● Want to write to Micromail? The address is: Micromail, The Micro User, Europa House, 68 Chester Road, Hazel Grove, Stockport SK7 5NY.

socket? I am puzzled by this as the User Guide says the ROM socket is on the left hand side of the keyboard.

In *The Micro User* I have read articles and adverts about internal ROMs. This contradicts what is said in the User Guide. I thought ROMs are large cartridges that plug into the socket mentioned in the User Guide. — Kevin Lomax, Bolton, Lancs.

● Second point first. There are lots of ROMs on the BBC Micro.

The ROM socket mentioned on the left hand side of the keyboard is supposed to go in place of the perforated plastic rectangle there.

The socket is meant by Acorn to take ROMs containing additional vocabulary for your speech synthesis chip, or alternatively cartridge type programs on ROM. Other firms are now using the "ashtray" to fit a ROM extension socket, allowing you to change ROMs without removing the micro's lid.

Then there are the amazing sideways ROMs hidden away under the keyboard. You have to dismantle the micro to get at these. They are Acorn's master touch, giving the BBC Micro incredible power by allowing you instantly to turn the micro into a word processor, communications terminal, machine code development system and so on and so on. Not only that, the chips can share jobs out with each other!

Now one of these ROMs is the DFS chip, which like the other chips, is a clever kind of program. This allows the BBC Micro to make use of discs. However it needs quite a few other chips and sockets to do this. The whole ensemble is called the disc interface.

Better pilot now

I ENJOYED the game *Space Pilot* in the June 1983 *Micro User*, but was disappointed to discover that the program *Joykeys* (October 1983) did not

work as negative Inkeys are used to detect key closure, so I did it myself.

Change line numbers 120, 160, 170, 180, 190, 890 and 900 to the following:

```
120PROC:IF (ADVAL(0) AND
3) =1 AND LX>8 PROC6
160DEFPROC(RQZ):IF ADVAL
(2)DIV256<80 YZ=YZ-RQZ*(20/
WZ)
170IF ADVAL(2) DIV256>180
YZ=YZ+RQZ*(20/WZ)
180IF ADVAL(1) DIV256<80X
Z=XZ+RQZ*(30/WZ)
190IF ADVAL(1) DIV256>180
XZ=XZ-RQZ*(30/WZ)
890IF ADVAL(1) DIV256<80D
RX=DRX+2 ELSEIF ADVAL(1) DI
V256>160 DRX=DRX-2
900IF (ADVAL(0)AND3)=1 DR
1Z=DR1Z+2:MOVEXZ,YZ:VDU226:
PROCF0:6COL4,0:SOONDO,-5,4,
1:MOVEXZ,YZ:VDU226:IF F<8 E
NDPROC
```

It's a good game now! — Richard Deakin, 51 Kalmia Way, Forrestfield, Western Australia.

Bye-ter bitten

I DON'T know whether Mr Bye (*Micromail*, May 1984) will be relieved or disappointed to find that I am not a schoolmaster and have no wish to give him "six of the best" for his views. (I would reserve punishment for the editors, and contributors, who publish programs which cannot possibly work!)

If we are to follow the school analogy though, I would give him a B—for not thinking things through properly.

He is absolutely right in thinking that merely replacing GOSUB with PROC will not produce a properly structured program. The program on Page 63 of the May issue, which has obviously been converted from another version of Basic with

only the changing of GOSUBs, provides an excellent counter-example.

You can still see the gap in the main program to allow the GOSUBs to have the early line numbers.

The real problem is that the division into modules, whether procedures or functions, comes at the design stage, not when we are writing the actual Basic statements.

If the design has been done properly the procedures will fall out naturally, without any need to put them in specially.

It is, in fact, a much more natural way of thinking about a problem. If we are telling someone else we say "If this is true then do that" not GOTO.

Perhaps one of the biggest problems for hobby programmers is that most of us do not design programs at all; we get our pleasure from writing the Basic code.

This lack of design often leads to over-complicated programs which are difficult to amend or debug. If programs are properly structured amendments are relatively easy, and confined to well-defined parts of the program.

Printing mailing labels is, for instance, a self-contained task and, if the job is contained in PROCprintlabels, it is not difficult to change the program if the size of label changes.

If we mix the printing in with the selection of labels to be printed we will probably need more changes and the whole of the program will need retesting.

If we use functions and procedures with the minimum of contact with the rest of the program, by using parameters and local variables, we can gain a further advantage.

We can, in effect, extend Basic by storing standard tested code for use in many programs with no change except for renumbering.

I now have a collection of standard modules for such things as validated input, reading the real time clock and drawing circles.

When I bought the graphics

ROM I was able to amend my circle procedure and know that the program remained correct.

I cannot think of any time when a GOSUB gives an advantage over a procedure, and repeated use of procedures is quicker than GOSUBs, for which Basic has to search every time they are used.

GOTO and GOSUB are provided in the language but their proper use is, surely, to allow us to convert programs not designed by ourselves from other computers. — David H. Wild, Hemel Hempstead.

Sydney user group

WE would be grateful if you would inform your readers that a new user group is to be set up in Sydney, Australia, and advise any interested persons to make contact at the Sydney BBC Microcomputer User Group, c/o Mr Stuart McCann, 500 Miller Street, Cammeray, N.S.W. 2062, Australia. Tel: Sydney 923 1137. — R. Stuart-Harris, Killara, NSW.

Speedier micro

I HAVE discovered a method of speeding up the already fast Beeb. Type:

```
?&FE45=255
```

and:

```
?&FE46=255
```

This accesses the timers for the system VIA causing the computer to virtually ignore the keyboard and concentrate on executing the program.

This increases the time for a FORI%=1 TO 10000 loop from 7.5 seconds to 0.3 seconds.

This is ideal for a program where a large amount of processing is involved but if any input is required it will need to be reset to a more normal value.

Type:

```
?&FE45=14
```

```
?&FE46=12
```

These values may vary

MICROMAIL

```

10 REM Prime number gene
rator
20 REM (c) B.Daulton
30 MODE7
40 VDU23;B202;0;0;0;

50 PRINTTAB(10,5);CHR$14
1;CHR$130;"PRIME NUMBERS"
60 PRINTTAB(10,6);CHR$14
1;CHR$130;"PRIME NUMBERS"
70 PRINTTAB(3,10);CHR$13
1;"This program generates p
rime"
80 PRINTTAB(3,12);CHR$13
1;"numbers in the range 1 t
o 17160"
90 PRINTTAB(4,20)"Press
the space bar to continue"
100 Z$=GET$:IF Z$(">") " TH
EN 170
110CLS:PRINTTAB(5,5);CHR$
134;"You will be asked to s
pecify the"
120 PRINTTAB(3,7);CHR$134
"first and last numbers."
130 PRINTTAB(4,9);CHR$130
"To show all primes in the
specified"
140 PRINTTAB(3,11);CHR$13
0"range you should not spec
ify a range"
150 PRINTTAB(3,13);CHR$13
0"of more than 700"
160 PRINTTAB(5,20);"Press
the space bar to continue"
170 Z$=GET$:IF Z$(">") " TH
EN 170
180 DVID=&70;DVIS=&72;DVI
DCH=&73;DVISCH=&75
190 NUM=&76;FIRST=&77;LAS
T=&79;Count=&78;OSWRCH=&FFE
E
200 FOR PASS = 0 TO 2 STE
P 2:P%=&900
210 [OPT PASS
220 .BEGIN
230 LDY DVISCH
240 LDA FIRST:CMP #1:BNE
Continue
250 LDA #3:STA DVIDCH:LDA
#2:STA FIRST:JMP Next
260 .Continue
270 CMP #2:BEQ Next
280 CMP #3:BNE PDIV
290 .Next
300 LDX #7:LDA #9
310 .Space
320 JSR OSWRCH:DEX:BNE Sp
ace
330 LDA FIRST:ADC #48:JSR
OSWRCH
340 CMP #50:BNE PDIV
350 INC FIRST:JMP Next
360 .PDIV
370 LDA NUM:STA DVIS:LDA
DVIDCH:STA DVID:LDA DVIDCH+
1:STA DVID+1
380 LDX #16:LDA #0
390 .LOOP
400 ASL DVID:ROL DVID+1:R
OL A
410 CMP DVIS:BCC OVER
420 SBC DVIS
430 .OVER
440 DEX:BNE LOOP
450 CMP #0:BEQ NEXNUM
460 INC NUM:INC NUM
470 LDA DVISCH:CMP NUM:BM
I PRIME
480 JMP PDIV
490 .NEXNUM
500 INC DVIDCH:INC DVIDCH
510 LDA #1:CMP DVIDCH:BNE
600N
520 INC DVIDCH+1
530 .600N
540 LDA DVIDCH:SEC:SBC LA
ST:LDA DVIDCH+1:SBC LAST+1:
BPL FINISH
550 DEY:BNE AFTER
560 INC DVISCH:LDY DVISCH
570 .AFTER
580 LDA #3:STA NUM:JMP PD
IV
590 .PRIME
600 LDA DVIDCH:STA DVID:L
DA DVIDCH+1:STA DVID+1
610 .CONVERT
620 LDX #16:LDA #0
630 .LOOP1
640 ASL DVID:ROL DVID+1:R
OL A
650 CMP #10:BCC LESS1
660 SBC #10:INC DVID
670 .LESS1
680 DEX:BNE LOOP1
690 CLC:ADC #48
700 PHA:INC Count
710 LDA DVID:ORA DVID+1:B
NE CONVERT
720 LDA #9:SBC Count:TAX
730 .SPACE
740 LDA #9:JSR OSWRCH
750 DEX:BNE SPACE
760 .DISPLAY
770 PLA:JSR OSWRCH
780 DEC Count:BNE DISPLAY
790 JMP NEXNUM
800 .FINISH
810 LDA #10:JSR OSWRCH:JS
R OSWRCH:JSR OSWRCH:JSR OSW
RCH
820 RTS
830 ]
840 NEXT PASS
850 MODE1
860 VDU23;B202;0;0;0;
870 COLOUR2:INPUT TAB(1,1
0)"Range required.(First,La
st)",a,B
880 IF a<1 OR a>17160 OR
B<a OR B>17160 THEN 850
890 IF a DIV 2= a/2 THEN
A= a+1 ELSE A=a
900 CLS: TIME=0
910 PRINT TAB(5,2)"PRIME
numbers between ";a;" & ";B
920 PRINT
930 !DVIDCH=A: ?DVISCH=IN
T(SQR(A))+1:?NUM=3:!FIRST=a
:!LAST= B
940 CALL BEGIN
950 PRINTTAB(8,28);"Time
taken = ";TIME/100;" secs"
960PRINTTAB(6,30);"PRESS
SPACE BAR TO CONTINUE"
970 Z$=GET$
980 IF Z$= " " GOT0850 EL
SE 980

```

From Page 179

slightly depending on what the computer is doing.

By inputting low values the computer will concentrate on the keyboard and output will be very slow. This enables you to see how the computer forms its characters.

Other strange effects may be seen. Play a Mode 2 game and in the middle of your game press Break. Type:

```
?&FE45=1
```

```
?&FE46=0
```

```
MODE 2
```

The screen that you were just playing will reappear and slowly clear. — I.A. Padgett, Tewksbury, Glos.

Last of the primes

FURTHER to my recent letter on the subject of generating prime numbers, I have now solved the problem of printing decimal numbers from the machine code program and enclose a copy of my finalised program (left).

Primes from 1 to 500 are produced in 0.57 seconds while the longest time taken over any sequence of 500 numbers (up to 17,000) is about 1.35 seconds.

The first and last numbers input may be odd or even. — B. Daulton, Lincoln.

● This correspondence is now at an end — please! Editor.

Problem cracked

REGARDING G. Black's letter in the June Micromail concerning keyboard costs . . .

I too suffered an intermittent keyboard fault. It was not the cost of repairs that daunted me, but the time it took — six weeks.

So armed with a soldering iron, an ohm meter and a magnifying glass I set forth. It soon became apparent that several

hairline
the prin
the keys.

These
and no s
have occ
Rainham

Good
valu

MR TA
1984, p
the hig
softwar
for bul
Whi
be boug
discs u
the or
covere
year g

hairline cracks were present on the printed circuit board under the keys.

These were easily bridged, and no similar further problems have occurred. — A. Moulder, Rainham, Essex.

Good value

MR TAYLOR (Micromail June 1984, page 182) complains of the high cost of disc based software. He quotes a price of £1 for bulk purchases of discs.

While I am sure that discs can be bought for such a sum, all the discs used by Dataware cost in the order of £3 each and are covered by a manufacturer's 5 year guarantee — this contrasts

with perhaps 40 pence for a tape.

Additionally our disc software utilises the superior facilities of the disc filing system and contains more data than the tape. We have never had a faulty disc returned — sufficient reason for not using cheap discs.

I trust that this puts things into perspective. — Les Peters, Dataware, Swindon.

Dicey..

I AM trying to program a game called cricket where instead of a ball only two dice are used.

On one die the data is "1", "2", "3", "4", "5", "6", "OWZAT" which is for the batsman. For the bowler the data is "Stumped", "Not out", "Bowled", "No ball", "Caught", "Lbw".

I know how to print random numbers but can you tell me how to print random words? — K. Howell, Northampton.

● We're not sure how you get seven things on one die. Casting our minds back, we reckon that '5' was missing on the first die.

Notwithstanding, if you know how to generate the random numbers required, simply use these numbers to index a subscripted variable. It sounds fancy, but Mike Bibby's beginners articles in the July and August 1984 issues make the ideas crystal clear.

In short, considering just the second die, make
die\$(1)="stumped"
die\$(2)="Not out" and so on. Then choose the one you mean to be die\$(RND(6)).

This will give you random words.

Memory fault

FIRST of all, add my name to your very long list (reached 'No room' yet?) of people who enjoy your magazine from the first to the last page.

When using the AUTO line numbering sometimes a white dot appears on the screen. When the line number 'lines' up with this dot (about 1-2 pixels) the numbering starts at 10 again. Any suggestions? (OS 1.20/DFS 0.90/BBC 100 drive).

In one of your articles it was claimed that *TV0,1 hardly made a difference. This is true for normal TVs, but it makes quite a difference on TVs converted into monitors.

The User Guide states that

If you want more from your MICRO

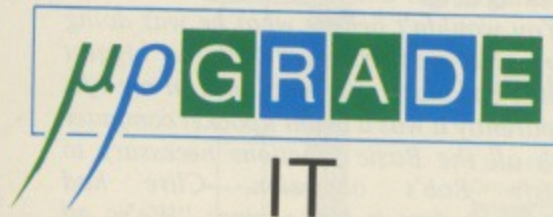

UPGRADE'ing your BBC micro (model "A" or "B") is the simplest, most cost effective way of dramatically improving its capabilities. An **UPGRADE** gives you access to the world's largest library of professional software and clears the way for future expansions by adding a Z80 A second processor 64K of additional RAM, and a flexible disk drive controller to your already powerful BBC micro. An **UPGRADE**'s ability to run TRUE CP/M rather than a CP/M compatible operating system is one of the features that make an **UPGRADE** the sensible choice. Couple this with its ability to handle disk drives independently from the BBC micro and your ability to choose what disk drives to use (3½", 5¼" or even 8") and you can see why an **UPGRADE** is the only choice.

Software available to run on your **UPGRADED** micro seems limitless. From wordprocessing to financial analysis for the professional user, to Pascal or Cobol for the serious programmer, all still capable of using the sound and graphics capabilities of the BBC micro. The choice does not end there though. An **UPGRADED** micro can be further expanded by adding up to three of our option boards to the unit. There are boards available for expanding the **UPGRADE**'s RAM, for providing further serial or parallel interfaces, additional disk interfaces for 5¼" or 8" disk drives. There is even a Winchester disk controller and an IEEE 488 interface option.

So if you **do** want more from your micro — **UPGRADE** it.

SPECIFICATIONS

Processor — Z80 A running at 4MHz
Memory — 64K RAM (fully expandable)
Operating system — CP/M (Supplied on disk)
Other operating systems available — TURBO DOS
Disk drives supported — 3½", 5¼", 40 or 80 track double or single sided, single or double density. Can be shared with the BBC micro.

NOTE: An **UPGRADE** does not require the fitting of a DFS within the BBC micro.

Disk drive capacities will vary dependent on disk drives fitted (example 5¼" DD/DS gives 800K storage).

Keyboard — As BBC

Graphics — As BBC

Power requirements — 240V AC.

PRICE: £299 + VAT

UPGRADE TECHNOLOGY, 290A High Road, London NW10 2EU.
Telephone 01-451 4416. Telex 46523. Symsys G.

**DEALER ENQUIRIES
INVITED**

MICROMAIL

From Page 181

END is optional, so why do I get 'No Proc' in:

```
10 N=0 : ENVELOPE 1,1,0,
0,0,0,0,0,10,-1,0,-1,126,1
20 REPEAT: N=N+2 : PROCS
OUND(N) : UNTIL N>80
30 REM .....END
40 DEFPROC SOUND(N)
50 SOUND 0,1,6,5 : TX= 1
NKEY(60-N)
60 ENDPROC
```

— K. Pigge, The Hague.

● Your problem with AUTO points to a definite memory fault

somewhere — or perhaps a ULA problem. Before taking it to a dealer though, why not take the lid off and press the chips down firmly. Often the only problem is the chips not seating properly.

END is optional only when you don't have to have it!

If you have procedures after the logical finish of the program and there's no END to stop it, the micro will just plough through into the first procedure (starting at line 40).

The important point to note is that it hasn't got there via a legitimate PROC call. When it encounters the ENDPROC at line 60, it hasn't come from a

PROC and so gives its plaintive 'No Proc' message.

Merging

MANY people have been confused over the issue of merging programs, over *SPOOL and the like.

There is a much more convenient method. If you want to merge the program in memory with one currently on tape, enter: PRINT ~ (TOP-2)

We'll call the answer NNNN.

Then:
*LOAD"PROG" NNNN
to load the second program,
PROG.

When the program/s have loaded, you should find that although you can see both programs, each will use their normal line numbers.

To remedy this, type RENUMBER — and the programs should have merged. — Richard Browning, Bishops Lydeard.

● Your method is, in fact, shown on page 402 of the User Guide, but let's face it, that's a long way to plough through for it!

On disc we reckon the *SPOOL method to be far the best, but for tape the method you describe is easier.

And finally, with tongue firmly in cheek . . .

Looking for MacRo User!

Dear Deidre,

Sorry I haven't been in contact yet, but Bob's been driving me mad. I thought that bringing him away on holiday to Scotland would cure him of the obsession with his thing but, alas, no such luck.

It started before we'd even left. I'd forbidden him to bring his micro or any computer books — and especially THAT magazine, the one with that unpleasant Barry Tree. It was only when I accidentally overheard a phone call Bob was making that I realised what was wrong. I was so shocked that I dropped the glass.

He was calling that awful Mike Cook (you know, the one with the artistic way with diagrams) and trying to find out a way of interfacing his Beeb with the car's cigarette lighter. I soon put a stop to that.

The drive up wasn't all that easy. Bob just sat there in the passenger seat watching the odometer with glazed eyes. Every now and then he muttered "so that's how binary works" and gave a deep sigh.

As soon as we reached Fort William he was out of the car and into every newsagent's hunting for the latest issue of Micro User.

I've never been so embarrassed in my life. Apparently his nephew Nigel had told him that there was a special Scottish edition of Micro User called MacRo User so he was asking for that.

Eventually I got him to the chalet. It was beautiful, miles from anywhere (including, sadly, the loo). Now I know what they mean by communing with nature.

Anyway, the first few days were

marvellous. He went all over the place. Skye, Aviemore, Sauckiehall Street, we saw Scotland in all its scenic beauty. Only one thing worried me, Bob wasn't whining as much as I would have expected. And he was spending longer and longer in the bathroom.

You wouldn't believe what he was doing there. He was playing with the biggest pocket calculator I've ever seen in my life. Apparently it was a Blunt's pocket computer with all the Basic functions necessary to satisfy Bob's obsession. Clive had apparently lent it him saying: "We're all men of the world, use this if it's absolutely necessary".

Of course I confiscated it immediately and soon Bob was back to his usual whining self.

I thought that maybe searching for the Loch Ness monster might keep him occupied but I should have known better. After an hour he started grinning to himself and I knew something was wrong. "I've got a great idea for a computer game", he blurted out before he could stop himself, "I'm going to call it Nessy Hunt".

With that I bundled him into the car and took him up Ben Nevis. I've found that if I tire him out it gets rid of his funny ideas.

It was at the tourist information centre in Fort William that, through the throngs of tartan-trousered American tourists, I saw the notice advertising a guided nature walk in Glen Nevis. Just the thing to keep Bob occupied, I thought, so there we were at 10 o'clock in the car park at the bottom of Ben Nevis waiting for the ranger.

I'd expected a Scotsman called Angus or

Jock in a kilt or something, but the ranger who turned up was wearing jodphurs, had a Birmingham accent and was called Walter.

Well the journey up the valley was fascinating. Walter really knew a few things about wild flowers. Fragrant orchids, butterworts, mountain saxifrage — he showed us them all.

Of course it was too good to last. As we were coming back down we passed through a quiet, lifeless wood.

"Like Mirkwood", Walter murmured. "Oh are you a Tolkien fan?" I asked. "Not really", he answered, "I just play the Hobbit on my Beeb".

Well it was like a starry saxifrage to a deprived botanist. Bob was in like a shot.

"Have you had trouble with Thorin? Alice did".

And that was the end of the nature walk. The rest of the trail was ignored as Bob and Walter rambled on and on about the Beeb, adventures and micros in general.

And that's how the holiday has turned out. Bob now spends all his evenings in the Tartan Haggis with Walter, knocking back heavy and discussing a map-reading program and a bagpipe tutor for the Beeb.

So once more I'm a micro widow left wondering what's so funny about a "loched file".

Next year it's Blackpool. See you soon,
Andrea

P.S. You'll never believe it, but Bob and Walter have actually sold a program. It's a follow-up to Micro Olympics, called the MacRo User Highland Games.

THE PRINTED WORD

LOW PRICES TOP SERVICE

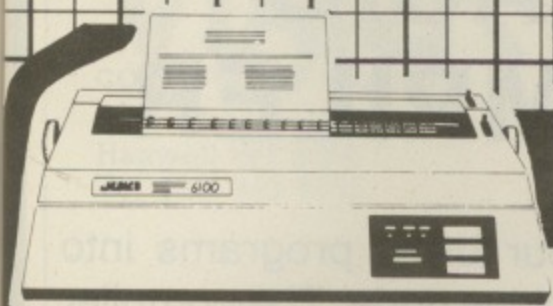

JUKI 6100

One Year Warranty
 20 CPS : BiDirectional & Logic Seeking
 10, 12, 15 & Proportional Spacing
 Wordstar Compatible
 2K Buffer : 13 Inch Platen
 Underline : Backspace + Lots more
 Centronics Interface Standard
 RS 232 Interface £54.00 + VAT Extra
 Tractor Feed £99.00 + VAT Extra
 Single Sheet Feeder £238.00 + VAT Extra

JUKI 6100 £347.83 + VAT = £400.00

**BBC/ORIC or DRAGON Package
 JUKI 6100 + CJE PRINTER PACKAGE
 £420.00 Inc. VAT**



CANON PW-1080A

Near letter Quality Printer

NLQ Mode 23 x 18 Matrix: 27 cps
 Draft Mode 11 x 9 Matrix : 160 cps
 Full range of Epson FX 80 Print Codes
 Friction & Tractor Feed
 Centronics Interface Standard
 CANON PW-1156A (Accepts 15" Paper) Available

CANON PW-1080A £295.65 + VAT = £340.00
CANON PW-1156A £391.30 + VAT = £450.00

**PACKAGE PRICE for BBC MICRO/DRAGON/ORIC
 CANON PW-1080A C.J.E. PRINTER PACKAGE £365.00 Inc. VAT
 CANON PW-1156A C.J.E. PRINTER PACKAGE £470.00 Inc. VAT**

Special RS 232 Printer Bargain

STAR DP8480 (8" Printing) £197.00 Inc. VAT
 Ideal for BBC/Newbrain/HX20 & Spectrum Int. 1
 Phone for full specification

C.J.E. Micro's BBC Printer Packs

For Star, Canon & Juki Printers include:

1. The Printer
2. Delivery by Securicor
3. Cable to the BBC 1.3 Metres
4. Screen Dump Program (M/C Source)
5. Text Dump Program
6. Function Key set up Program. For use with WORDWISE
7. Function Key Label Printing Program. For use with above.
8. VIEW Printer Driver
9. 100 Sheets of Paper
10. Mains Plug with 3 Amp Fuse
11. Booklet giving details of using the printer with a BBC.
12. Character Defining Program for Downloadable-character-set
 C.J.E. Printer Packs for other micro's include:-
 Printer, Cable, Paper, Mains Plug & Delivery

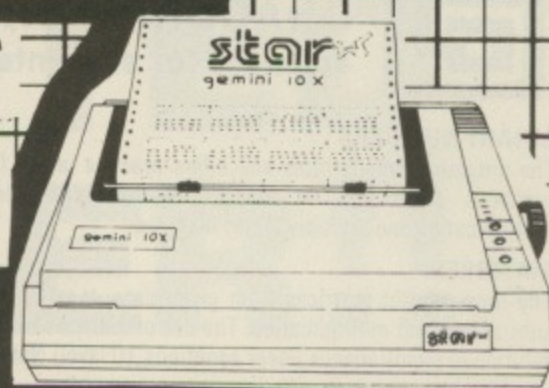

STAR GEMINI 10X

One Year Warranty
 True Descenders 9 x 9 Matrix
 120 CPS Bidirectional & Logic Seeking
 40, 48, 68, 80, 96, 136 cpl
 Italics, Emphasized, Double strike,
 Super & Sub Scripts
 Downloadable Character Set
 Hi-Resolution & Block Graphics
 Friction or Tractor Feed
 10 X 10" Carriage, 15 X 15" Carriage
 Centronics Interface Standard
 RS232 Int. £52.00 + VAT Extra

Gemini 10X £235.00 Inc VAT
 Package for BBC/DRAGON/ORIC
GEMINI 10X + CJE Printer Pack £255 Inc. VAT
 Star Gemini 15X £390 Inc. VAT

**STAR DELTA 10
 SPEC. AS FOR 10X PLUS:-
 160CPS: 8K BUFFER
 CENTRONICS + RS232 INT'S STD
 £320 + VAT = £368.00**

BBC MICROMODEL B £399.00 Electron £199.00

BBC Micro Model B with Disc Int. £469.00

Large Range of Accessories including Disc
 Drives, Printers, Monitors always in stock.

Printer Cables

BBC to 36 Way Centronics Type Connector £15.00
 Dragon to 36 Way Centronics Type Connector £15.00
 Oric to 36 Way Centronics Type Connector £15.00
 Torch to 36 Way Centronics Type Connector £20.00

Serial Printer Cables

BBC to 25 way D type £9.50
 EPSON HX20 to 25 way D type £9.50
 NEWBRAIN to 25 Way D Type £12.00
 25 way D type to 25 way D type £15.00

Blank C15/C30 Cassettes Ten for £4.50 ANY MIX
 Send SAE for Full Price List

VAT INCLUDED WHERE APPLICABLE PHONE/CREDIT CARD ORDERS WELCOME

Postage 50p per order or as stated
 24 Hr Securicor Delivery
 for Printers/Disk Drives £8.00
 (SHOP/WORKSHOP CLOSED MONDAYS)

C.J.E. Microcomputers

Dept (PCW), 78 Brighton Road, Worthing
 W. Sussex BN11 2EN (0903) 213900

EXPORT ORDERS WELCOME

**RING FOR SAMPLE PRINTOUT, FULL SPECIFICATIONS & LATEST PRICES
 BEST PRICES & BACKUP ON THE STAR JUKI & CANON PRINTERS**



CHADDINGTON
software for students

BINARY NUMBERS

The program demonstrates and offers practice in the formation of binary numbers, conversion to denary, together with addition, subtraction multiplication and division. Notes included. £10

MATRICES

The formation of matrices from given data, together with their addition, subtraction and multiplication. The use of matrices in transformations and solution of simultaneous linear equations. (O level) Notes included. £10

MULTIPLE CHOICE O LEVEL Mathematics (set 1)

A standard O level syllabus has been split into 10 sections, with 3 random tests of 10 questions on each section. A second disc contains a summary of the syllabus used. £12

MULTIPLE CHOICE O LEVEL mathematics (set 2)

A second set of 300 questions on the same syllabus sections as Set 1. £10

STATISTICS(1) - CHARTS

A set of programs including pie charts, simple bar charts, dual, sectional and monthly bar charts. (O level) Notes included. £10

STATISTICS(2) - FREQUENCY DIAGRAMS

The programs include the production of frequency graphs, histograms and cumulative frequency curves. (O level) Notes included. £10

A CLUSTER OF CURVES (A LEVEL interest)

A set of programs to draw 20 different curves, using polar coordinates, parameters and envelopes of lines and circles. Also sets of confocal conics. Notes included. £10

All notes are provided on strong A4 paper ready for filing. Postage and packing on 1 or more programs 75p

BBC 32K - 40 track discs (or cassette if required)

Electron - cassette

14 SELKIRK CLOSE,
WORTHING BN13 1PR

BASIC COMPILER

Turns your basic programs into really fast machine code. The compiler is very easy to use, and comes complete with full instructions.

For the BBC model B, or Model A with 32k.

Cassette	£17.95
Disk	£19.95
(40/80 TRACK)	

Cheque/P.O. or SAE for details to

ACK Data

21 Salcombe Drive, Redhill,
Nottingham, NG5 8JF
Tel. (0602) 262498

INTRODUCTORY PRICES FOR BEEB USERS NO EXTRA FOR UK VAT OR POSTAGE!

MENU DISC make all your discs menu driven. Sort out your files at last with this disc which enables files to be run at the touch of a single key. Simplicity itself to create/amend/delete the menu of your choice. Ideal when inexperienced operators or young children need to use the computer. may be copied for your own use with all your own discs.

MENU DISC (state 40 or 80 track) **£8.00**

USER PORT INTERFACE BOARD Interface and control or monitor external circuits for hobby, home security, process control etc. Invaluable as a software development aid since LEDs indicate the status of all 8 I/O lines and both control lines. DIL switches can simulate all inputs and invert all outputs. Separate terminal blocks for input and output logic connections and BEEB's own 5V supply. Optional relays can be fitted to each of the 8 output lines. **USER PORT INTERFACE BOARD £29.00**

INTERCONNECTING CABLE (to user port) £8.00
OPTIONAL RELAY (fitted) £2.00

KEYBOARD COVER Rigid moulded cover fits only over the keyboard and speaker sections, so may be used easily when the computer is installed with only the keyboard area accessible. Protects against dust and accidental damage.

KEYBOARD COVER £7.00

COMPUTER COVER Superior fitted black leatherette cover to protect your computer, available either plain or personalised with your own name or initials. **COMPUTER COVER (plain) £5.50**

PERSONALISING (per letter) 50p

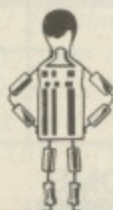

ELECTROLINK LTD

FREEPOST, Church Crookham
Aldershot Hants, GU13 0BR
Tel: 02514 4332 or 0252 543095
Order now, or ask for our free data sheet

Private Viewdata C-FAX

C-FAX is a package for setting up and displaying private TELETEXT information on a BBC Model B Computer (OS 1.2) Typical uses include advertising displays, electronic newspapers and notice boards, and specialised databases.

Up to 390 Teletext (Mode 7) pages can be stored on one disc and instantly recalled by the display program, which simulates the standard broadcast CEEFAX operation - including time/date and current page number display.

The software consists of the display program (on disc) and a ROM based editor which can be called up at any time to make changes or additions. In addition to the usual Mode 7 editor facilities, it is possible to copy or move any block of characters, insert or delete characters on a line, write in LARGE text, and use comprehensive Graphics routines.

C-FAX has the familiar features of broadcast Teletext and also supports Demonstration routines, Menu pages, Page chaining with variable display time, Animation, Musical tones, Programmed learning, and the counting of all pages requested.

The package includes a specially designed handset which connects to the BBC via the user port. A disc containing example pages is also supplied.

Package Price £99.00
Package without KEYPAD £45.00

(Please state 40 or 80 Track Disc)

The Keypad can also be supplied separately for £60.00 including software to redefine the keys to operate with your programs.

The above prices include VAT and P&P (UK)
Send Cheque/P.O. to:

MICROFAX LTD.

19 Grasmere Ave. Blackburn, Lancs. BB1 8LD

Viglen

COMPUTER SUPPLIES

Unit 7 Trumpers Way
Hanwell W7 2QA
Tel: (01) 843 9903

LIMITED OFFER!!

BBC MODEL B £369 INC VAT
WITH ACORN DFS £459 INC VAT

Plus £8 carriage. Offer whilst stocks last.



Ring **01-843 9903** NOW or fill in the coupon below.

Post to: VIGLEN COMPUTER SUPPLIES, UNIT 7, TRUMPERS WAY, HANWELL, LONDON W7 2QA.

MU9/7

Please send me ____ (qty) BBC Model B at £369 each + £8 carriage.

Please send me ____ (qty) BBC Model B with Acorn DFS at £459 each + £8 carriage. I enclose Cheque/P.O. for £ _____ made out to VIGLEN COMPUTER SUPPLIES or debit my ACCESS/BARCLAYCARD No. _____

Name _____   Signature _____

Address _____

TEC ● Viglen ● TEC ● Viglen ● TEC ● Viglen

TEC DRIVES

(As used by Cumana)

	Inc VAT	Excl VAT
Single sided 40 TRACK 100K 5 1/4"	£129.00	£112.17
Single sided 40/80 TRACK 200K switchable 5 1/4"	£169.00	£146.95
Double sided 40/80 TRACK 400K switchable 5 1/4"	£199.00	£173.04
For Dual TEC drives the price is double the single drive prices		
Integral Power Supply		
For single drive	£20.00	£17.39
For dual drive including dual case	£40.00	£34.78

Please add £8 for carriage

All disc drives complete with Professional Case – Ribbon Cable to connect to BBC Micro – Power cable to connect to BBC Micro – Comprehensive Manual – Formatting and utilities disc.

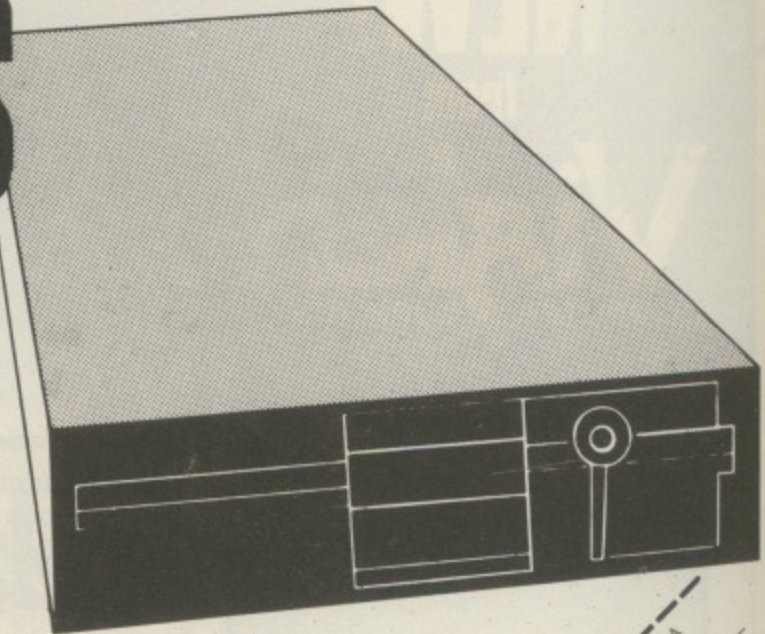

Viglen

COMPUTER SUPPLIES

Unit 7 Trumpers Way
Hanwell W7 2QA
Tel: (01) 843 9903

Post to: VIGLEN COMPUTER SUPPLIES UNIT 7, TRUMPERS WAY, HANWELL W7 2QA
Telephone: 01-843 9903 Personal Callers Welcome

Please send me _____

I enclose Cheque/P.O. for £ _____

I prefer to pay ACCESS/BARCLAYCARD (Delete whichever is applicable)

Card No _____

Signature _____

Name _____

Address _____

MU9/1

PHILIPS 14" COLOUR TV/MONITOR

£235 inc VAT

(TV only: £185 inc VAT)

As a company we chose the Philips because we believe it to have the clearest picture as well as being the best value.

Take our word for it, or come and see for yourself.

EASY ON-THE-SPOT PARKING. AND IT'S FREE!

Viglen

COMPUTER SUPPLIES

Personal Service & Quality coupled with Wholesale Prices, Unit 7 Trumpers Way, Hanwell, London W7 2QA.

Telephone: 01-843 9903.

For special attention to your orders or enquiries concerning MONITORS, PRINTERS, COMPUTERS, DISC DRIVES, ring 01-843 9903 NOW or fill in the coupon below.

TV/Monitor (resolution better than 585 x 450 pixels. Dot-to-dot distance .65mm)

Plus £8 carriage and packing





- Easy to carry • Lightweight • Sparkling picture in seconds • Reliability and performance excellent • Headphone Socket can also be connected to tape recorder • Loudspeaker mute switch • Retractable carrying handle
- Monitor/TV selected by switch • Includes RGB lead connecting direct to your BBC Micro. • Philips Model No. 14CT 2006/05T

Post to: VIGLEN COMPUTER SUPPLIES, UNIT 7, TRUMPERS WAY, HANWELL, LONDON W7 2QA.

MU9/2

Please send me _____ (qty) Philips TV/Monitor at £243 each. I enclose Cheque/P.O. for £ _____ made out to

VIGLEN COMPUTER SUPPLIES or debit my ACCESS/BARCLAYCARD No. _____

Name _____   Signature _____

Address _____

NEW!

from

Viglen

COMPUTER SUPPLIES

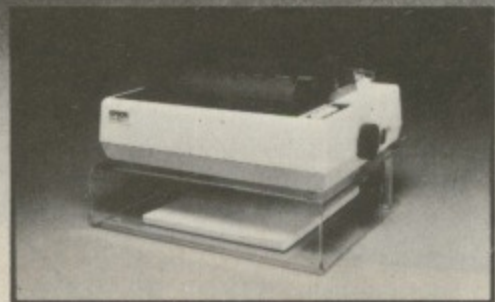

Printer Stand

£12.95 INC. VAT

Carriage & Packing £3.00

A PRINTER STAND

- For dot matrix printers
- Raises printer high enough to put continuous stationery underneath
- Beautifully finished in clear perspex • Viglen quality every time
- Will accept paper up to 12½" wide • Non slip rubber pads

Dimensions: 15" (380mm) wide 12½" (320mm) deep 4" (90mm) high

COME TO VIGLEN FOR A FAST, FRIENDLY, PERSONAL SERVICE



DEALER ENQUIRIES WELCOME

Post to: VIGLEN COMPUTER SUPPLIES, UNIT 7, TRUMPERS WAY, HANWELL, LONDON W7 2QA.

ML 9/3

Please send me _____ (qty) PRINTER STANDS at £15.95 each. I enclose Cheque/P.O. for £ _____ made out to

VIGLEN COMPUTER SUPPLIES or debit my ACCESS/BARCLAYCARD No. _____

Name _____   Signature _____

Address _____

**The
only
ROM**

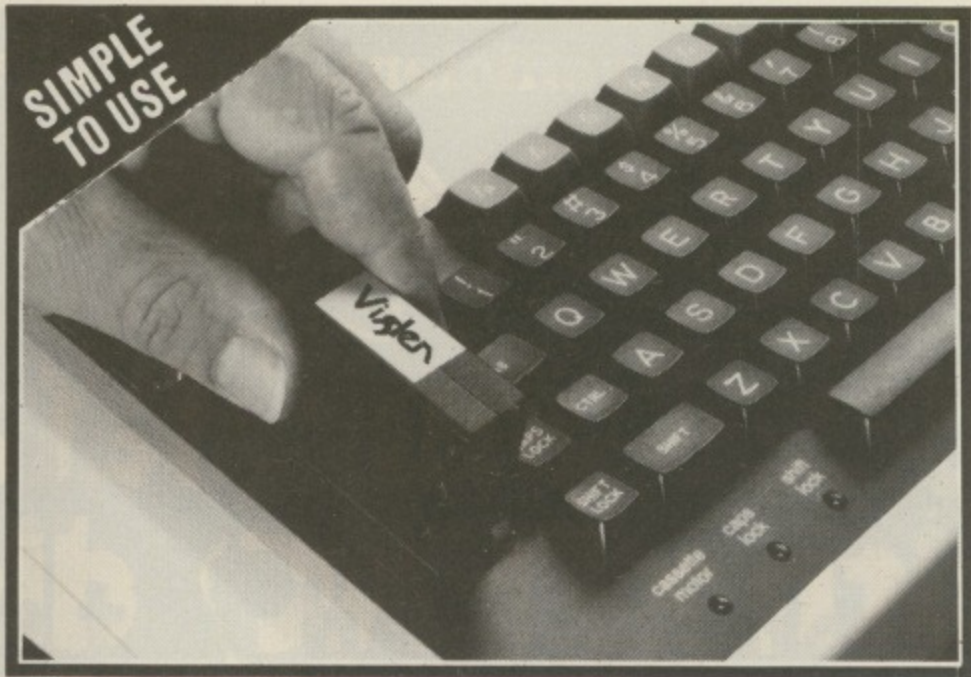

Cartridge System that does not overload your pocket or your BBC Micro

Why risk damage to your BBC micro every time you want to change ROM's? Instead, store your growing collection of ROM's in professionally-made protective cartridges!

- Insert and remove Wordwise, View, Disc Doctor etc. at will from your micro in absolute safety - no wear or damage to pins to your ROM's.
- Low, low power consumption unlike other systems.
- Saves on memory.
- Price for complete kit including one cartridge only **£19.95 inc. VAT.**
- Extra ROM cartridges £27.75 for five, £49.50 for ten cartridges and single cartridges £6.95 each.

Dealer enquiries welcome.

SEE US AT
The 2nd
Official
Acom User
Exhibition
OLYMPIA
16-19 AUGUST
1984

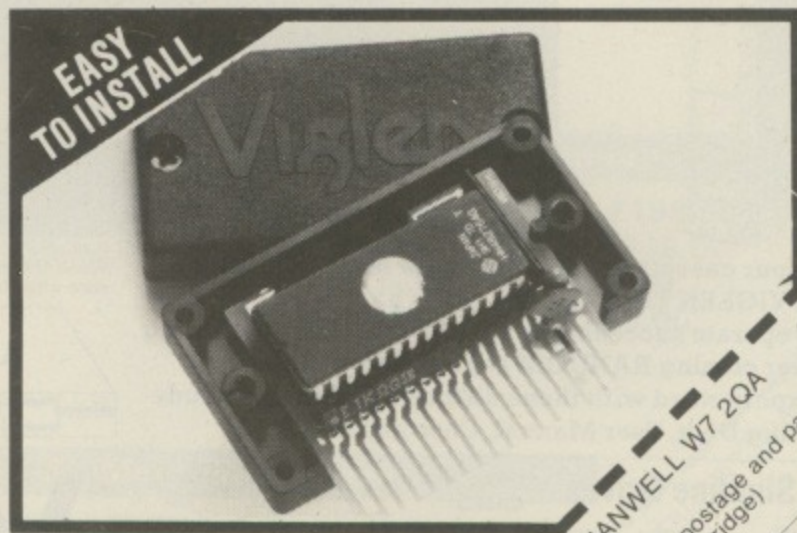

Viglen
COMPUTER SUPPLIES

Unit 7 Trumpers Way
Hanwell W7 2QA
Tel: (01) 843 9903

Post to: VIGLEN COMPUTER SUPPLIES UNIT 7, TRUMPERS WAY, HANWELL W7 2QA
Telephone: 01-843-9903. Personal Callers Welcome.
I enclose Cheque/P.O. for £
I prefer to pay ACCESS/BARCLAYCARD (Delete whichever is not applicable)
Kits
Please add £2.00 for postage and packing.
(50p only for single cartridge)

Card No.

Signature

Name

Address

Credit cards valid if signed by card holder. Address below must be the same as card holder.

Cheques payable to
Viglen Computer Supplies
MU9/4

Put an end to inefficient, slow cassette tape storage



Speed your data access with a TEAC disk drive from Viglen

Comprehensive, fact-filled, 53 page manual including techniques of loading from cassette to disc. Not available elsewhere



Replacing your cassette with a disk drive means data access in seconds! VIGLEN TEACS *unlike others* have been specially modified to operate successfully with ACORN and other filing systems, over coming RANDOM accessing problems normally experienced with these disk drives. Prices include VAT, Formatting Disk, User Manual, Case and Leads.

When ordering Dual Drives, please state which layout you prefer. A or B.

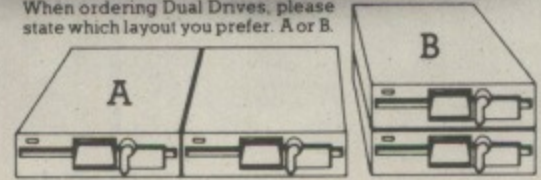

TEAC 55 Slimline Drives		Incl. VAT	Excl. VAT
SINGLE DRIVES CASED			
40 TRACK 100K	£143.75	£125.00	
40 TRACK 200K	£195.00	£169.56	
40/80 TRACK SWITCHABLE 200K	£179.00	£155.65	
40/80 TRACK SWITCHABLE 400K	£225.00	£195.65	
DUAL DRIVES CASED			
40 TRACK 200K	£287.50	£249.57	
40/80 TRACK SWITCHABLE 400K	£358.00	£311.30	
40/80 TRACK SWITCHABLE 800K	£450.00	£391.30	
DFS KIT—Acorn or C.U.C.	POA	POA	
Disc Filing System 100% Acorn Compatible			
Integral Power Supply	£30.00	£26.09	

All prices correct at time of going to press and all offers subject to availability.
 ● Utilities disk includes 13 useful utilities including: ● formatting ● verifying ● screen dump ● disassembler ● generating 62 files, etc.
 ● Orders welcomed from Educational Establishments and Government Departments.

Viglen

COMPUTER SUPPLIES

Unit 7 Trumplers Way
 Hanwell W7 2QA
 Tel: (01) 843 9903

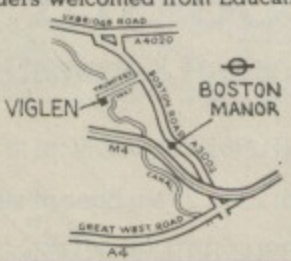

Full Twelve Months Guarantee

How to order
By post: To purchase any of the items simply fill in the coupon with your requirements. Enclose your Cheque/P.O. or use your Access/Barclaycard. Please make cheques payable to: VIGLEN COMPUTER SUPPLIES and post to above address. Allow seven days for delivery and add £8.00 carriage, package and insurance on all items.
By telephone: Ring (01) 843 9903. Credit Card holders (Access/Barclaycard only) can purchase by telephone. Please give Card No., Name, Address and the items required.

EASY-ON-THE-SPOT PARKING. AND IT'S FREE!

Post to: VIGLEN COMPUTER SUPPLIES UNIT 7, TRUMPERS WAY, HANWELL, W7 2QA

Please send me the following items:

I enclose Cheque/P.O. for £ _____

I prefer to pay by ACCESS/BARCLAYCARD* Card No. _____

Signature _____

Name _____

Address _____

PSA

VIGLEN

branches out

to offer the best value in monitors & printers

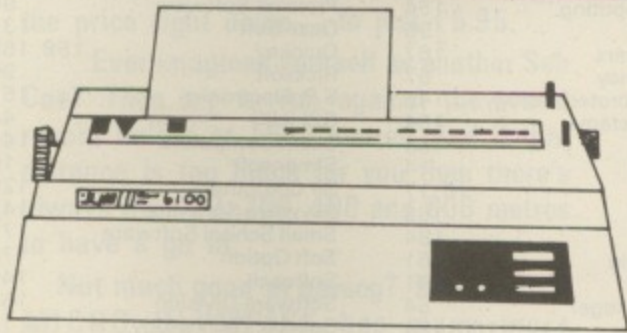

**NEW
SPECIAL
OFFERS**

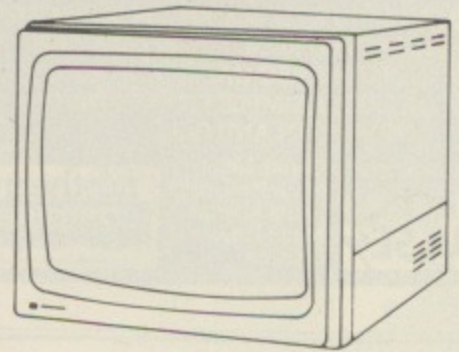

Dot Matrix Printers

- Epson RX80/FT **£269.00**
80 cps with friction and tractor feed. A reliable printer, competitively priced.
- Epson FX80 **£379.00**
- Canon PW 1080 A **£339.00**
160 cps with near letter quality printing including friction and tractor feed.
- Shinwa CP80 **£199.00**

Colour Monitors

- Microvitec standard 1431 **£199.95**
- Microvitec medium 1451 **£315.00**
- Microvitec high 1441 **£442.00**
- Philips 14" TV/monitor **£235.00**
(RGB Input)

Monochrome Monitors

- Philips 12" Green V2001 **£75.00**

Daisywheel Printers

- Juki 6100 **£375.00**
- Epson DX100 **£450.00***
- SAN PLE 2000 **£299.00**
- *Previously £499.00 **Limited Stock

1½ metre length leads for BBC Micro **£8.00**

All prices include VAT.

Please add £8 for carriage.

We also stock other computer peripherals, accessories and complete work processor systems at unbelievable prices.

Please call for our latest offers.

You may also purchase these items direct by calling at our factory/showroom in Hanwell, London.

Prices correct at time of going to press and offers subject to availability.

Post to: VIGLEN COMPUTER SUPPLIES UNIT 7, TRUMPERS WAY, HANWELL W7 2QA
 Telephone: 01-843 9903. Personal Callers Welcome.
 Please send me (state number required)
 I enclose Cheque/PO. for £ _____
 I prefer to pay ACCESS/BARCLAYCARD (Delete whichever is not applicable)
 Card No. _____
 Signature _____
 Name _____
 Address _____
 Cheques payable to Vigen Computer Supplies
 card holder. Address below must
 be the same as card holder.

MU9/8

THE MICRO PULSE EXTERNAL ROM BOARDS

For the BBC Computer and the Acorn Electron

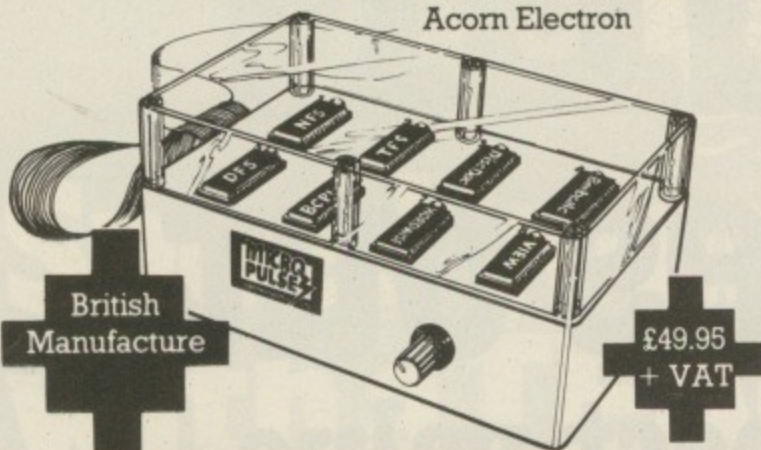

- ◆ BRITISH MANUFACTURE ◆ ALLOWS 8 ROMS ON LINE
- ◆ HARDWARE-BASED ROM SELECTION AVOIDS SOFTWARE INTERACTION BETWEEN UTILITY ROMS
- ◆ SWITCH TO REQUIRED ROM USING MANUAL SWITCH OUTSIDE THE UNIT
- ◆ RED LIGHTS INDICATE THE SELECTED ROM
- ◆ HIT "BREAK" TO ACCESS ROM, NO NEED TO USE SOFTWARE COMMAND
- ◆ INCLUDES ZIF SOCKET, FOR INSTANT CHANGING OF A SELECTED ROM
- ◆ INCLUDES BBC CABLE AND ROM SOCKET CONNECTOR
- ◆ INCLUDES SIMPLE FITTING INSTRUCTIONS, JUST PLUG IN AND GO!

please contact: Gareth Littler
Mark Howard or
Judith Allen at
Micro Pulse
Division



Churchfield Road,
FRODSHAM
Cheshire WA6 6RD
Tel: 0928 35110

ADVERTISERS INDEX

A & F Software	92	Micro-Z	172
ACK Data	184	Microdis	156
Acorn	80	Microfax	184
Acornsoft	32-35	Micromax Computers	156
AMS	70	Micropower	135, 196
Aries Computers	166	Micro Resources	136
Banana Computers	167	Microtest	78
Beebugsoft	20, 21, 96, 97	Microvitec	15
Bel Tech	130	Microware	65
Brother	86	Mighty Micro	167
Bugbyte	15	Millsoft	174
C-Tech	74	Mira Systems	190
C J E Microcomputer	183	Multiplex Computers	160
Cambridge Applied Tech	163	Musicsoft	156
Cambridge Computer Store	145	MW Systems	122
Cambridge Microprocessor	146	National Micro Centres	168-169
Carson Developments	142	Newark Video Centre	172
Chaddington	184	Northern Computers	190
Chase Data	72, 73	Optima Software	84
Clares	48, 49	Opus	43, 52, 58, 151
Commotion	150	P&H Electronics	129
Computerama	3	Pace	121
Computer Concepts	77	Panda soft	163
Computer Room	172	Park Software	163
Consumer Electronics	22	Printerland	170
Contex Computing	154	Proxima Software	90
Cumana	95	Qual-Soft	131
D A Computers	167	Quinkey	158, 159
Data Efficiency	67	Ricksoft	90
Datapen Microtechnology	145	S.P. Electronics	167
Datastar Systems	154	SCI (UK)	44
Dataware	153	Silent Computers	145
Disco-Tech	14	Simonsoft	10
Disking	16, 17	Sir Computers	120
Duckworth	163	Skywave Software	142
Electrolink	184	Small School Software	172
Electronequip	60, 61	Soft Option	174
Epson	141	Softeach	149
GCC (Cambridge)	54	Software Division	167
Gemini	100, 194	Solidisk Technology	12, 13
GSL Computing	110	Spider Systems	150
Guardian Software	160	Stack	109
HCR Electronics	170	Statacom	146
Halewood	160	Superior Software	2, 6, 195
Haystack Peripherals	160	System	46
HMV	7	Systematics	176
Home & Business Computers	151	Tatung	31
Intec	124	Tech Op	94
J & W Bunce	174	Technomatic	8, 9, 11
J P Magnetics	167	The Computer Room	172
Kay-Ess	109	Torch Computers	18, 19
Kosmos	153	Tutorial Software	90
Leigh Computer Systems	153	United Disk Memories	141
Level 9	101	Universal Communication	134
Lifelong Learning	160	Upgrade Technology	181
Lincoln Microsystems	132	Vampyre Software	85
Logical Educational	174	Viglen	185-189
LVL	68, 69, 83	Vine Micros	66
M-Tech	154	Vision Products	163
Mayfair Micros	163	Voltmace	55, 128
Merlin Computer	62	Watford Electronics	36-42
Micro Resources	136	Wildings	149
		Wise-Owl	131
		Wizard Developments	136

THE MICRO PULSE 5.25" DISC DRIVES

ANNOUNCEMENT

- * Northern Computers announce 6 new models of Micropulse 5.25" disc drive, manufactured and assembled in the North West, for the BBC computer. These drives are exactly compatible with the two Acorn/BBC disc formats. They are based on the highest quality Teac mechanisms with built-in power supply, as previously supplied by Cumana Ltd.

* Prices from **£119.95** + V.A.T.

* Also: High Quality 3" Compact Disc Drives

* Prices from **£129.95** + V.A.T.

* Each Micropulse disc drive is supplied with a BBC cable, formatter utility disc and comprehensive 55page disc filing system manual for the BBC computer.

* For further details send large S.A.E. to :



Northern Computers,
Churchfield Road,
FRODSHAM
Cheshire WA6 6RD
Tel: 0928 35110

MIRRA

● MACHINE CODE INTERPRETER 8k EPROM £13.50. Single step/set breakpoints in ROM/RAM. View/Edit/Disassemble/Move/Relocate. Allows 2 sets of key definitions. Lists program variables. Optional security system. (Enclose 5 digit password.)

● UTILITY DISC £9.00. Search and replace. List PROC/FN with line No View memory. On screen edit. Load/save to and from any disc sector. Cure bad programs etc.

● MASTER DISC £8.00. Step through disc sector by sector. On screen editing of any sector. View unlistable programs. Retrieve deleted files etc.

● Both the above on one disc £13.00.

● TERMINAL Cassette £6.00. Disc £8.00. Split xmit. and rec. Baud rates. Parity, stop and word length. Spool and Exec files. 40/80 chars. Split screen facility. Xon/Xoff protocols.

Save and load configuration. Printer control.

SAE for full details of all the above. All prices include VAT and P&P.

WE ARE ALWAYS INTERESTED IN ORIGINAL
GAME/UTILITY/BUSINESS PROGRAMS WHY NOT SEND US
YOURS. A QUICK DECISION
ALWAYS GIVEN.

MIRRA SYSTEMS, 24 Kirkstone, Rugby, Warwickshire, CV21 1PV.

Also available at The Micro Centre, Regent Street, Rugby.
All programs require 1.2 OS. Discs require Acorn DFS.

Now No. 1 BBC
game on Micro Deal
Top Fifty chart

YOU can go for gold

...with the



Fancy pitting yourself against the world's best at this summer's Olympics?

You can do so without going anywhere near Los Angeles – with the most challenging package of programs of 1984.

MICRO OLYMPICS is more than a game. It's a brilliantly written collection of ELEVEN track and field events.

And because we know we're going to sell many thousands of them we've brought the price right down – to just £5.95.

Ever imagined yourself as another Seb Coe? Then try to run against the world record holder at 1500 metres. And if that distance is too much for you then there's always the 100, 200, 400 and 800 metres to have a go at.

Not much good at running? Don't worry, MICRO OLYMPICS has many more challenges for you. Why not try your skill at the high jump or the long jump?

And if you can't beat the computer at running or jumping then you can always throw things around in frustration! The trouble is that it's just as hard to be a champion at the discus, the hammer or the javelin.

And the pole vault takes the event to new heights!

Yes, it's fast, furious fun, pitting yourself against the world's best times and distances on your micro.

You may not be another Steve Ovett or Alan Wells, but with practice you COULD become the Micro Olympics Champion!



Also available from WH Smith
and all other leading stores



Play Micro Olympics
– and let your fingers
do the running!

Send for it today

Please send me _____ copy/copies of
Micro Olympics

I enclose cheque made payable to
Database Publications Ltd.
for £ _____

I wish to pay by

Access Visa No. _____ Expiry date _____

Signed _____

Name _____

Address _____

- | | |
|--|-------|
| <input type="checkbox"/> BBC 'B' cassette | £5.95 |
| <input type="checkbox"/> Electron cassette | £5.95 |
| <input type="checkbox"/> BBC 40-track disc | £7.95 |
| <input type="checkbox"/> BBC 80-track disc | £7.95 |

Please tick box

Post to: Micro Olympics offer, Database Publications,
68 Chester Road, Hazel Grove, Stockport SK7 5NY.

THE MICRO USER

It's the biggest, brightest, most authoritative yet completely independent guide to the machine with so much potential you'll never tire of reading about its remarkable capabilities.

You can buy *The Micro User* from your local newsagent or station bookstall. Or fill in the coupon opposite – your copy will then be delivered to your door each month.

Copies of *The Micro User* back issues are still available at £1.50 each

Cassette tapes and discs of Micro User Programs

Take our a year's subscription and have your cassette or disc posted to you each month. Start your subscription from any You can order on the coupon opposite. Contents are listed below:

MARCH 1983: Deathwatch, a superb arcade game. Bingo, clever uses of the randomise function; Bubblesort routines; Tests function keys in machine code. 0.1 Colour and Graphics Routines: create a kaleidoscope of screen designs.

APRIL: King Kong, rescue girls from the Empire State Building before killing Kong. Nim, a structural game of strategy. Tokens, unravel the Basic ROM; Formatter, an essential disc utility; Disassem, a full machine code disassembler.

MAY: Air Strike, a fast and furious arcade game; Test your mental powers with Pelmanism; Anagrams, the word game. Character, generate vertical and inverted text. Teletext, animation in Mode 7. Beeb, two joystick exercises.

JUNE: Space Pilot, lost in space you must fight off repeated attacks from alien life forms. Nomism, you are a nomadic herdsman desperately trying to eke out a living on the plains of Africa. Colourful Characters Plus other listings from the June issue.

JULY: Tenpin, a simulation of Tenpin Bowling; Spacepods, beat the alien hordes; Cup, exciting 3D graphics techniques. Test and Steady, programs to accompany the Beeb Body Building Course. Breakfix, don't let Break destroy your precious variables!

AUGUST: Fruities, driven by strange urges you climb the ladders of adventure to risk all in the gardens of unearthly frights. Animation, a suite of programs that really bring your screen alive; Casdisc, the machine code downloader for your disc system; Mode 7 colour routines.

SEPTEMBER: Robin & Marian, rescue Maid Marian from the Sheriff of Nottingham. Galactic Invaders, an exciting arcade game. DFS Benchmarks, 14 DFS test programs. Animation, new techniques. Terminal, connect a BBC Micro to a mainframe.

OCTOBER: Fishing, a compulsive day's angling. Joykey, convert programs to joystick. Pentest and Bellringer, for Micro User lightpens. Contours, an educational program. Link BBC Micros to each other. Plus all the listings from the first Electron User.

NOVEMBER: Goblins, an enchanted journey. Blackjack, the casino favourite. Charge and Pendulum, Body Building Course part 9. Sideways, programs in ROMs. Pendraw, a light pen sketching program. Plus all the programs from the second Electron User.

DECEMBER: Tower, rescue London's treasure. Santa, help Father Christmas. VDU 23, an invaluable character defining utility. Paged, graphic techniques.

TAPES
£3.75
each

DISCS
£5.75
each

BBC
MICRO
USER



Deathwatch
and 24 other programs
in the pages of

BBC
MICRO
USER

SPACE PILOT

and other programs listed
in the pages of
BBC Micro User
Vol. 1, No. 4.

THE
MICRO
USER

FRUITIES



and other
programs listed
in the pages of
The Micro User
Vol. 1,
No. 6

THE
MICRO
USER

Robin
and
Marian

and other
programs listed
in the pages of
The Micro
User
Vol. 1,
No. 7

THE
MICRO
USER

COME
FISHIN'

and other programs
listed in the pages
of The Micro User
Vol. 1, No. 8

THE
MICRO
USER

Goblins
and
Blackjack

and other
programs listed
in the pages of
The Micro User
Vol. 1, No. 9

THE
MICRO
USER

Tower
Bridge

and other programs
listed in the pages
of The Micro User
Vol. 1,
No. 10

Plus all the listings from the third issue of Electron User.

JANUARY 1984: Barrels, an all-action arcade game. Noteplay, an entertaining musical utility. Dump1 and Dump2, multitone screen dumps. All the programs from our Sound, Beginners' and Graphics articles Plus 12 programs from the fourth Electron User.

FEBRUARY: Invasion, the classic arcade game. Frogs, fun for all the family. Engvgen, a logic game. Balance, a number learning program. Key, single key entry for the BBC Micro Plus nine other programs from *The Micro User*.

MARCH: Mazemunch, block-

busting arcade action. Birthday, family fun for our anniversary. Derrick, number fun for infants. Pixelpen, high resolution for lightpens. Loadtape, a recovery utility. Plus 18 other programs from the pages of *The Micro User*.

APRIL: Microgolf, the simulation. Eastermaze and April Fool, seasonal games. Seawall and Magic Square, maths fun. Filer and Album, a database of sounds. TRX1, TRX2, RS243 driver. Heartrate, monitor your fitness.

MAY: Dug Dig, asteroid adventures. Damraider, naval action. Enavid, easy envelopes. Steppers, Body Building motor control. Spiro, graphics windows. Adventure, a trapdoor maze. Remember,

program utility. Bigletter, large type. Memory, RAM efficiency.

JUNE: Roadracer, 3D driving action. Quadline, four-in-a-line logic game. Monitor, machine code debugging routines. Toolkit, 8271 disc controller explored. Areas, easy maths. Spell, spelling education. Spokes, beautiful graphics.

JULY: Doomrun, deep space drama. Backgammon, the classic board game. Keys, user defined key editor. Save? and Tidisk, disc utilities. Alice1 and Alice2, mini-adventures. Terminal1 and Terminal2, two communication programs. Acoustic, software for the Body Build Modem.

AUGUST: Castle, an enthralling adventure program. Gridman, a high speed game of strategy. Tedit, a superb Teletext editor. Dsquare, simple number fun. Dedit, a versatile disc editor. Input, the ultimate general input routine. Bells, Alice's mini-adventure. Polygon – high speed graphics.

SEPTEMBER: Villains, save your crystals from the evil onslaught. Rollerball, an intriguing game of strategy and agility. Microterm, communications terminal software. T/Textdump, high quality Mode 7 screen dump. Numbersign, simple number skills test for infants. Fmeter, four body building programs. Alice, another mini-adventure. Video, captions for home video.



Take out a year's subscription NOW!

Make sure you get your copy of *The Micro User* HOT OFF THE PRESS – month after month for the next year.

COMPLETE THIS COUPON TODAY

Your BBC Micro needs protecting!



Our luxury dust cover is made of soft pliable water-resistant transparent vinyl, bound with strong cotton and decorated with the *Micro User* logo in black.

Keep your copies neat and complete

These handsome binders are bound in PVC with the *Micro User* logo in gold blocking on the spine.



MicroSac – the tailor-made tote bag for your BBC Micro

Lots of space for all your equipment – sturdy foam-padded design – easy to carry.

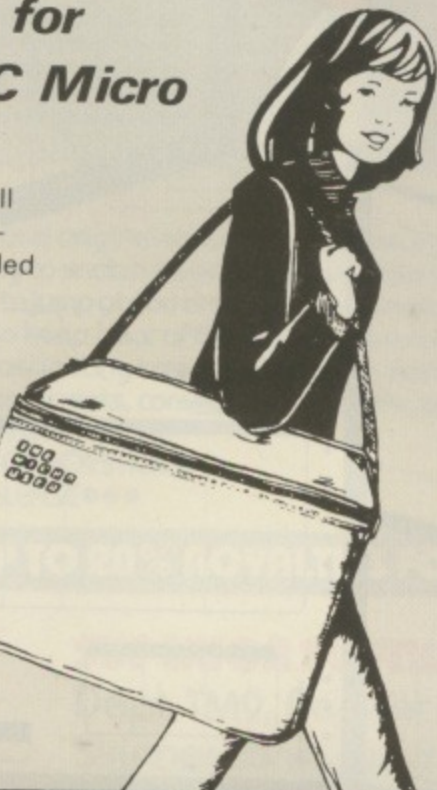

ONLY £19.95 + £1.80 p&p

ORDER FORM

All prices include postage, packing and VAT, and are valid to September 28, 1984

Please enter number required in box

£ p

Micro User annual subscription

UK £15
 EIRE £15 (IR £18)
 Surface mail – Rest of world £20
 Air mail – Rest of world £65

Commence with issue TOTAL

Micro User back issues	March 1983	£1 <input type="checkbox"/>	Jan 1984	£1 <input type="checkbox"/>
	April 1983	£1 <input type="checkbox"/>	Feb 1984	£1 <input type="checkbox"/>
	May 1983	£1 <input type="checkbox"/>	Mar 1984	£1 <input type="checkbox"/>
	June 1983	£1 <input type="checkbox"/>	April 1984	£1 <input type="checkbox"/>
	July 1983	£1 <input type="checkbox"/>	May 1984	£1 <input type="checkbox"/>
	Aug 1983	£1 <input type="checkbox"/>	June 1984	£1 <input type="checkbox"/>
	Sept 1983	£1 <input type="checkbox"/>	July 1984	£1 <input type="checkbox"/>
	Oct 1983	£1 <input type="checkbox"/>	Aug 1984	£1.25 <input type="checkbox"/>
	Nov 1983	£1 <input type="checkbox"/>		
	Dec 1983	£1 <input type="checkbox"/>		

Airmail prices on application.

UK Postage 50p per copy (6 or more £2.50)
 Overseas Postage 75p per copy (6 or more £4.50) TOTAL

Annual subscription for tapes and discs*

£40 – Tape
 £70 – Disc

Commence with (state month) TOTAL

Single copies of tapes and discs*

£3.75 – Tape
 £5.75 – Disc

(UK & Overseas)
 *Please indicate which DFS and disc format you require:

- Acorn
- Amcom
- Watford
- 40 track
- 80 track

Other _____

Deathwatch	Mar 1983	<input type="checkbox"/>
King Kong	Apr 1983	<input type="checkbox"/>
Air Strike	May 1983	<input type="checkbox"/>
Space Pilot	Jun 1983	<input type="checkbox"/>
Tenpin	Jul 1983	<input type="checkbox"/>
Fruities	Aug 1983	<input type="checkbox"/>
Robin & Marian	Sep 1983	<input type="checkbox"/>
Gone Fishin'	Oct 1983	<input type="checkbox"/>
Blackjack / Goblins	Nov 1983	<input type="checkbox"/>
Tower Bridge	Dec 1983	<input type="checkbox"/>
Barrel Battle	Jan 1984	<input type="checkbox"/>
Alien Invasion	Feb 1984	<input type="checkbox"/>
Mazemunch	Mar 1984	<input type="checkbox"/>
Microgolf	Apr 1984	<input type="checkbox"/>
Damraiders	May 1984	<input type="checkbox"/>
Road Racer	June 1984	<input type="checkbox"/>
Doomrun/Backgammon	July 1984	<input type="checkbox"/>
Castles of Fear	Aug 1984	<input type="checkbox"/>
Villains	Sept 1984	<input type="checkbox"/>

TOTAL

Dust Covers

£3.95 – Deluxe

(UK & Overseas)

TOTAL

Binders

£3.95 – UK

£5.00 – Overseas

TOTAL

Payment: please indicate method (✓)

Access/Mastercharge/Eurocard

Barclaycard/Visa

American Express

Card No. _____

Cheque/PO made payable to Database Publications Ltd.

TOTAL

Name _____

Address _____

Signed _____

Send to: **Micro User, FREEPOST, Europa House, 68 Chester Road, Hazel Grove, Stockport SK7 5NY.**

(No stamp needed if posted in UK)

Please allow 28 days for delivery

You can also order by phone or Prestel

Any of the goods listed here can be ordered by telephone. Micronet subscribers and other users of Prestel can also use the Prestel Mailbox.

Telephone:
061-480 0171

Prestel Mailbox
 Key Page 77, then send your order to:
614568383
 24 hours

Don't forget to quote your credit card number AND your full address

GEMINI

Integrated Accounting

for the BBC Micro.

Designed for the small to medium sized business user, where speed and efficiency are vital, Gemini Integrated programs are suitable for sole traders, partnerships, or limited companies. All require a BBC B 32K microcomputer, and an 80 column printer.

A double disk drive with an Acorn compatible DFS is required for integrated accounting purposes. A single disk drive may be sufficient where modules are used independently, although this is not recommended for the Sales Ledger and Invoicing module. The manuals indicate the system capacities for various disk drive combinations.

Why Integrated Accounting?

Because it will retrieve information stored in one program for use by another, and store data in one program which has been generated by another.

Why Gemini?

Because our business software for the BBC Micro is based upon the solid foundation of experience. Not only are three of our Directors Chartered Accountants, but we have also successfully written business software for the BBC Micro since it was first launched.

STOCK CONTROL

A program providing full control over every aspect of stockholding operations.

Inventory Master File holding details of part number, selling and cost price, sales and product code, current stock, location of stock, allocated items, re-order level, quantity on order, current period activity and supplier code.

Maximum 980 part numbers on 40 track disk and 1980 on 80 track disk per stock file.

NO SECOND PROCESSOR REQUIRED!

INVOICING & SALES LEDGER

Produces invoices and statements for customers and enables a tight control over credit procedures to be maintained by producing aged debtor reports.

Automatic updating of sales ledger. Can hold up to 135 customers on 40 track disk system and up to 610 customers on 80 track system per Sales Ledger file.

Comprehensive analysis of invoices over unlimited, user definable sales codes.

Price £99.95 per Module VAT inclusive

PAYROLL

Provides a full range of controls over the different aspects of Payroll Accounting including tax and other deductions.

Employee file containing: Name, address, sex, marital status, National Insurance number and contribution type, date of birth, personnel number, department type, date of employment commenced, all applicable tax codes, whether week 1 or month 1 type (cash, cheque or salaried), pay cycle, payment reference number, previous name, bank details. Maximum 50/98 employees on 40 track single/dual disk system and 140/198 employees per Payroll file.

NOMINAL LEDGER

This is the central module of the Integrated Accounting system and may also be used independently as a Cash Book or interfaced with the Sales and Purchase Ledgers and Payroll programs.

143 Nominal accounts all of which are user definable.

Full cash Book facilities.

Print out of full Trading and Profit and Loss Account and Balance Sheet together with notes to the accounts.

PURCHASE LEDGER

Used independently or interfaced with the Gemini Nominal Ledger, the program maintains a complete file for each supplier, records amounts outstanding at any time, helps to determine which invoices are payable, and payment dates for the claiming of discounts.

Comprehensive analysis of invoices over unlimited, user definable expense headings. Maximum number of suppliers on 40 track disk system of 135 and maximum of 610 suppliers on 80 track disk system per Purchase Ledger file.

Pre-Printed Stationery

The following Gemini two-part pre-printed continuous stationery forms are available by completing the order form in the manual: Invoices, Statements, Remittance Advices and Payslips.

Available from:

Larger branches of Boots and W.H. Smith and most good software dealers... or phone Gemini for immediate despatch quoting your Access, Visa or American Express card number. Telephone (0395) 265165/265832. Alternatively make your cheque or Postal Order payable to Gemini Marketing Ltd., and send to Gemini Marketing Ltd., 18a Littleham Road, Exmouth, Devon EX8 2QG.

Please send urgently (specify 40 or 80 track)

Prices stated in this brochure include VAT and Post and Packing (UK only).

Name

Address

Signature

Credit Card No. Access/Visa/American Express (delete)

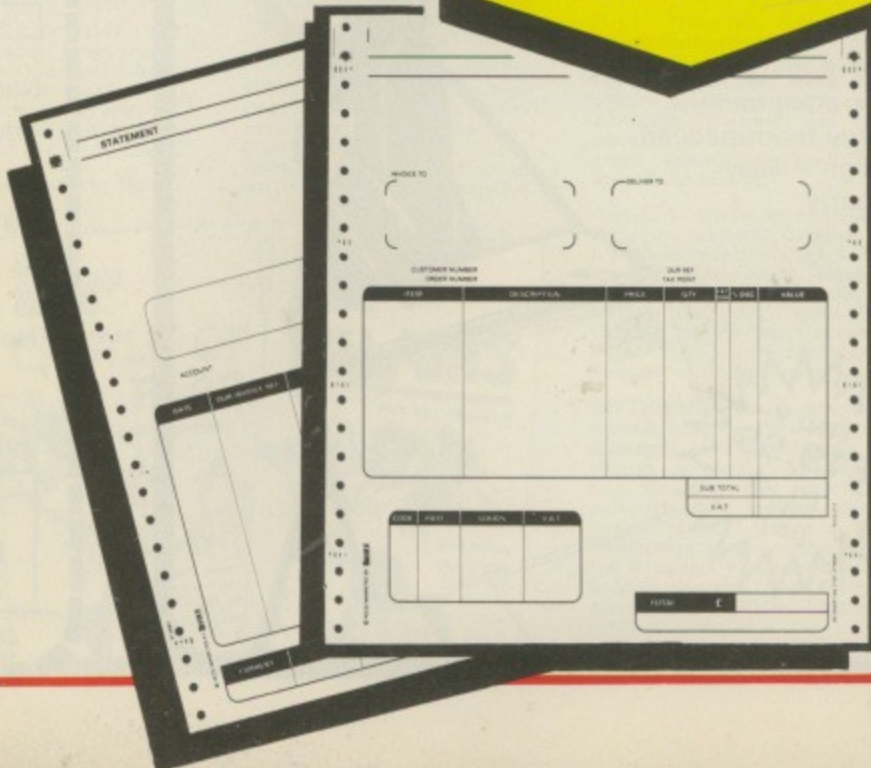

NEW RELEASES

**BBC
MICRO**

SPECIAL OFFER!
Order both
directly from
us and deduct
£1 from each.

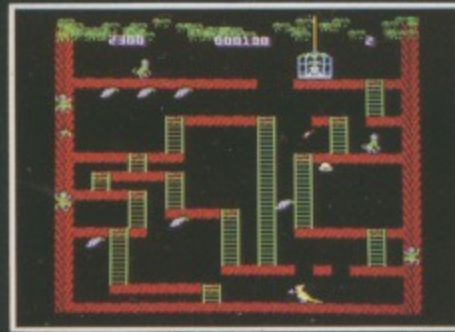
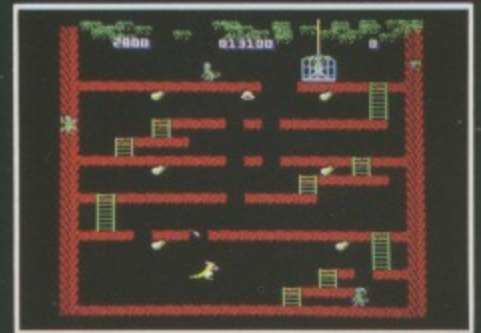
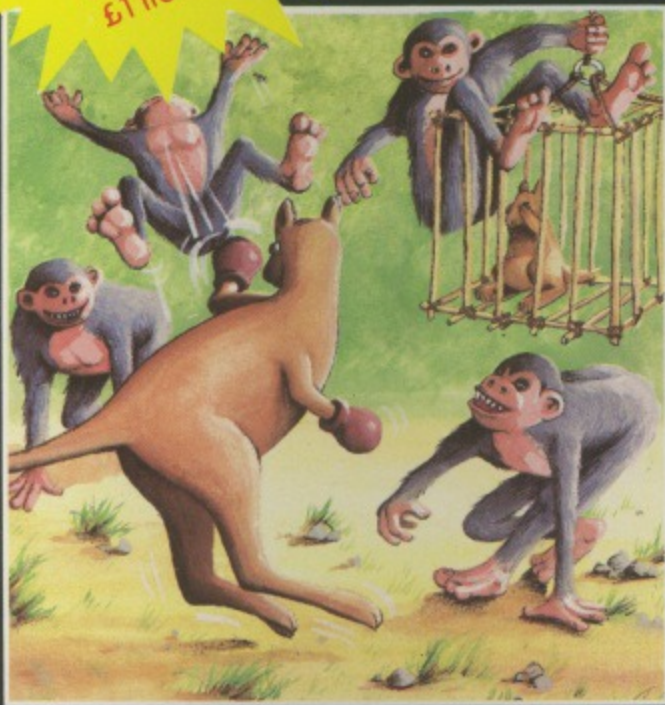

WALLABY (32K)

£7.95

From the author of Overdrive comes another superb arcade-action game. You must guide Wally the Boxing Wallaby up the ladders to rescue the baby wallaby from its cage. The evil monkeys will try to stop Wally in his tracks; he can kill the monkeys by a swift upper-cut, but watch out for the apple-cores which they hurl at him without compassion. Five screens of increasing difficulty with bonus fruit on each level. Yet another winner from Superior Software!

●●●NEW RELEASE●●●



Many of our titles are available in Boots, W.H. Smiths, John Menzies, Rumbelows, Laskys, Currys, HMV, Greens at Debenhams and Spectrum Shops. Also at all major computer dealers — Eltec Computers, Micro Management, West Coast Personal Computers, Microstyle, Electronequip, 3D Computers, Computerama, GTM Computers, etc. Our software is also available through all the major distributors, and directly from us by mail-order.

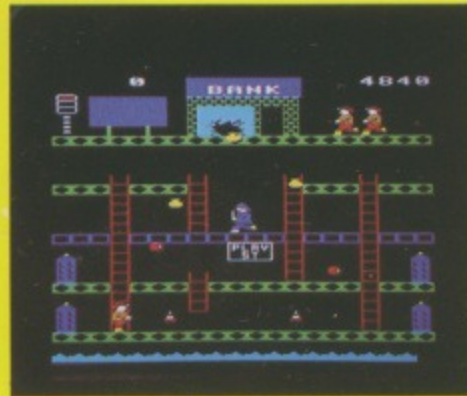

SMASH AND GRAB (32K)

£7.95

An excellent and original arcade-style game in which you take the role of a robber aiming to snatch bags of gold from the bank. A policeman is after you ... he is able to jump at you or squat down and try to hit you with his truncheon. You must also keep clear of the flying police cones and floating dustbin lids. There are 3 fascinating screens of action including play streets with bouncing balls, one-way streets, conveyor belts, traffic lights and police-boxes. A novel and amusing game.

(KEYBOARD OR JOYSTICKS)

●●●NEW RELEASE●●●

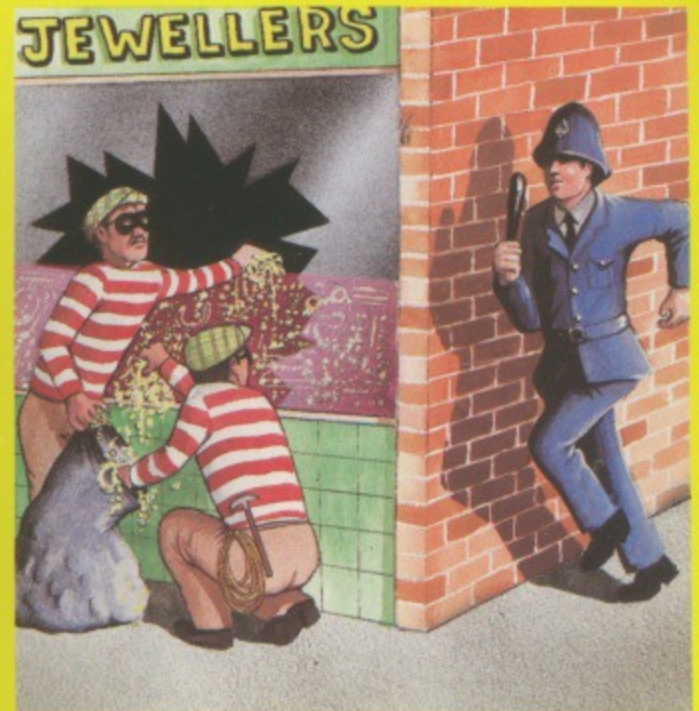

WE PAY UP TO 20% ROYALTIES FOR HIGH QUALITY BBC MICRO AND ELECTRON PROGRAMS.



SUPERIOR SOFTWARE LTD.

Dept. TM9, Regent House,
Skinner Lane, Leeds 7
Tel: 0532 459453

OUR GUARANTEE

- (1) All our software is available before we advertise.
- (2) All our software is despatched within 48 hours by first-class post.
- (3) In the unlikely event that any of our software fails to load, return your cassette to us and we will immediately send a replacement.

M I C R O P O W E R M I C R O P O W E R M I C R O P O W E R M

AN EXCITING NEW BBC MICRO PROGRAM FROM BRITAIN'S LEADING SOFTWARE HOUSE

Rid Dune

Cross the desert wastes of the barren world. Shoot down the Moebian fighters flying overhead and catch the fuel cannisters dropping from enemy tankers. Jump over molten lava pools and blast the radioactive rocks which block your way. Super smooth scrolling landscape and seven types of alien craft.

Only £7.95



AVAILABLE FROM ALL GOOD RETAILERS INCLUDING SELECTED BRANCHES OF:

WRITTEN ANY PROGRAMS?
WE PAY 20% ROYALTIES!

The following top titles are available for both the BBC Micro and Electron: Killer Gorilla £7.95/ Bandits at 3 o'Clock £6.95/Moonraider £7.95/Croaker £7.95/ Felix in the Factory £7.95/Felix and the Fruit Monsters £7.95/ Chess £7.95/Draw £9.95/Escapes from Moonbase Alpha £7.95/ Cybertron Mission £7.95/Swoop £7.95/Intergalactic Trader £8.95/ Positron £6.95/Adventure £7.95/Galactic Commander £7.95/ Danger UXB £7.95/Electron Invaders £7.95/Ghouls £7.95.

SHOWROOM: NORTHWOOD HOUSE, NORTH STREET, LEEDS LS7 2AA Tel: (0532) 458800

MAIL ORDER: MICRO POWER LTD. SHEEPS CAR STREET SOUTH, LEEDS LS7 1AD Tel: (0532) 434006

SPECIAL OFFER: Deduct £1 per cassette when ordering two or more



M I C R O P O W E R M I C R O P O W E R M I C R O P O W E R M

2Dune Raiders

Cross the desert wastes of the barren world. Shoot down the Moebian fighters flying overhead and catch the fuel cannisters dropping from enemy tankers. Jump over molten lava pools and blast the radioactive rocks which block your way. Super smooth scrolling landscape and seven types of alien craft.

Only £7.95



IG SELECTED

John Menzies

Gorilla £7.95/
er £7.95/
ers £7.95/
pha £7.95/
Trader £8.95/
er £7.95/
£7.95

TH STREET,

Accom VISA

AD
der
GSH

g two or more



THE MICRO USER

September 1984

Create home movie titles

Discover the hidden power of the 6502 second processor

LOG-ON: 16 page section on using your BBC Micro to talk to other micros, Prestel... and even Big Brother Mainframe

Vol. 2 No. 7

Independent guide to the BBC MICRO!

THE MICRO USER

